

2023

# İMGESEL ALIŞTIRMALARI



*Düzenleyen: Yılmaz AYDIN*

*Raci Alkır Güzel Sanatlar Lisesi*

*03.03.2023*

Bu kitabın ve benzer  
kitapların PDF  
dosyalarını yandaki QR  
kodu okutarak  
indirebilirsiniz



## İçindekiler

İNSAN FİGÜRÜ ÇİZİMLERİ .....	2
A- Figürde Oran-Orantı .....	2
B- Hareketli Figür Çizimleri .....	6
C – Vücut Parçalarının Çizimi .....	26
❖ Gövde Çizimi .....	26
❖ El ve Kol Çizimleri .....	32
❖ Ayak ve Bacak Çizimleri .....	43
❖ Örnek İnsan Figürü Çizimleri .....	50
ARAÇ VE EŞYA ÇİZİMLERİ .....	69
A- Araçlar .....	69
B- Eşyalar .....	96
HAYVAN FİGÜRÜ ÇİZİMLERİ .....	120
ÖRNEK PERSPEKTİF ÇİZİMLERİ .....	181
A- Figür Ve Mekanların Perspektife Göre Çizimi .....	181
B- Işık Kaynağının Perspektife Göre Çizimi .....	201
ÖRNEK MEKÂN ÇİZİMLERİ .....	206
ÖRNEK İMGESEL ÇİZİMLERİ .....	236

# İNSAN FİGÜRÜ ÇİZİMLERİ

## A- Figürde Oran-Orantı

İnsan figürü çiziminde kullanılan oranlar, kafa uzunluğuna göre belirlenir. Antik çağlardan bu yana yapılan hemen tüm sanatsal çizimlerde oranlar birbirinden farklı görünebilir. Günümüz de bile bu oranlar için kesin ifadeler kullanılamamaktadır. Ancak genel olarak kabul görmüş bazı oranlar vardır, bunlarda genelde bazı sanatçıların içinde buldukları topların fiziki yapısından etkilenmesiyle vuku bulmuştur. Örneğin ekvatora yaklaştıkça insan vücudunun daha minyon yapıya bürünmesi ve kutuplara yaklaştıkça insanların daha yapılı hale gelmesi gibi.

Bazı kaynaklarda normal bir insan vücudu yetişkin birey için 8 kafa uzunluğu olarak belirlenmiştir çocuklarda oranlar daha da farklılaşmaktadır.

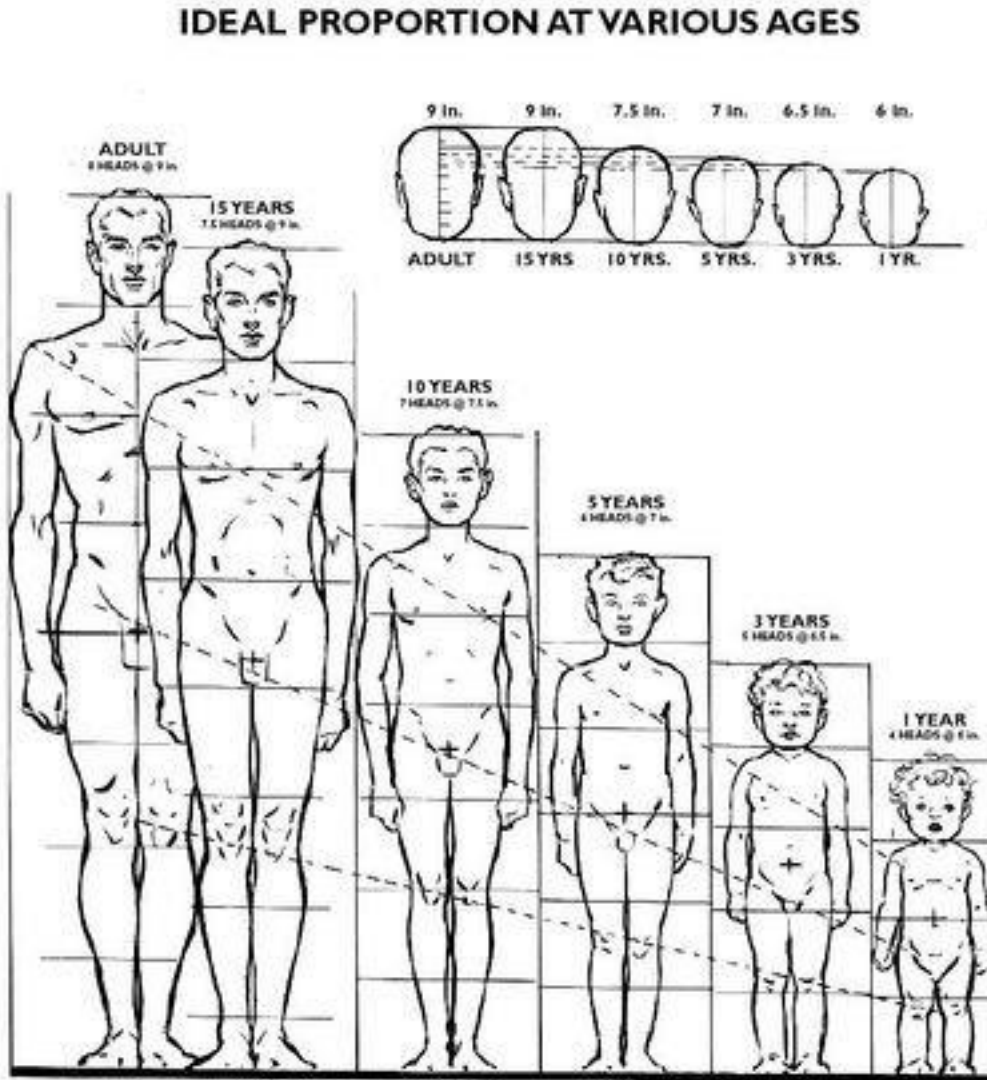

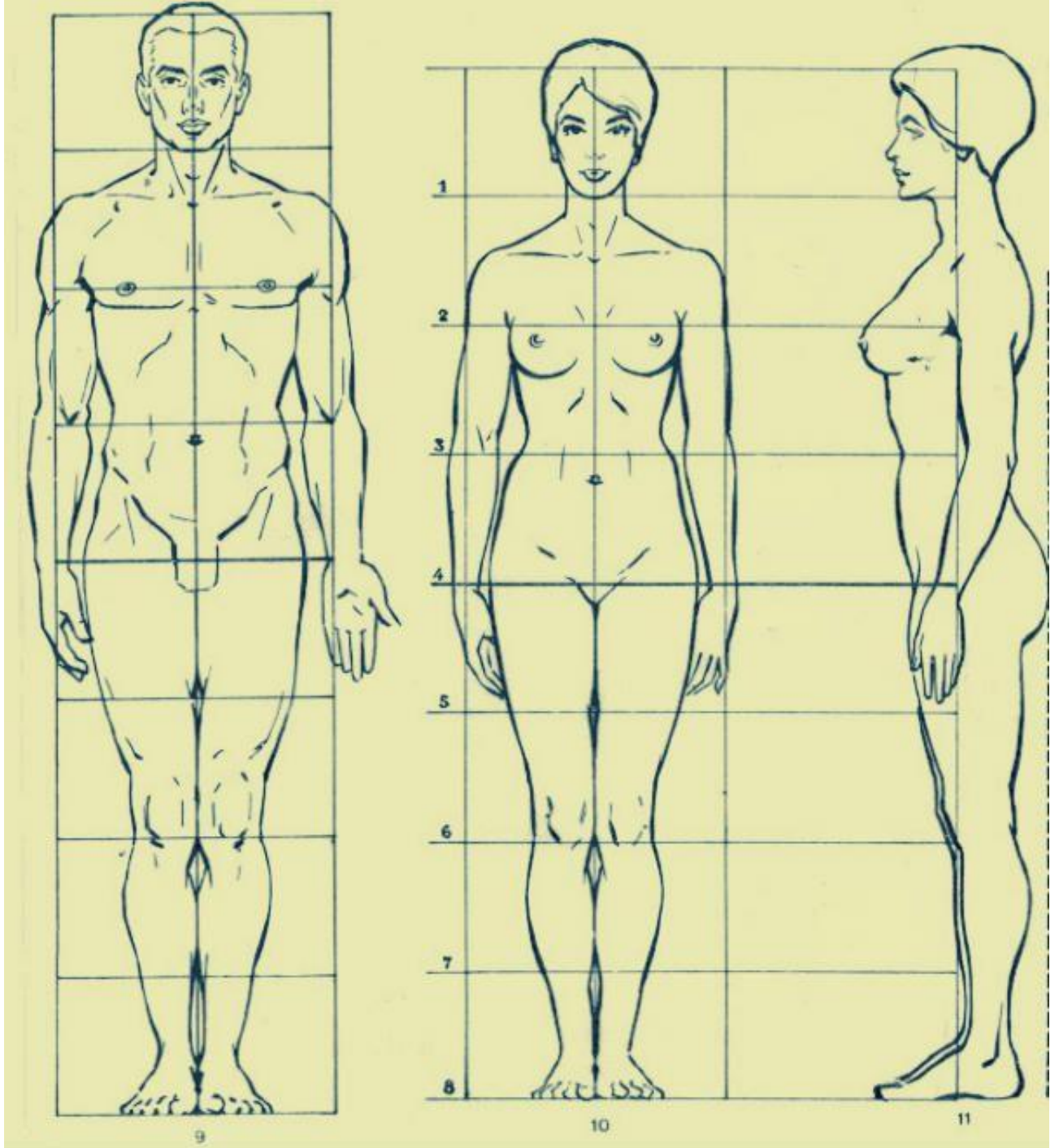

## 8 Heads Body Proportion

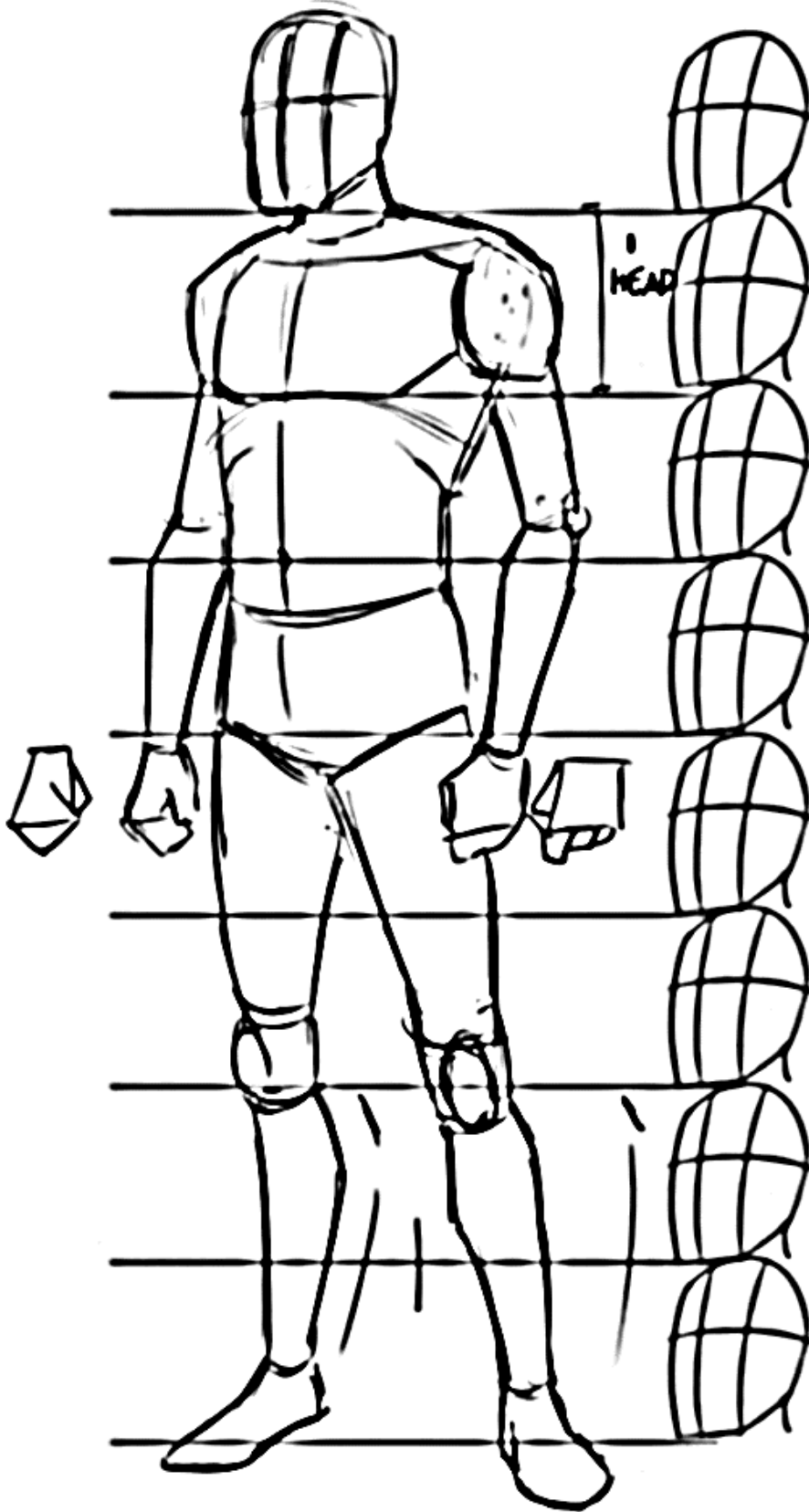

Bazı kaynaklarda ise aşağıda olduğu gibi farklı oranlarda çizilmiştir. Fakat bizim tavsiyemiz de 8 kafa orantısını kullanmanız yönünde olacaktır.

## *HUMAN PROPORTION GUIDE* by hezon sistoza

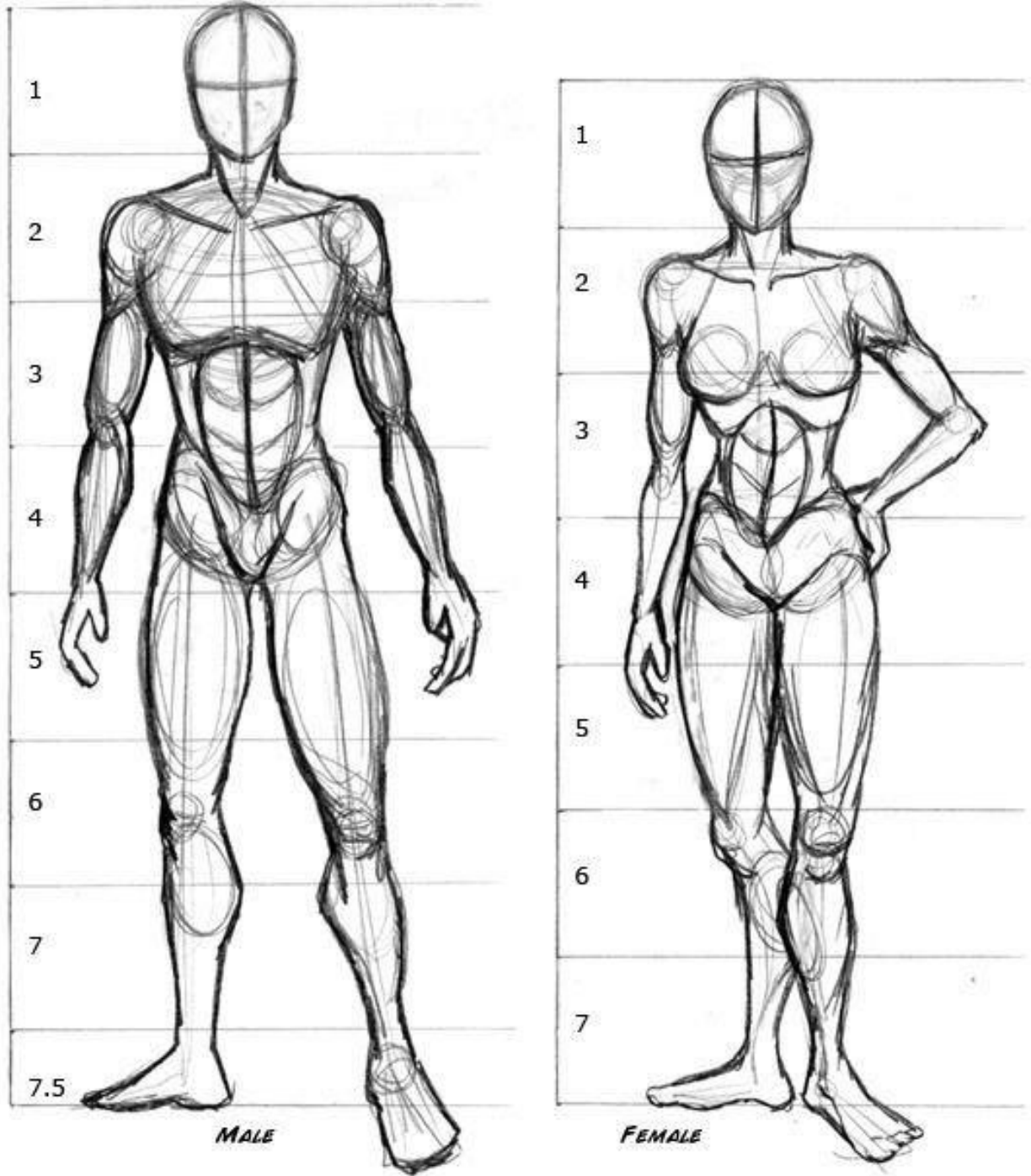

B- Hareketli Figür Çizimleri

Çöp adam yöntemi ile figürlere rahatlıkla hareketler verebiliriz.

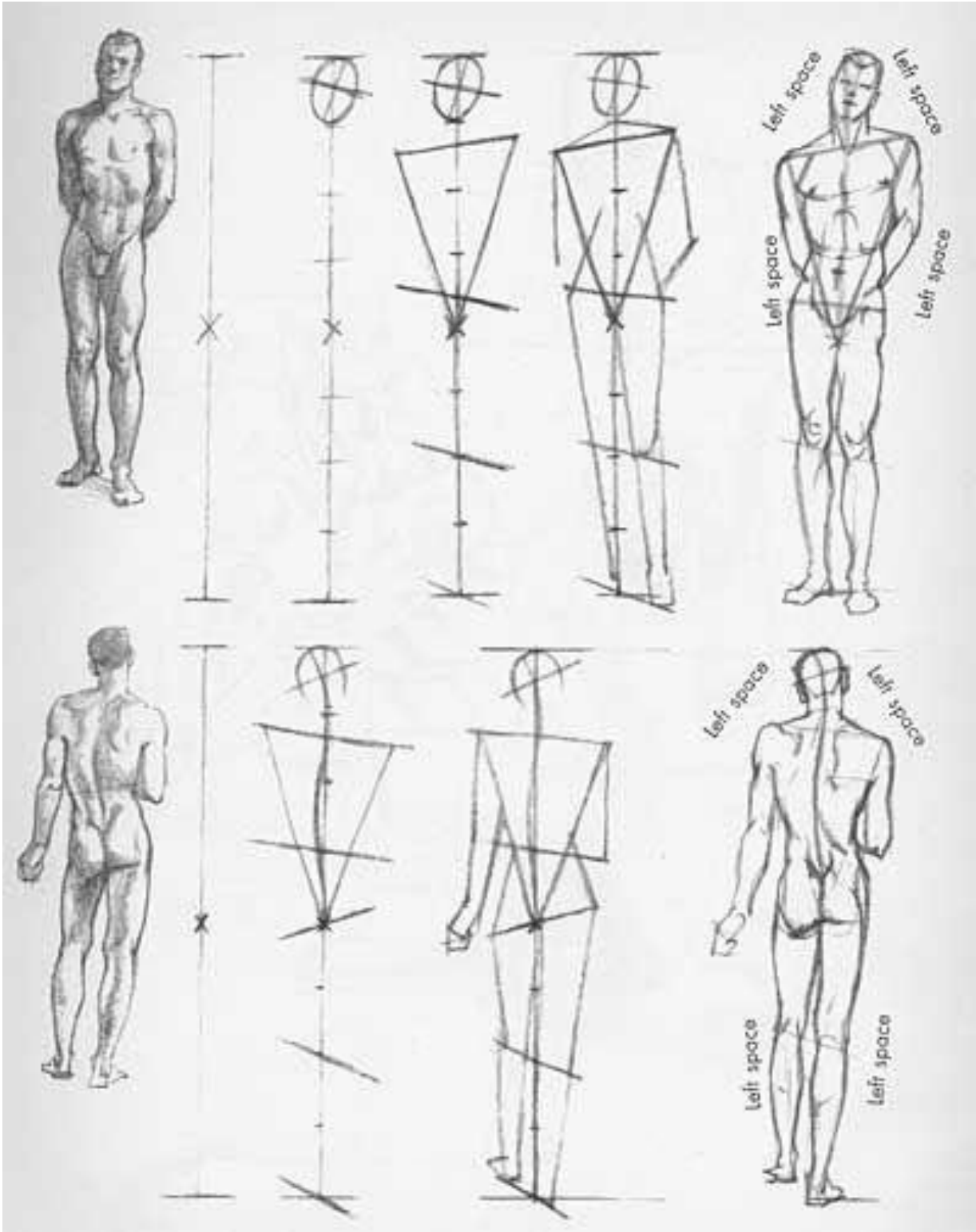

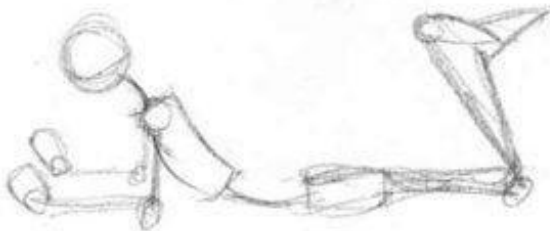
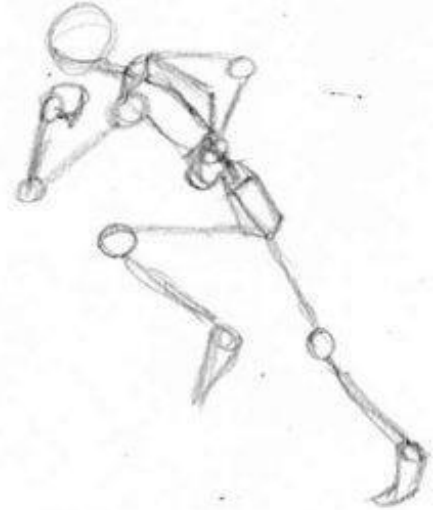
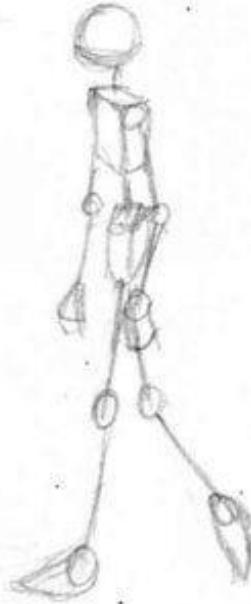
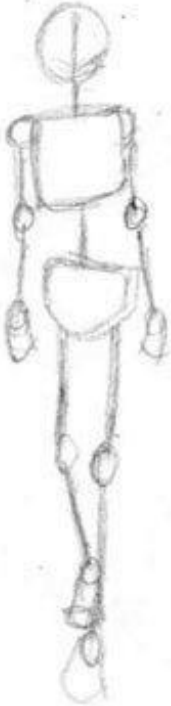
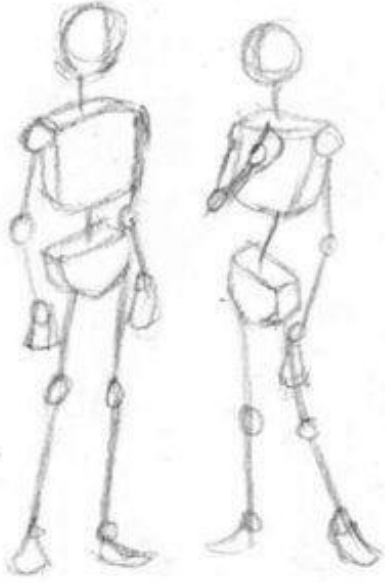



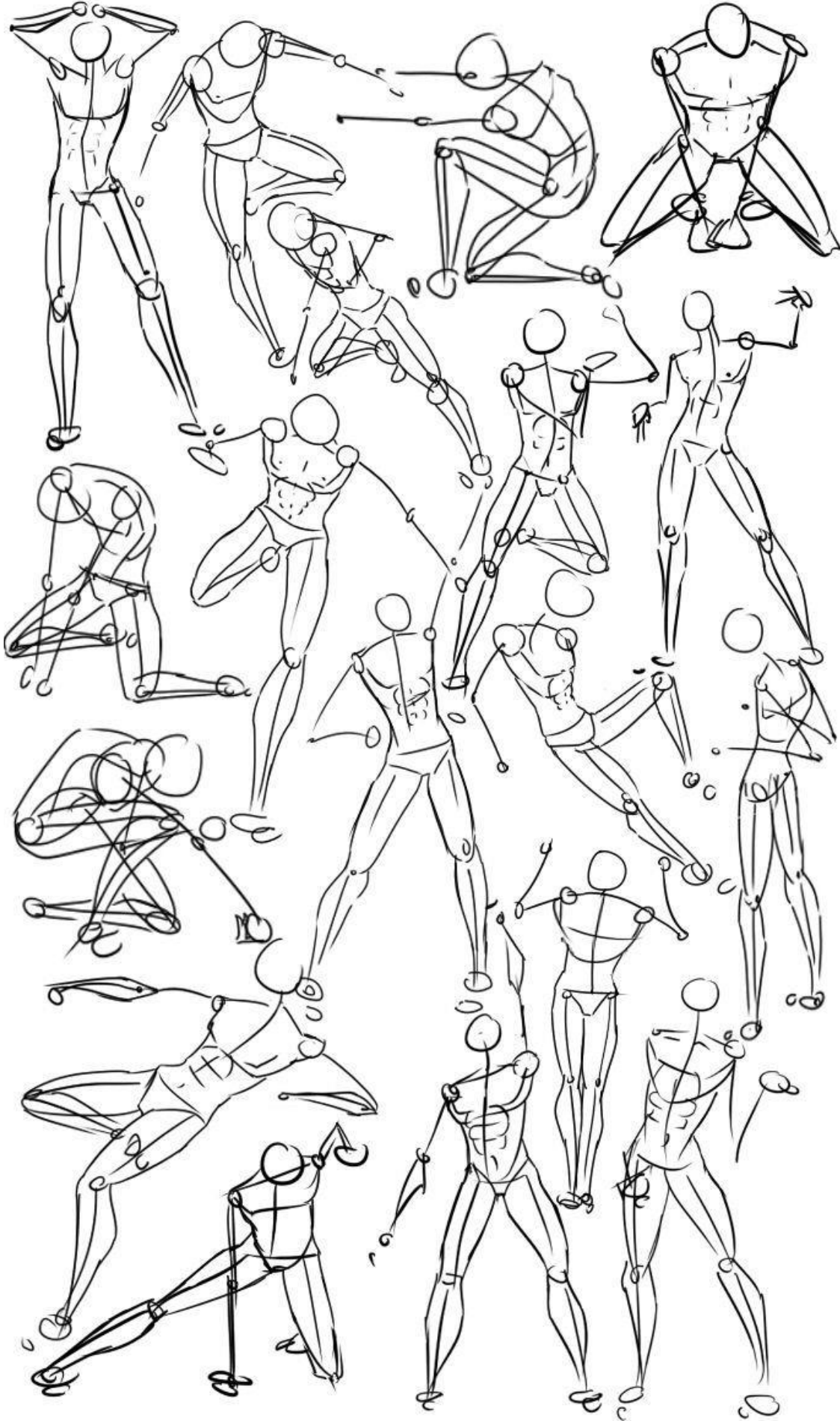

▶ Starla's Art Studio  
📷 @starlas\_art\_studio  
🐦 @ArtStarla

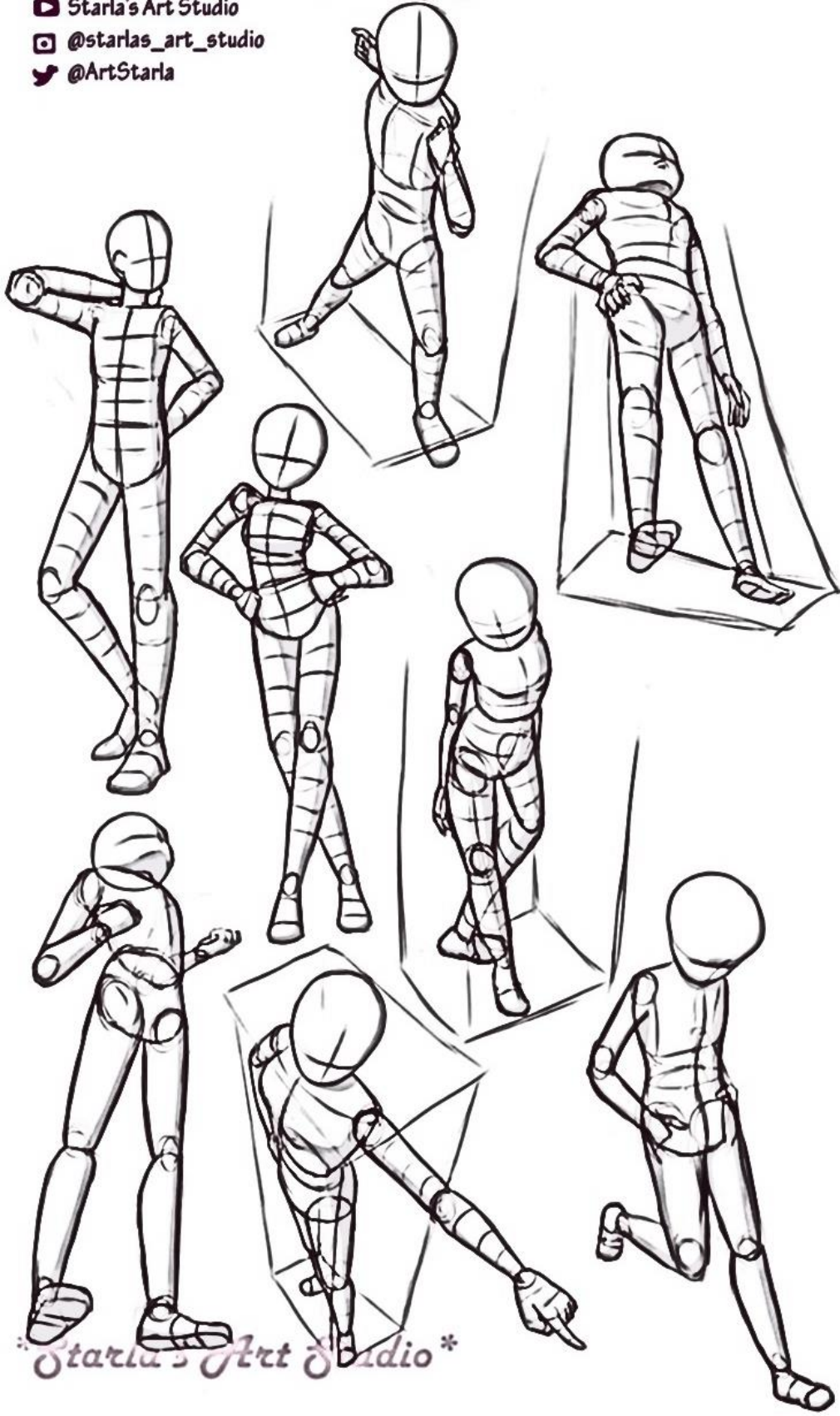

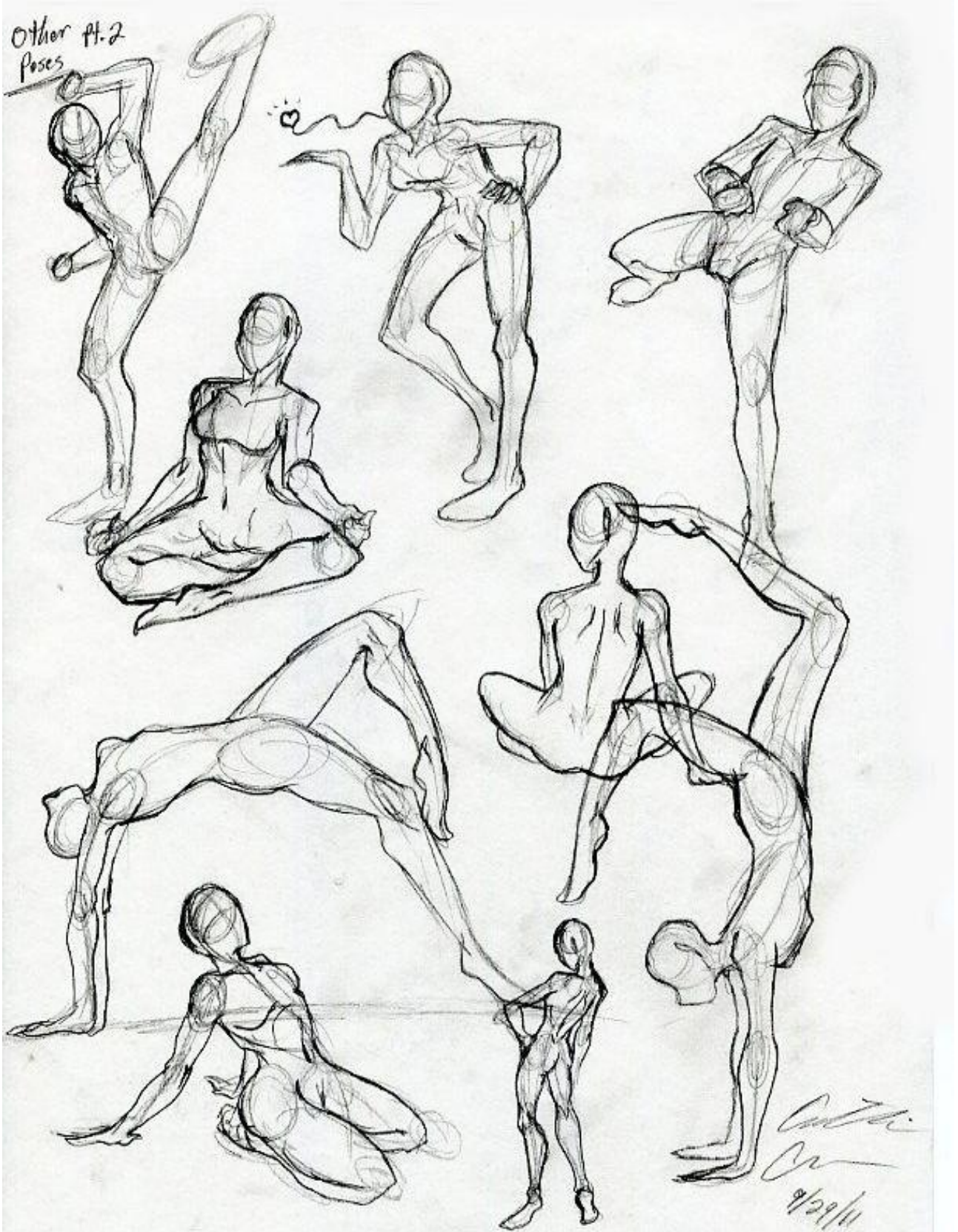







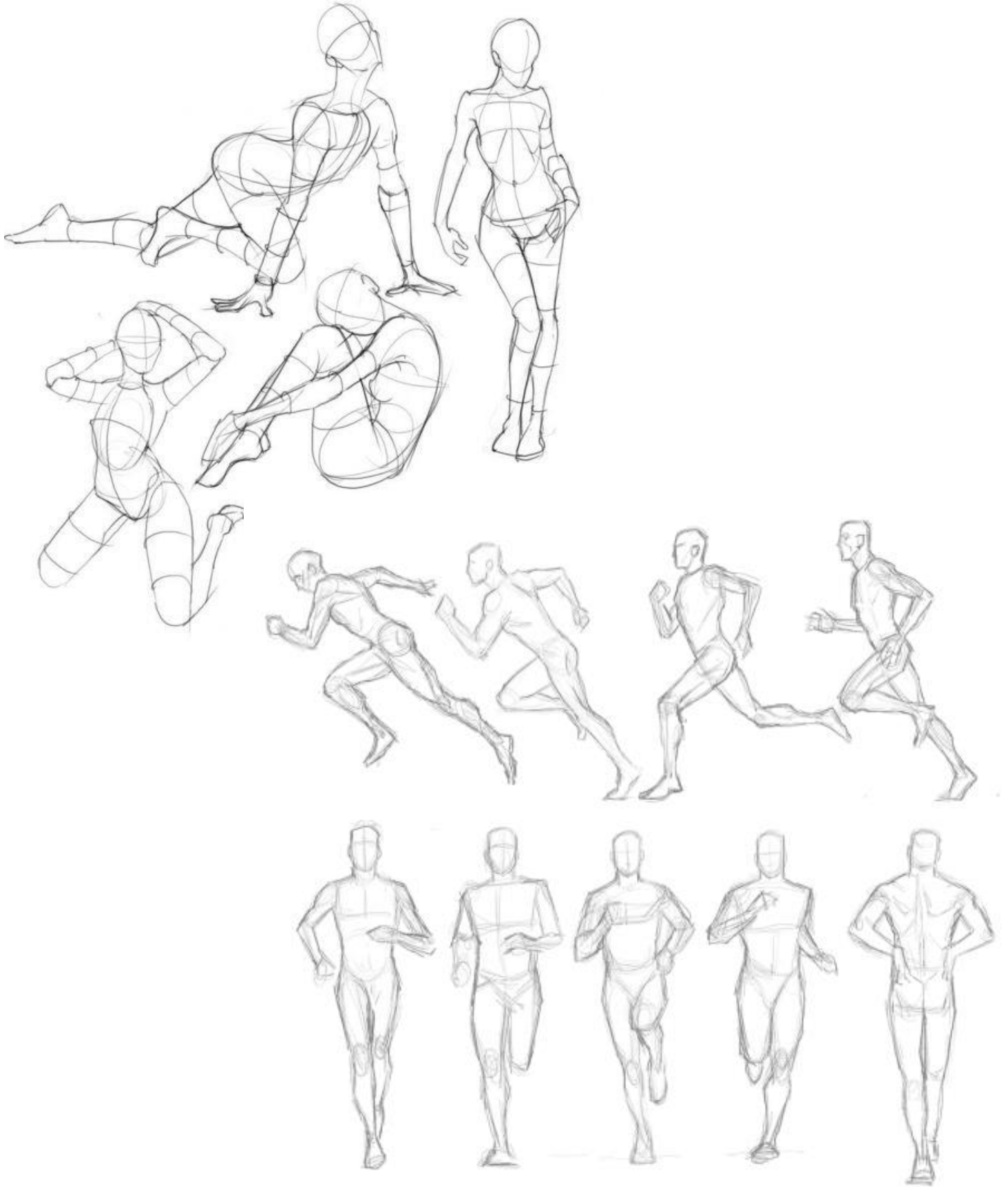

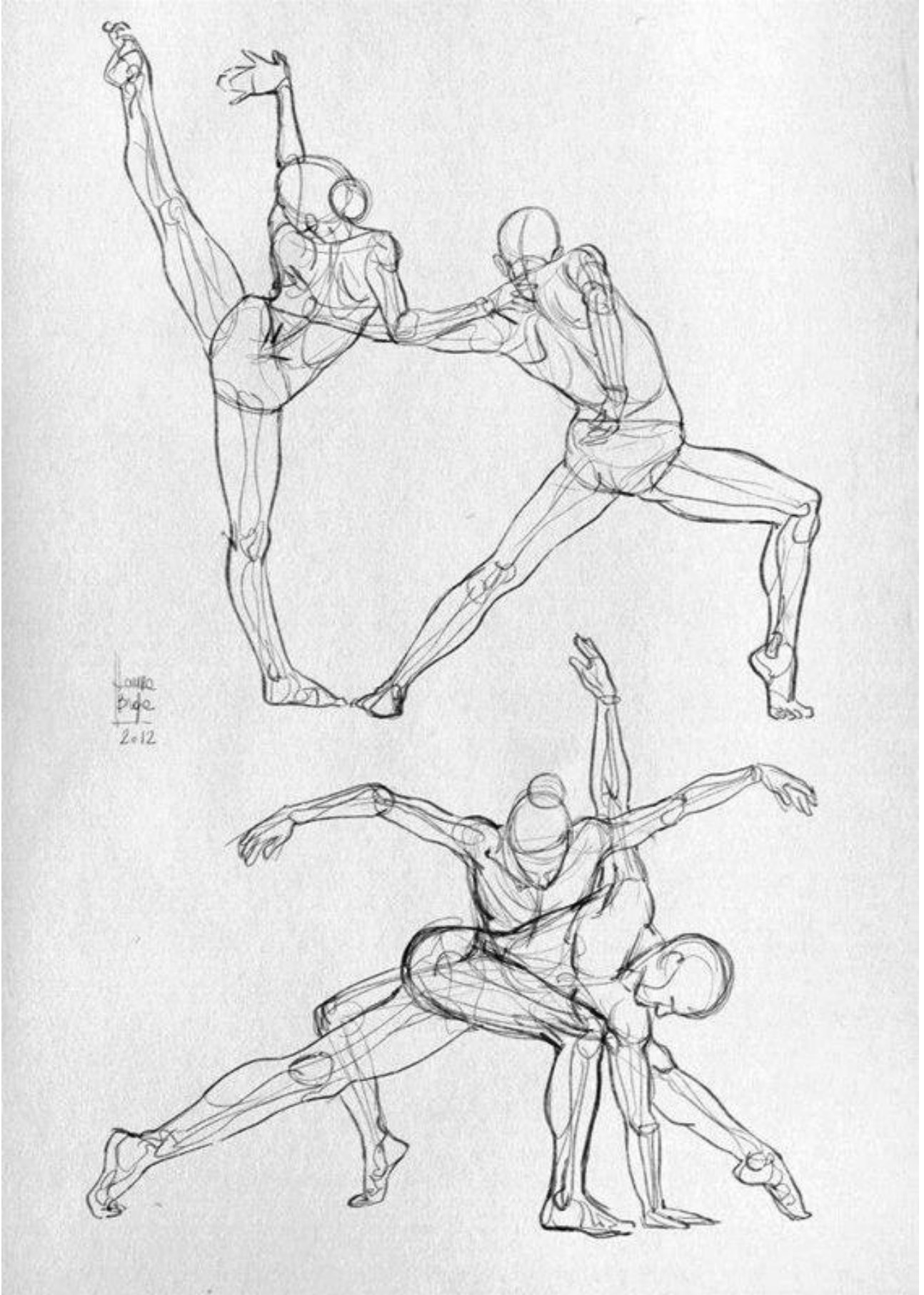







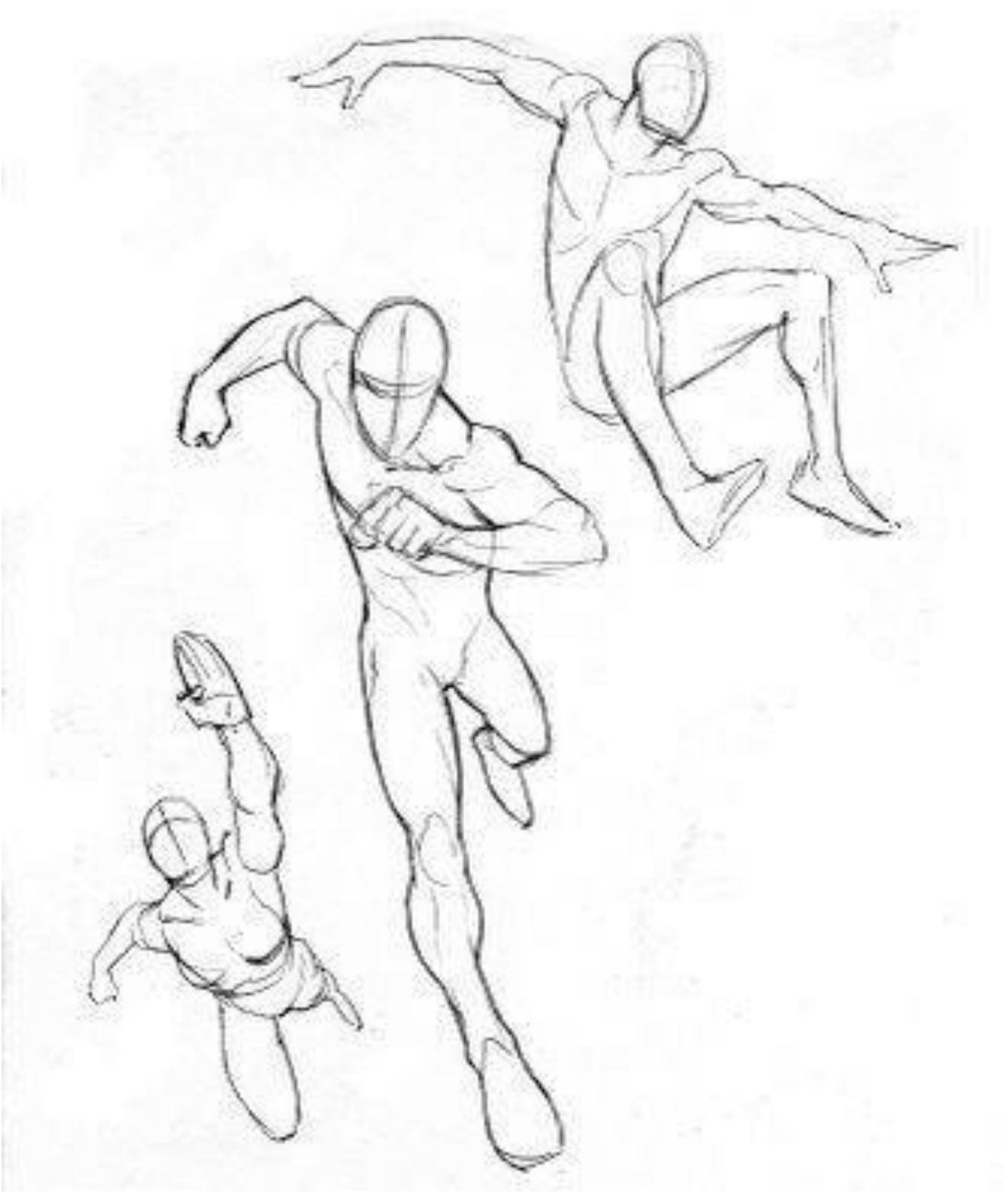



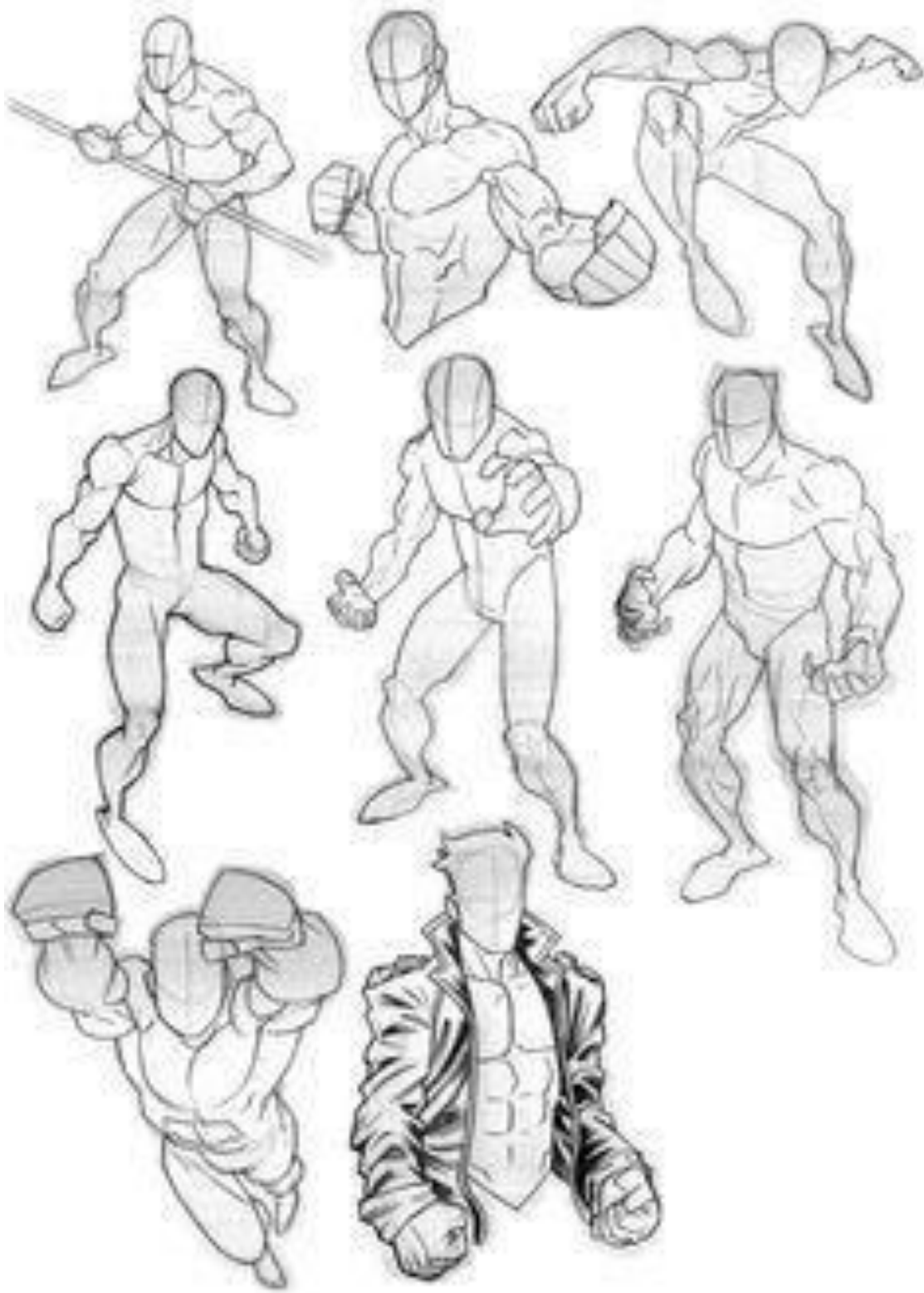

## İMGESEL ALIŞTIRMALARI

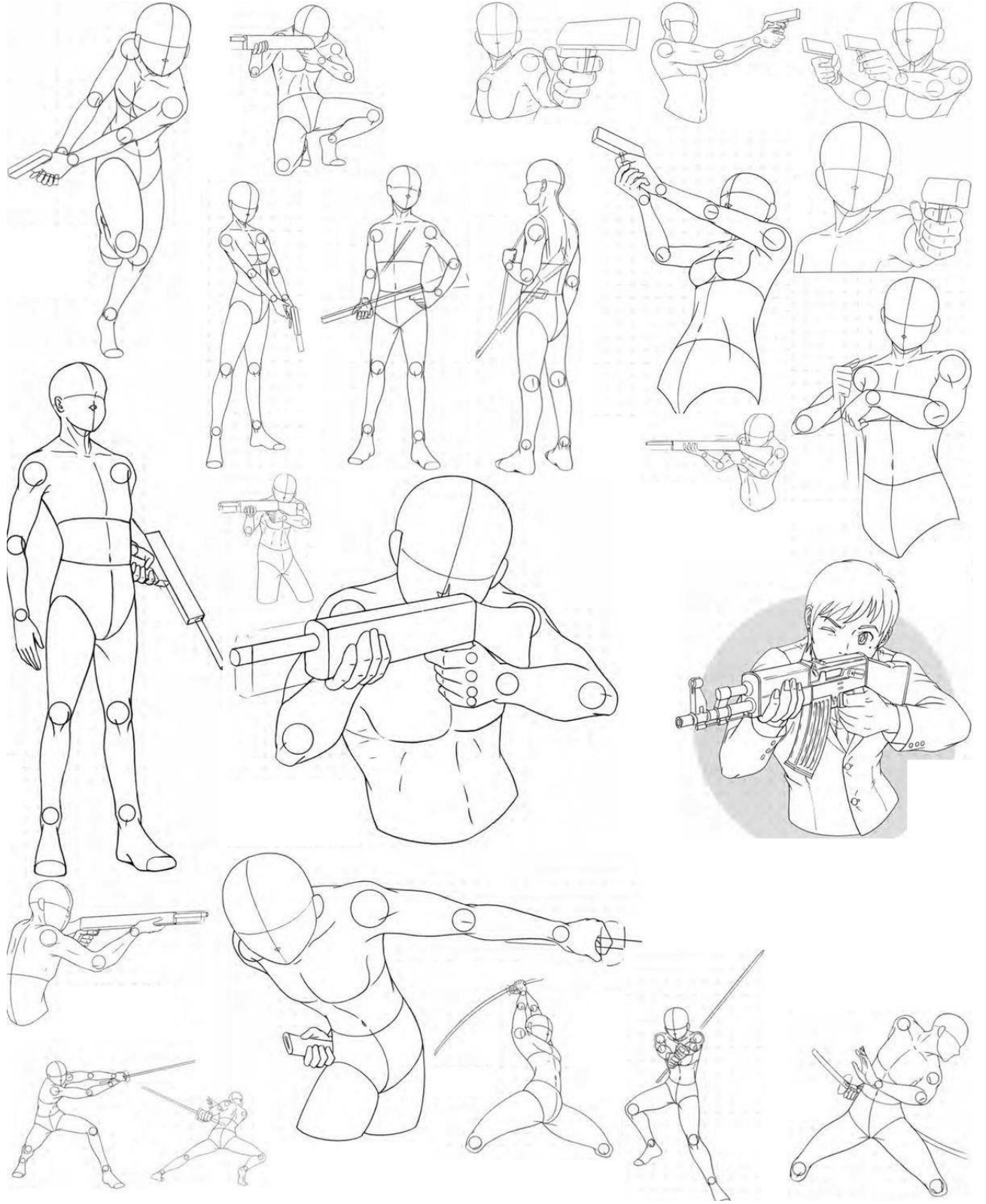



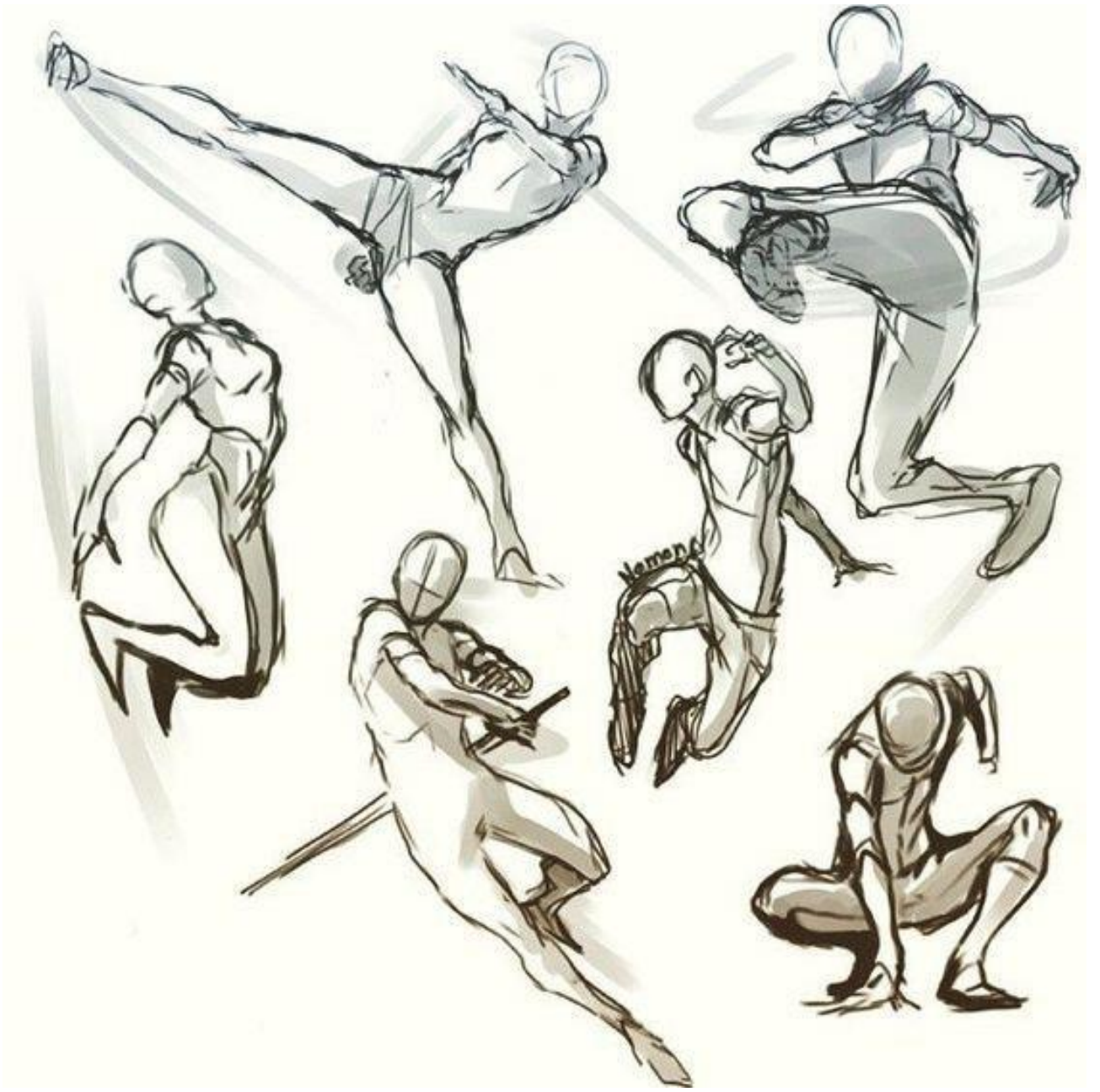



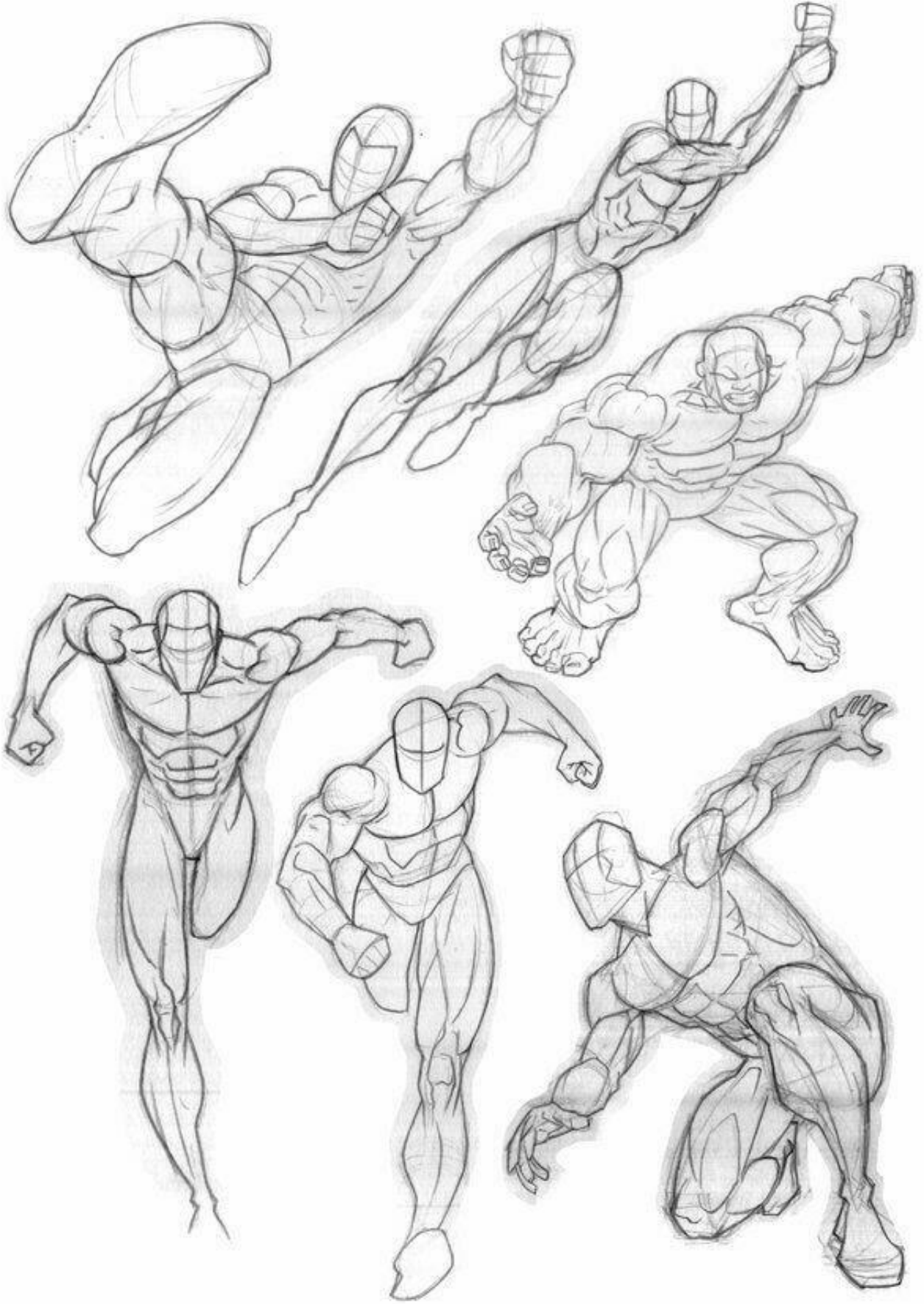

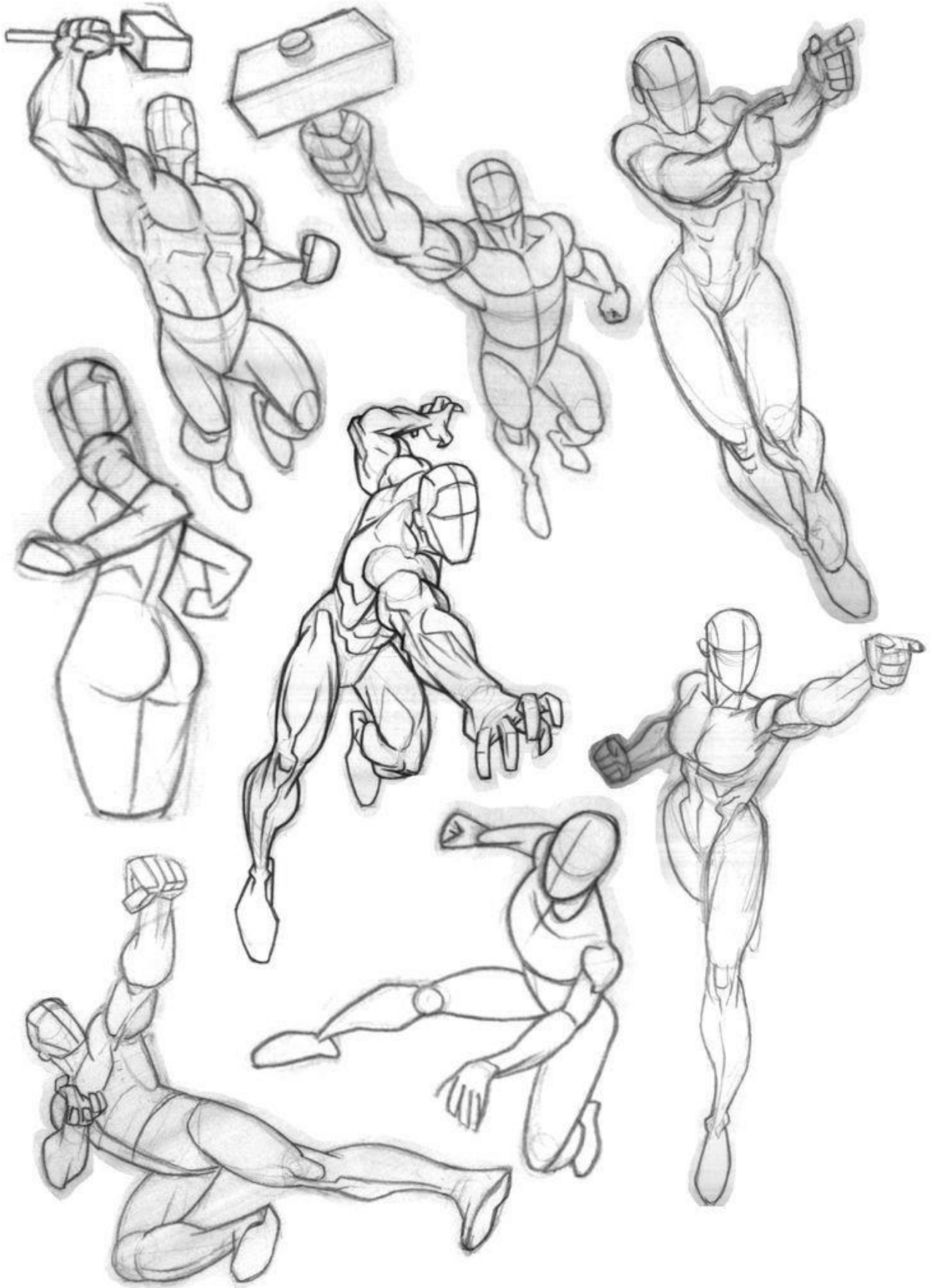

## C – Vücut Parçalarının Çizimi

### ❖ Gövde Çizimi

İnsan figürü çiziminde öncelikle dikkat edilmesi gereken şey cinsiyettir. Anatomik olarak kadın ve erkek vücudu birbirinden farklı özellikler barındırdığı için bu farklılıkları da hissettirmemiz gerekmektedir. Mesela kadınların vücut hatları daha oval yapılara sahipken erkeklerde bu ovallik çok daha azalmaktadır, omuz-bel-kalça kısmında erklerin omuz kısmı kalça ve bel kısmına nazaran daha geniş olabilir istisnai durumlar hariç. Kadınlarda ise kalça daha geniş ve bel daha ince yapıdadır omuz kısmı ise daha yuvarlak hatlarda ve kalçaya göre daha dar resmedilir. Ayrıca erkek vücudu kaslı bir görünüme sahip iken kadın vücudu daha narin bir yapıdadır. Aşağıda ki çizimlerde de örnekleri inceleyebilirsiniz.



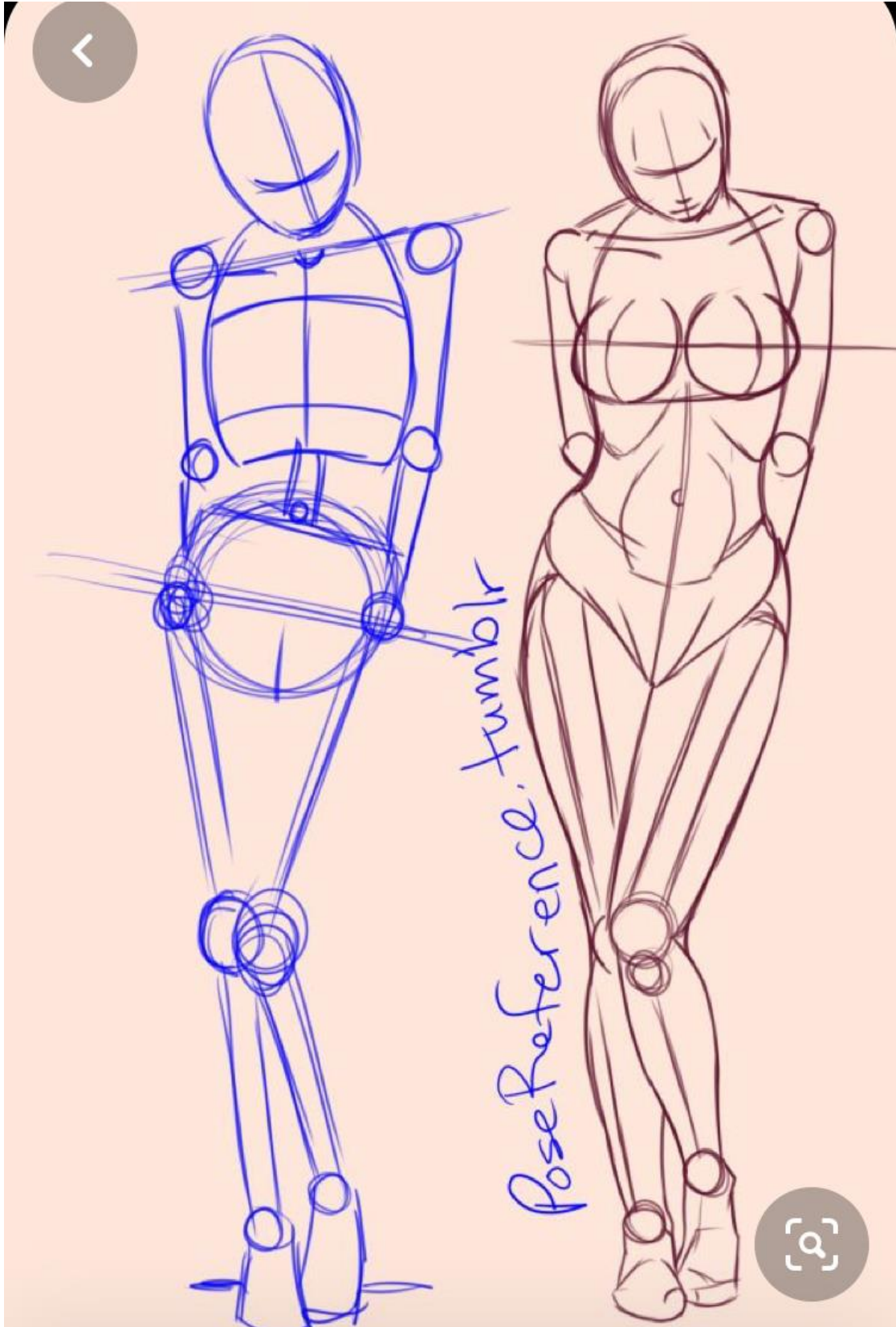

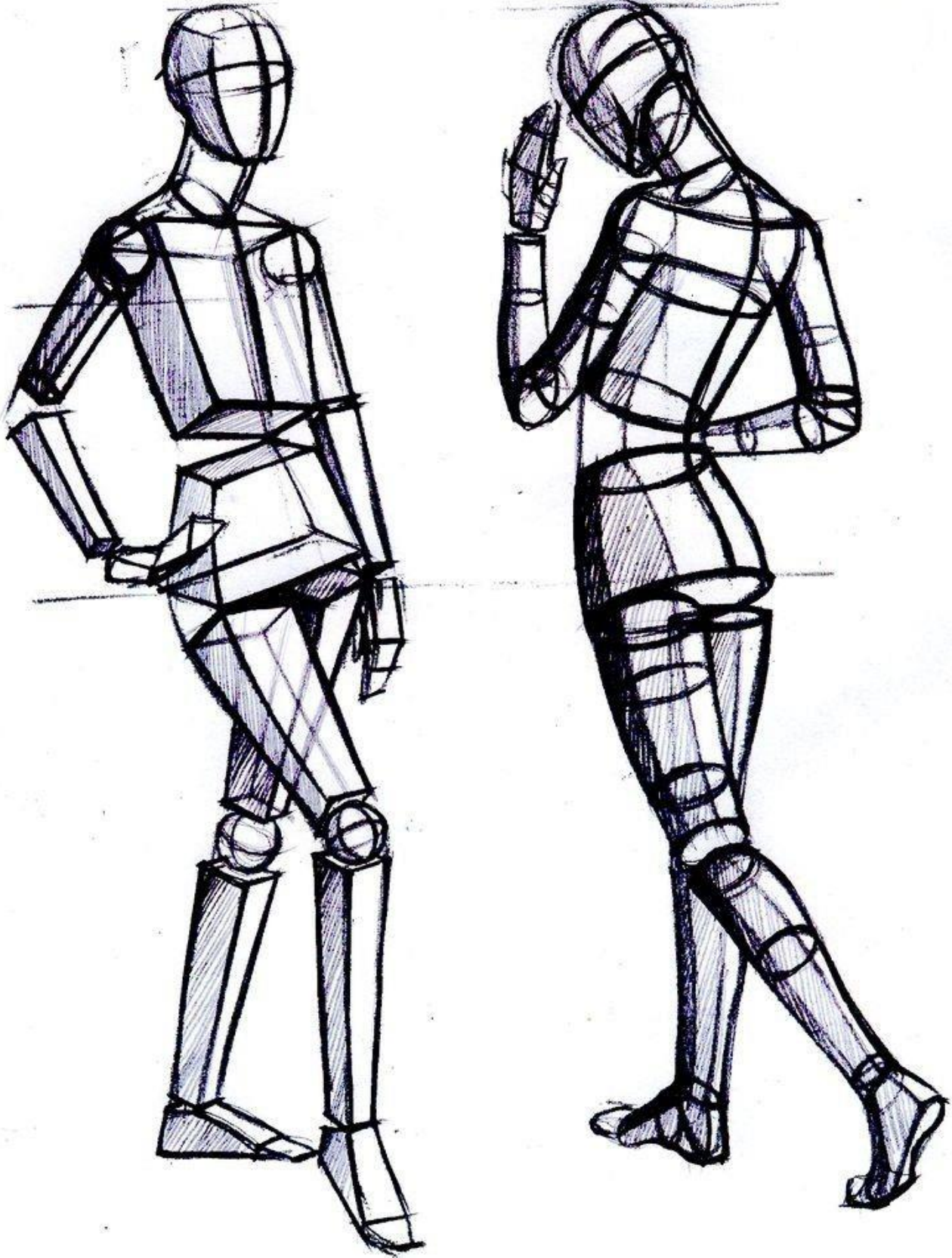

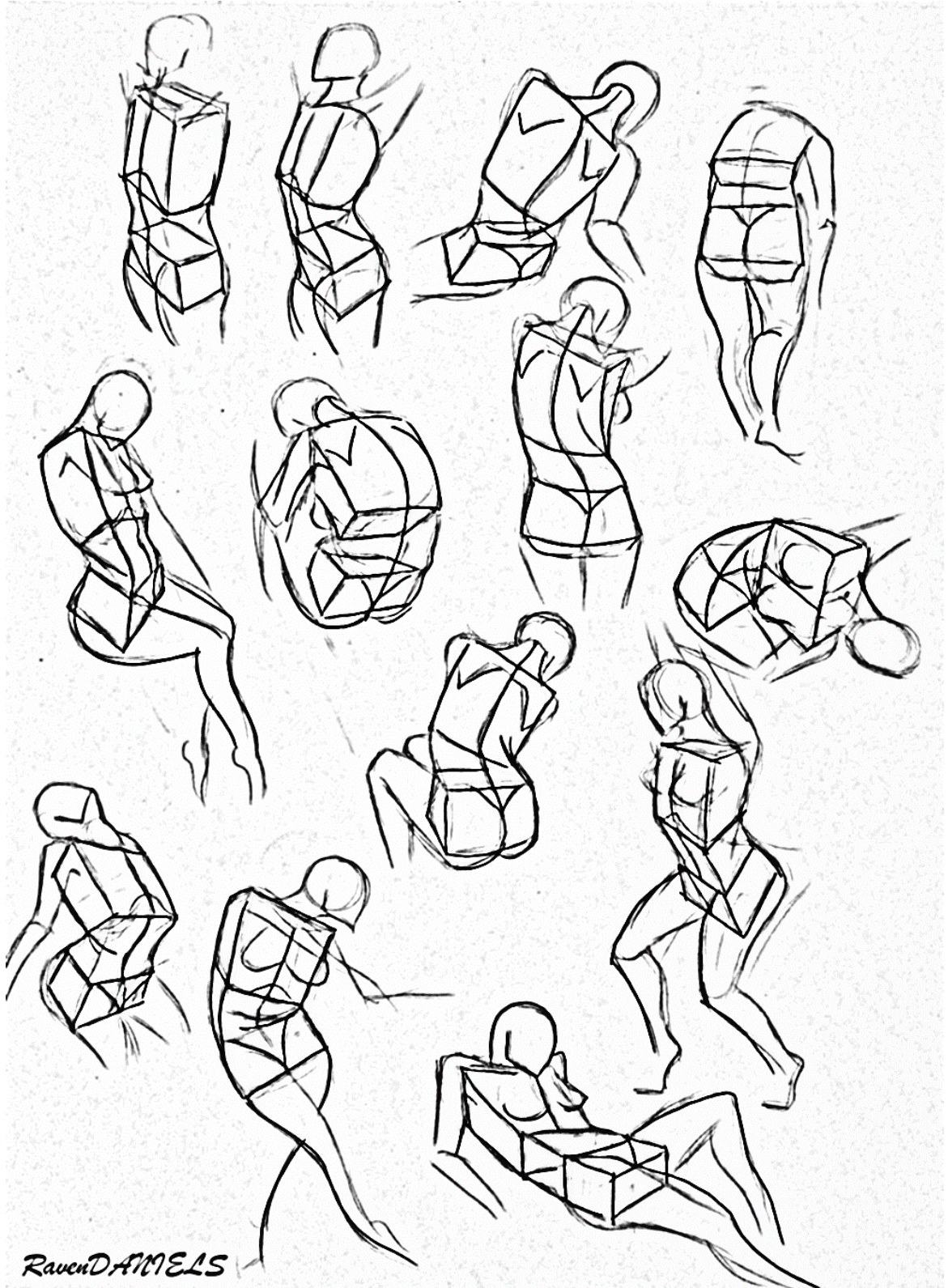

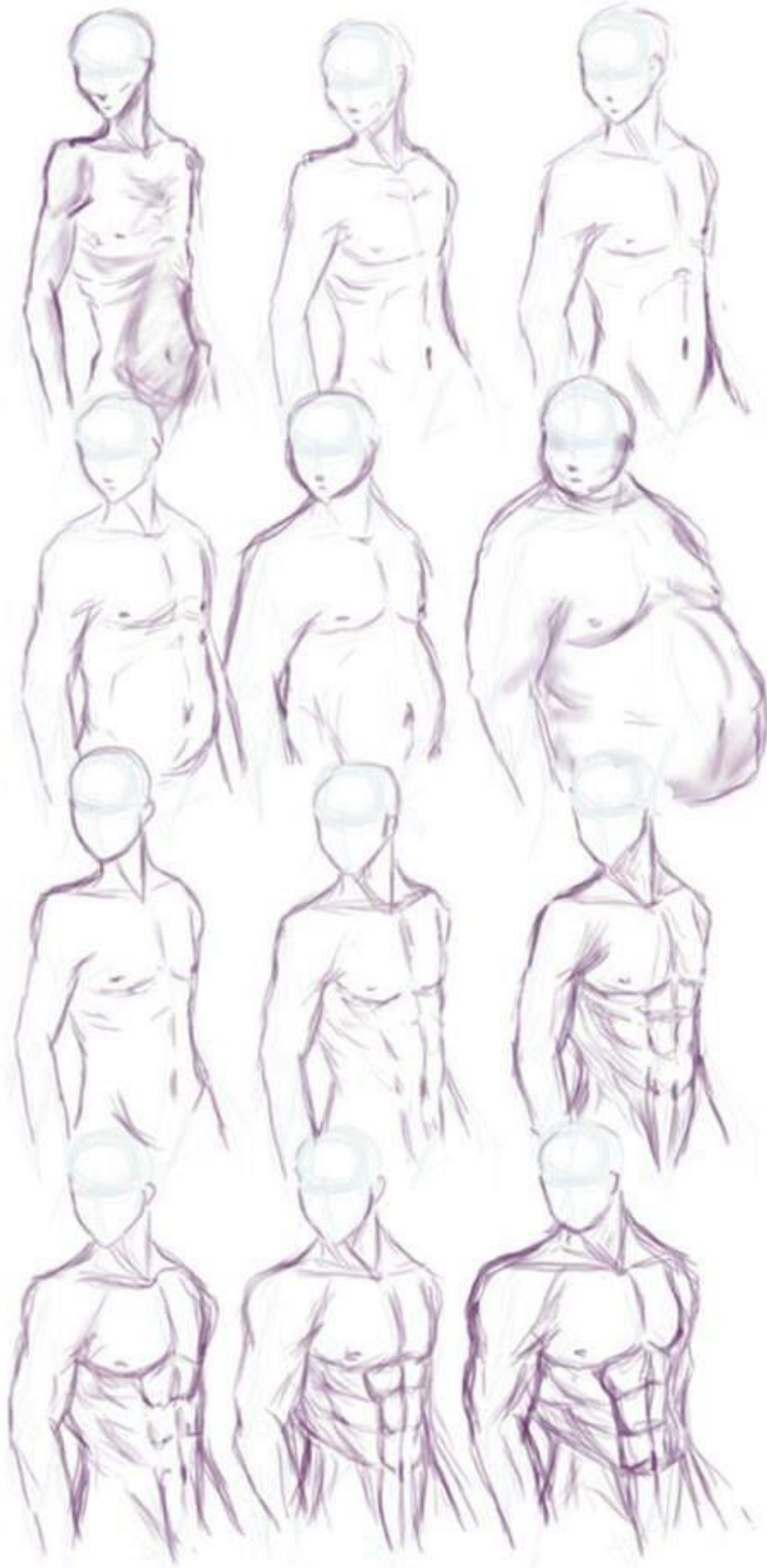

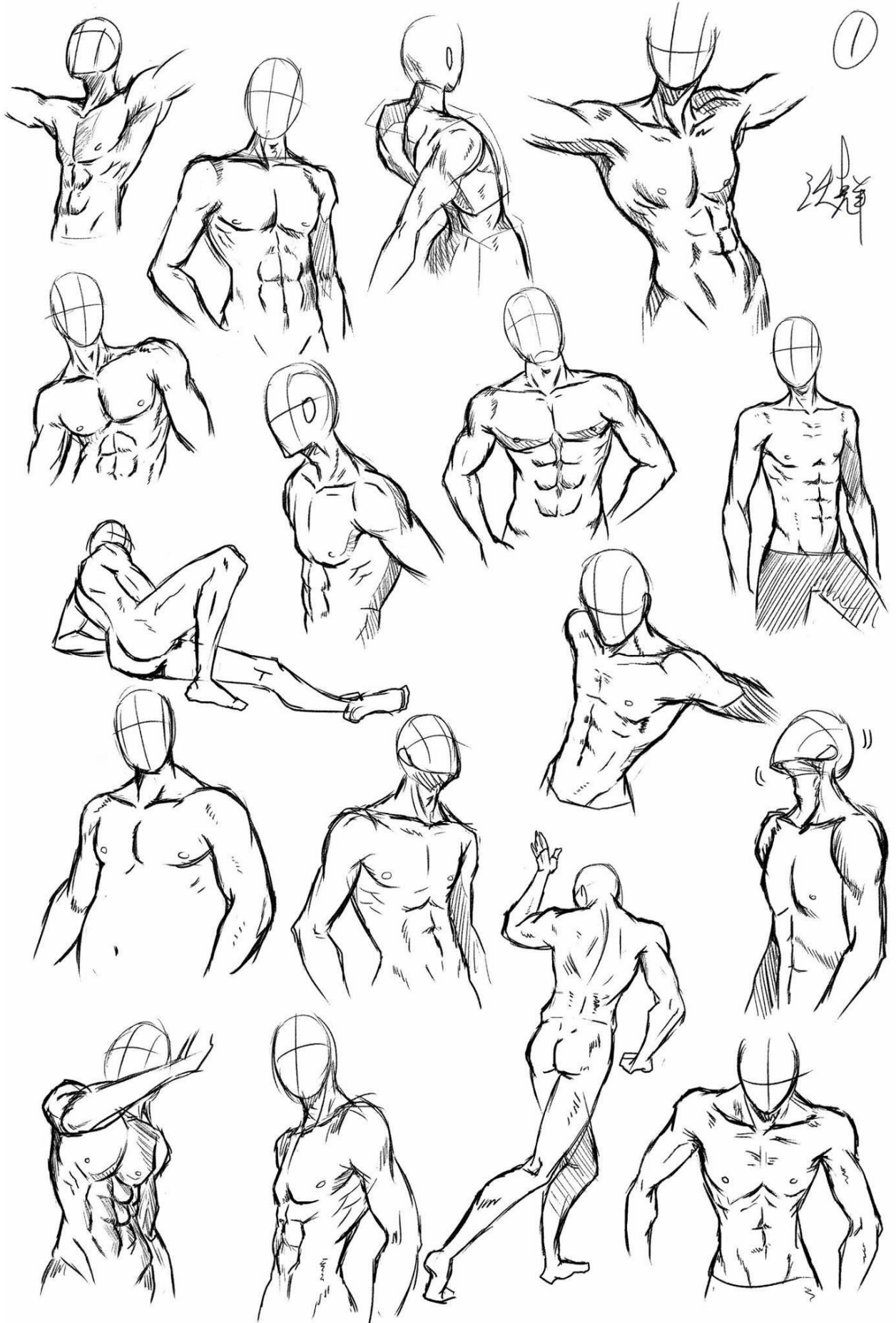



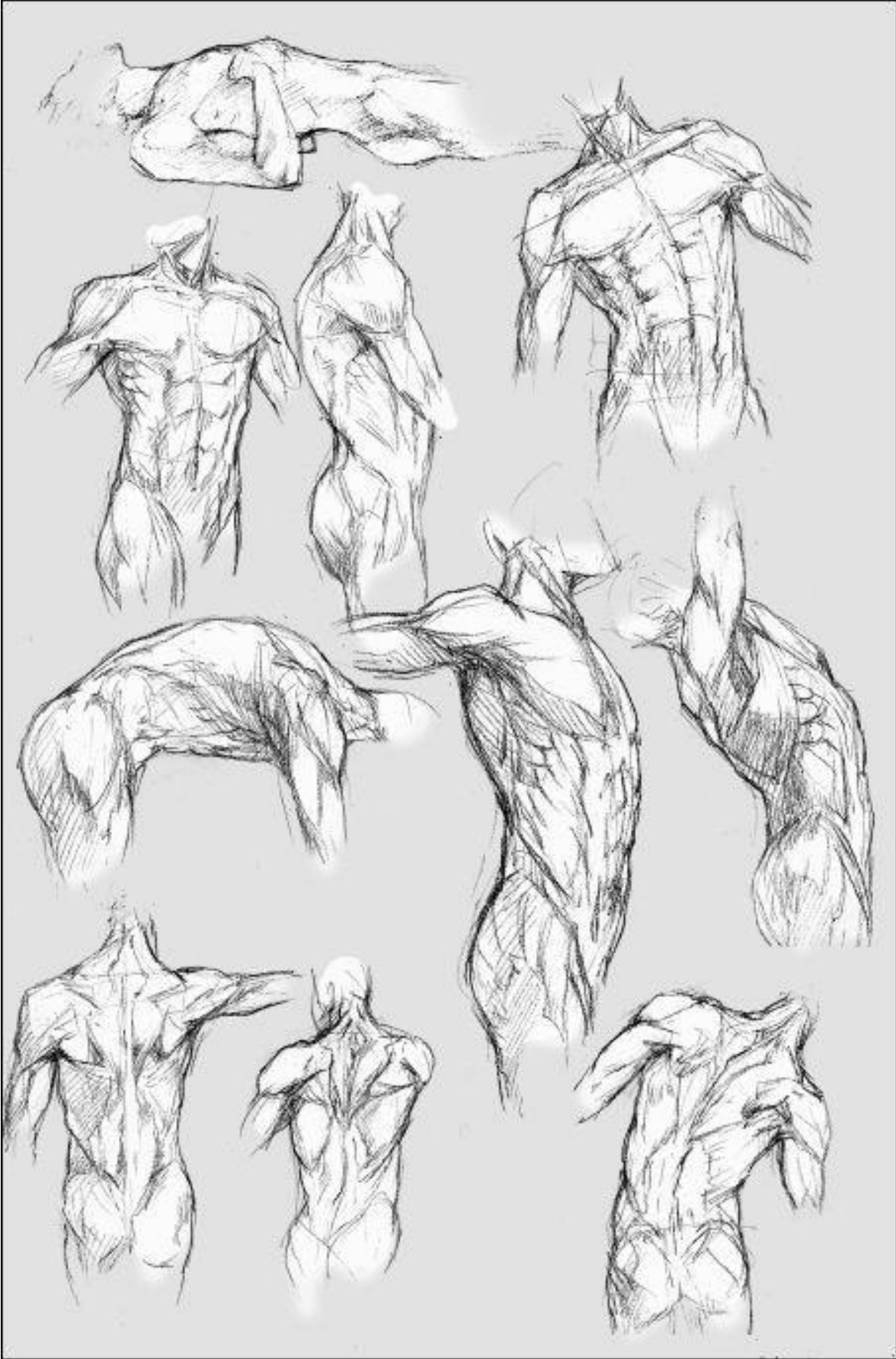

❖ El ve Kol Çizimleri

Bu kitaptaki tüm görseller internet ortamında paylaşılan ve başka sanatçıların yapmış olduğu çizimlerdir.

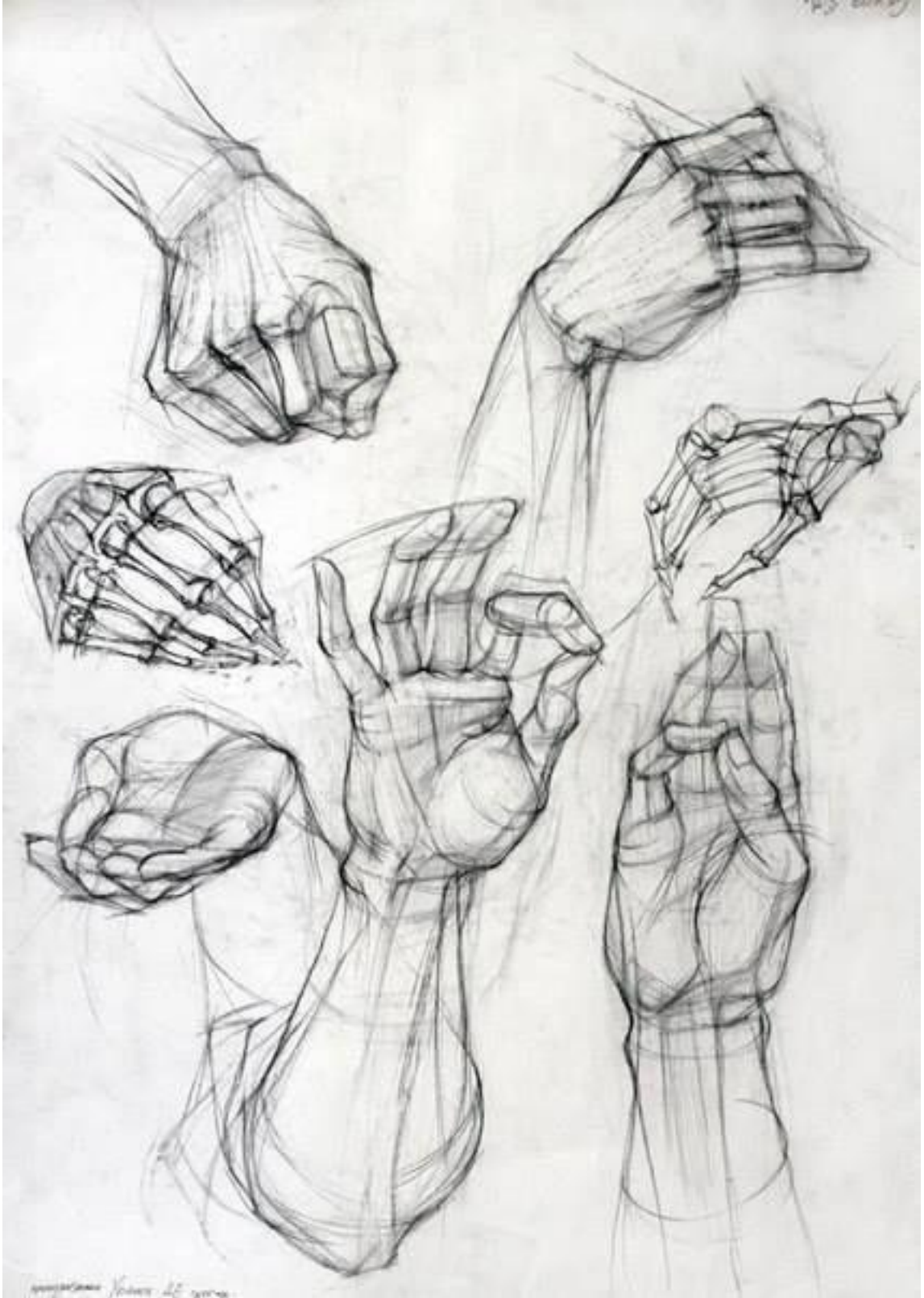

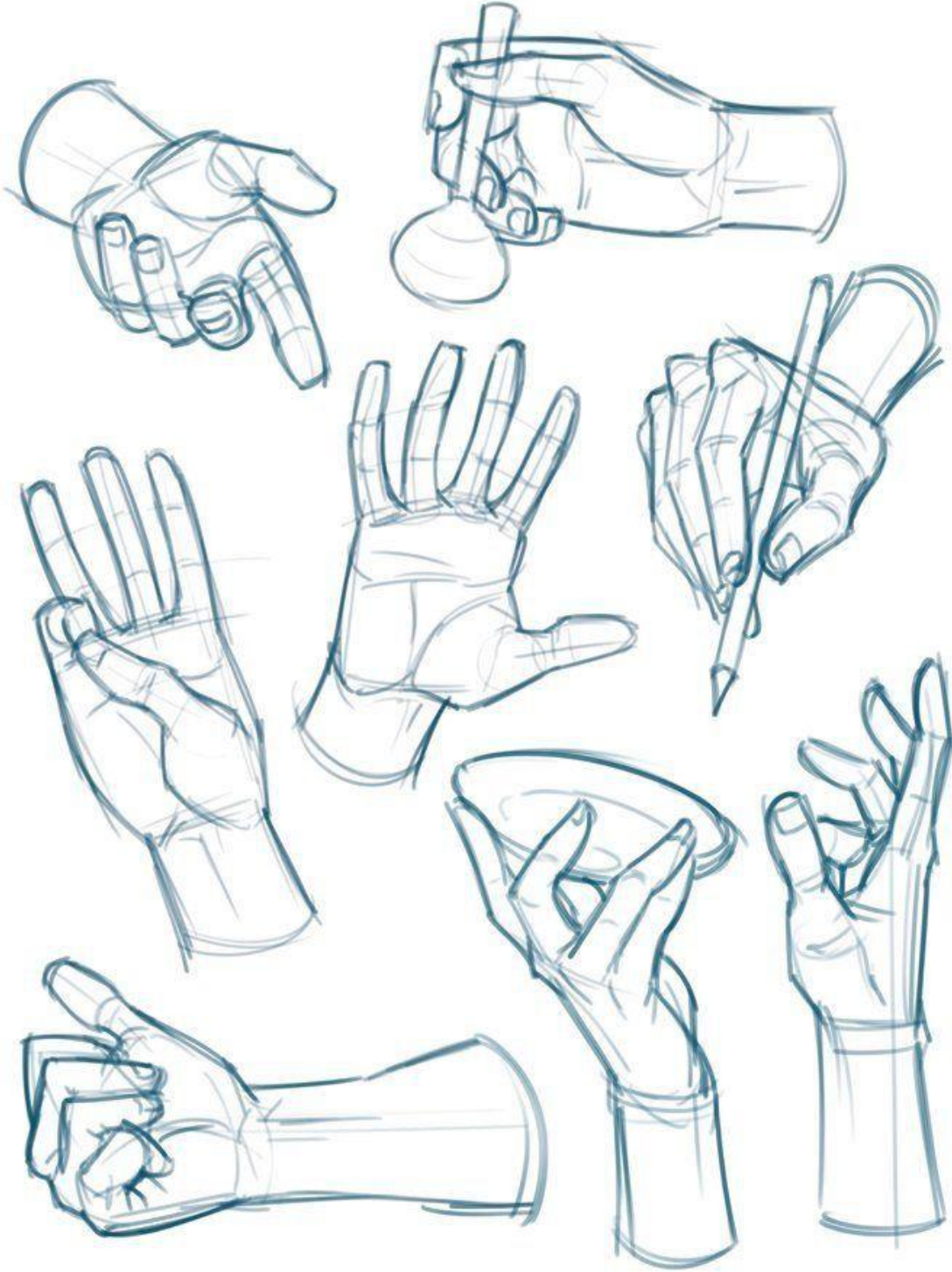

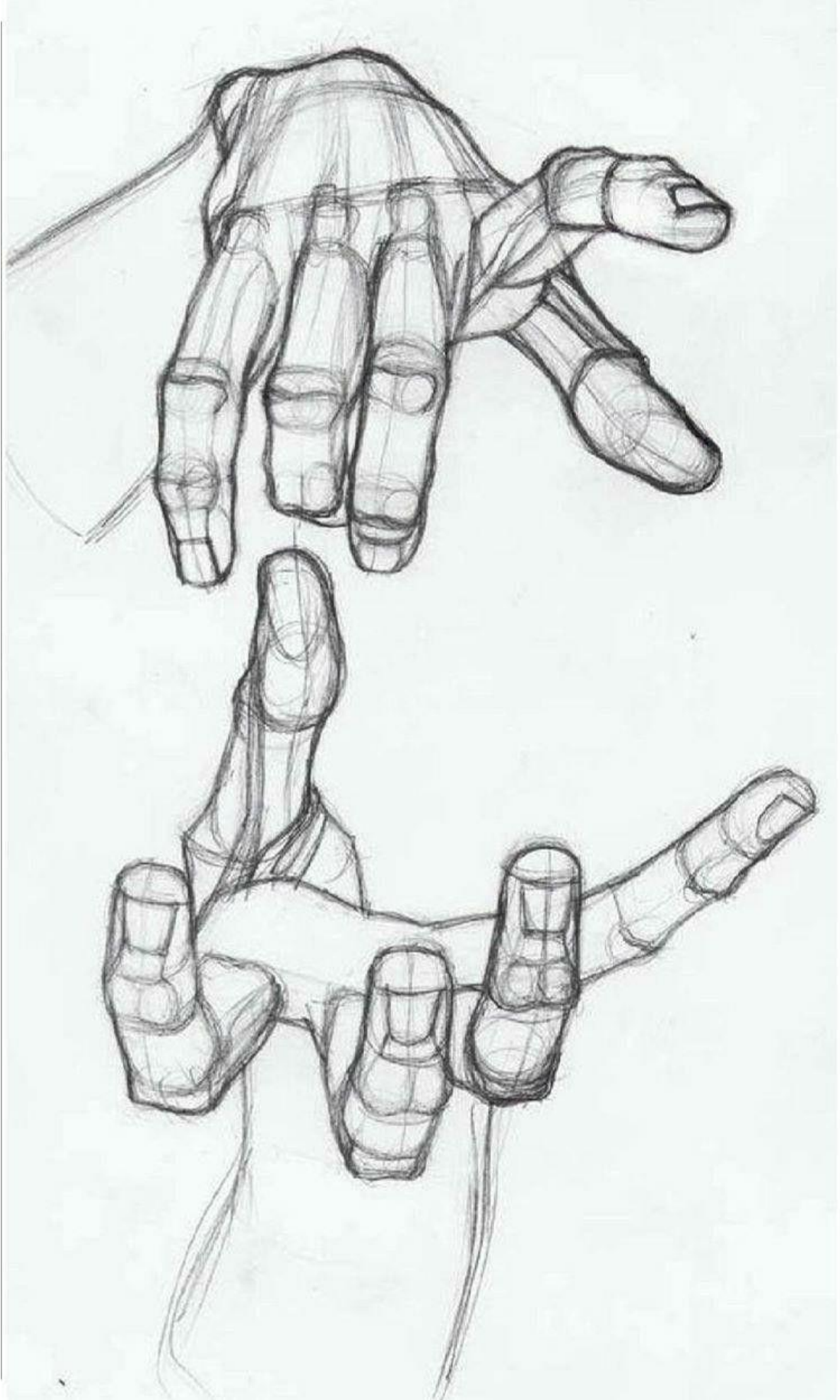



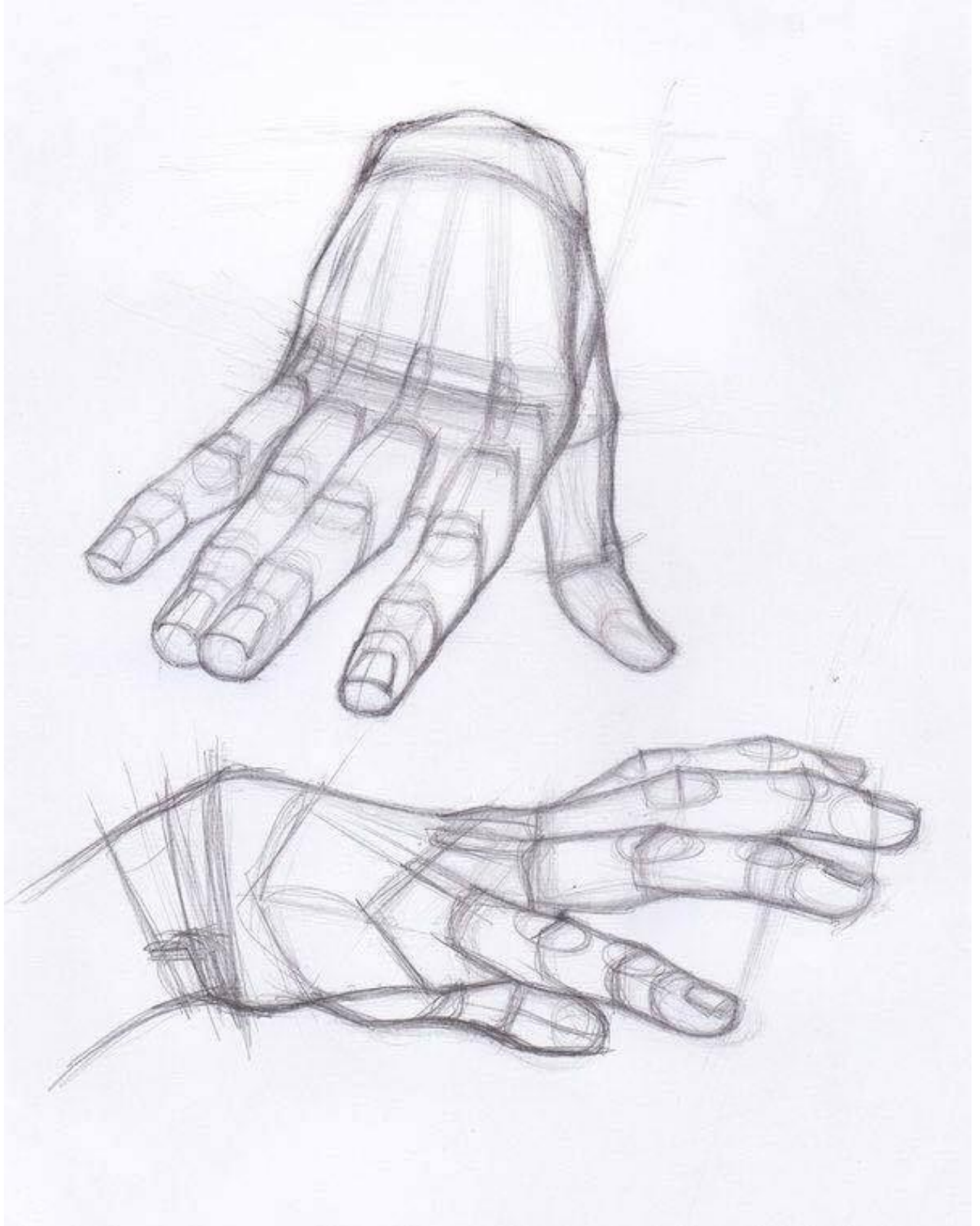



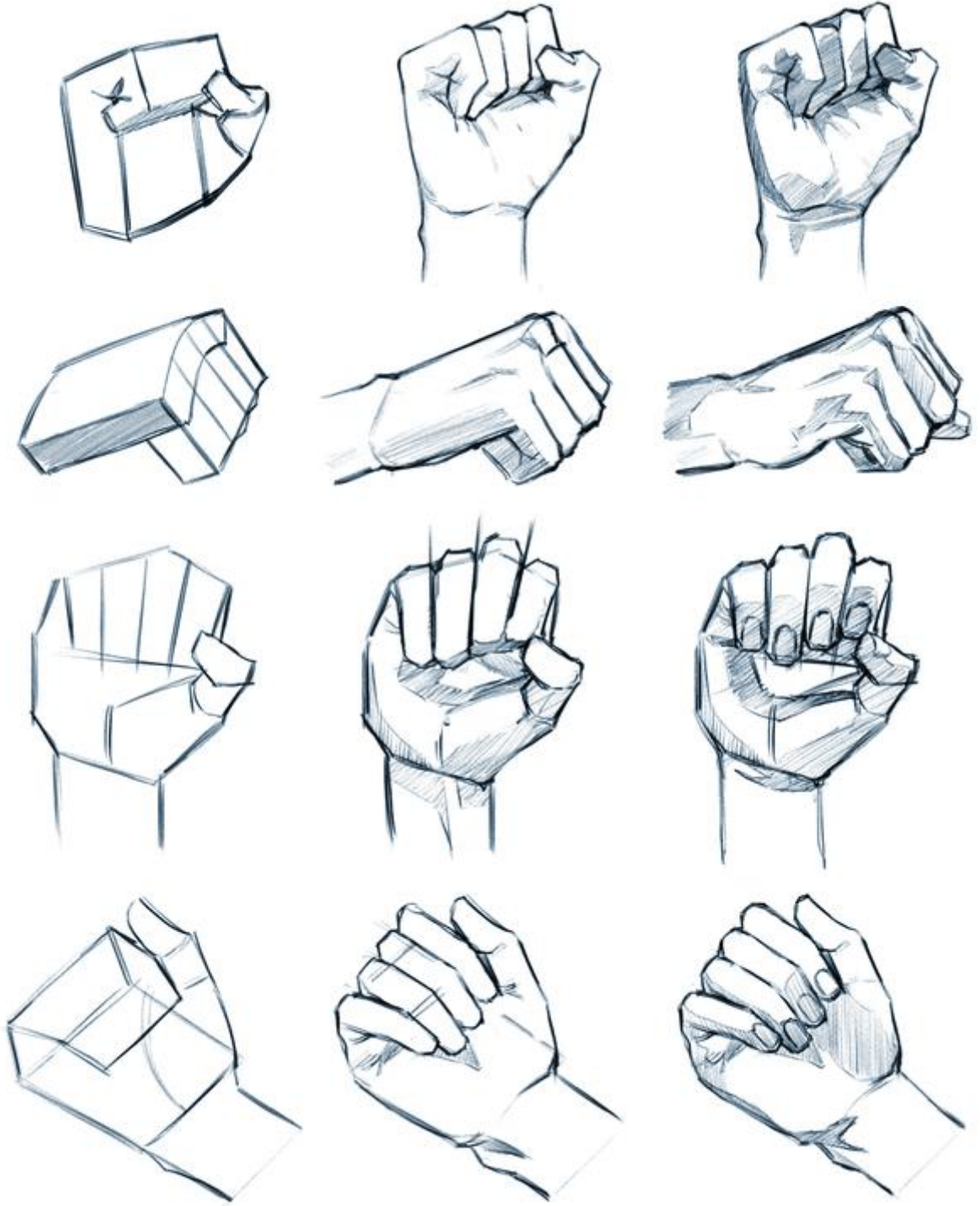



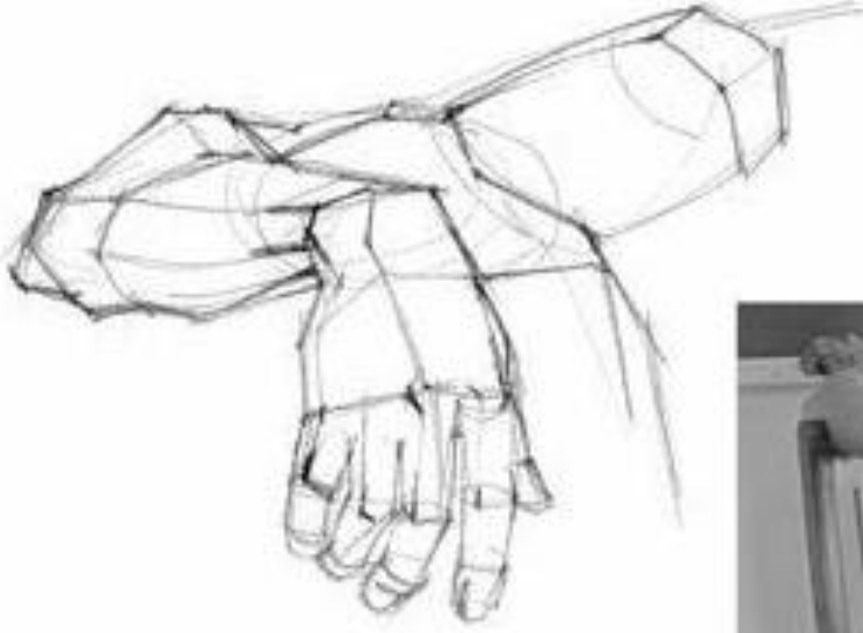





❖ Ayak ve Bacak Çizimleri

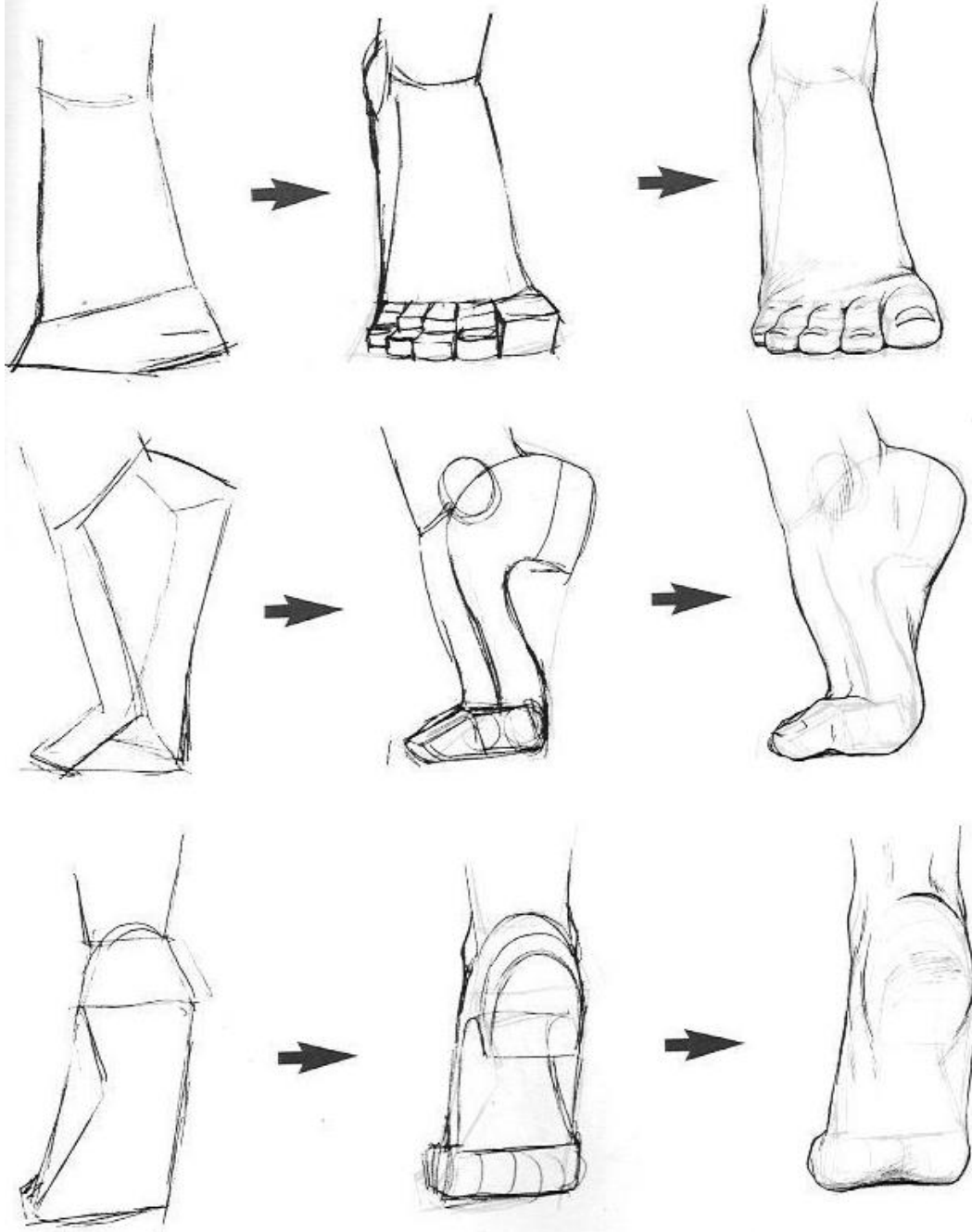





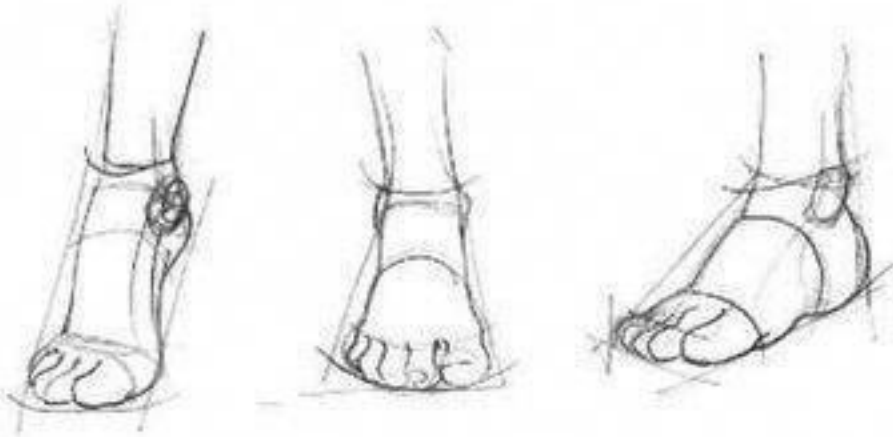
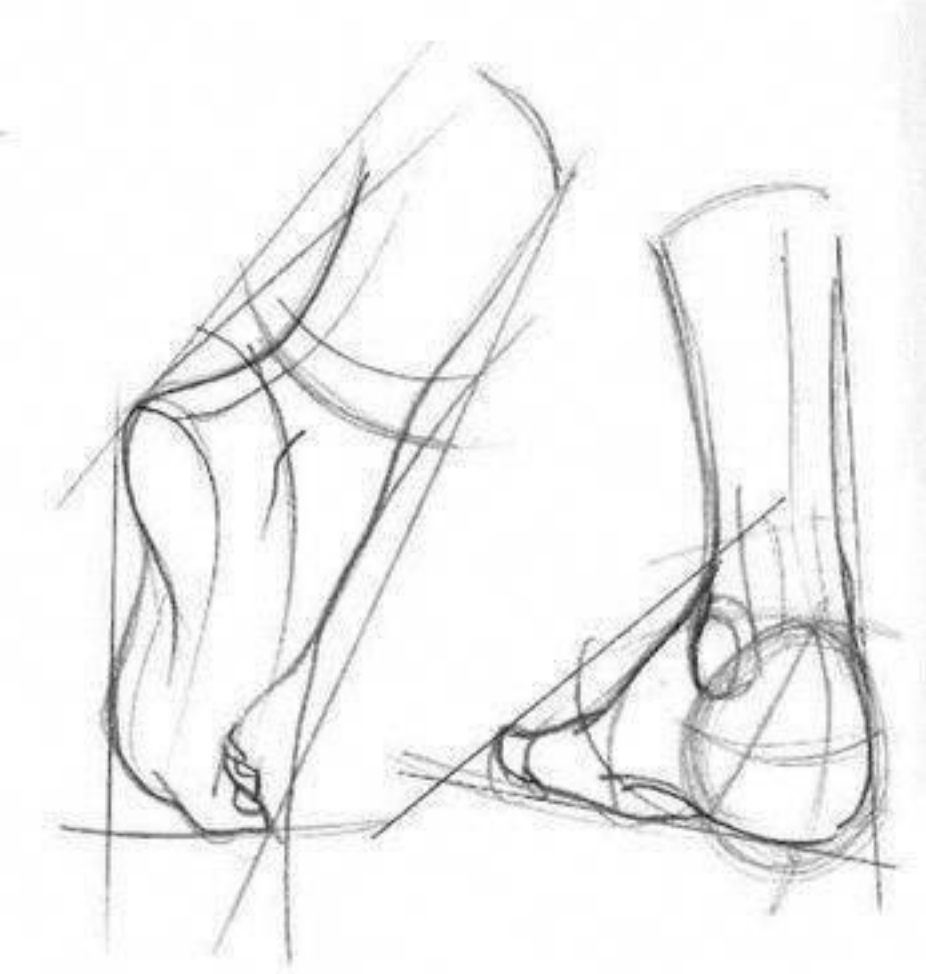

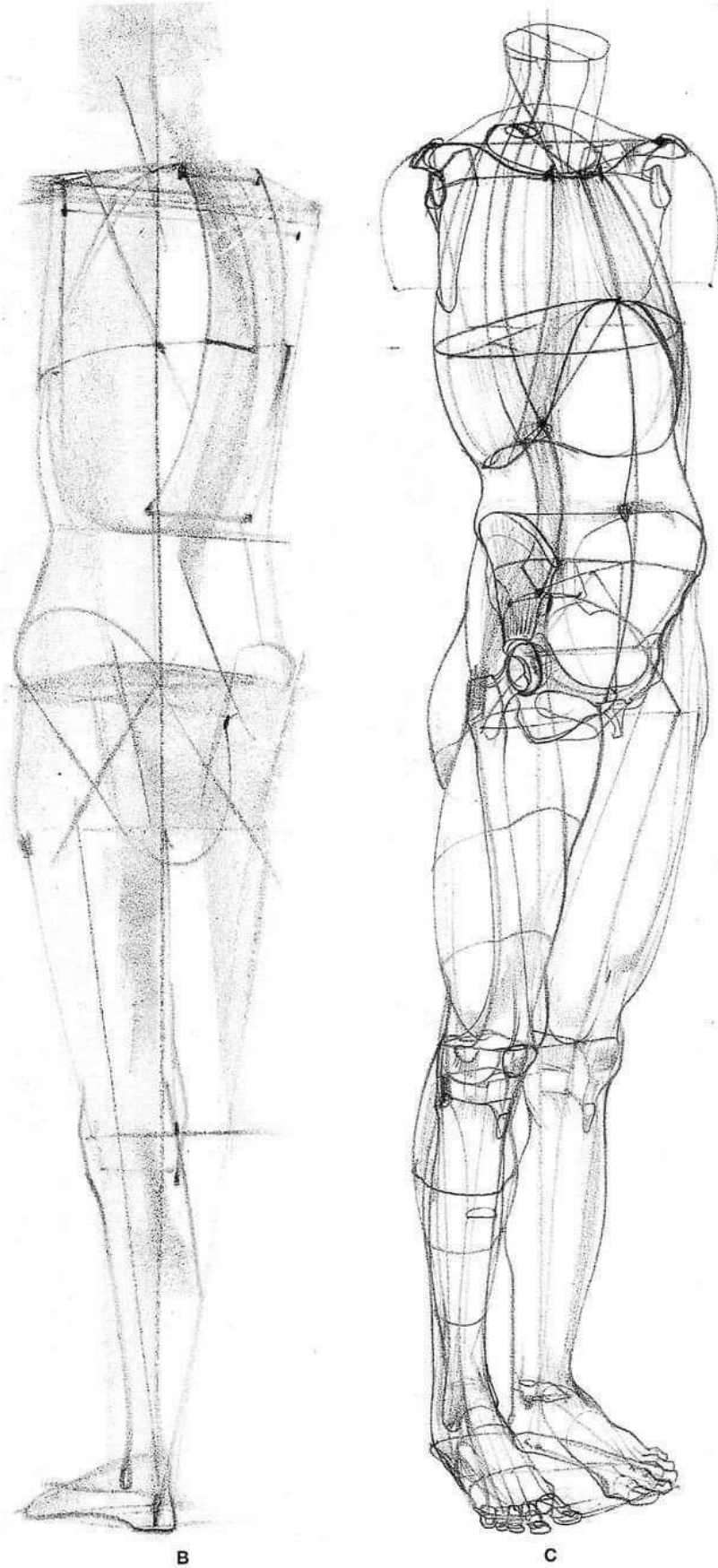



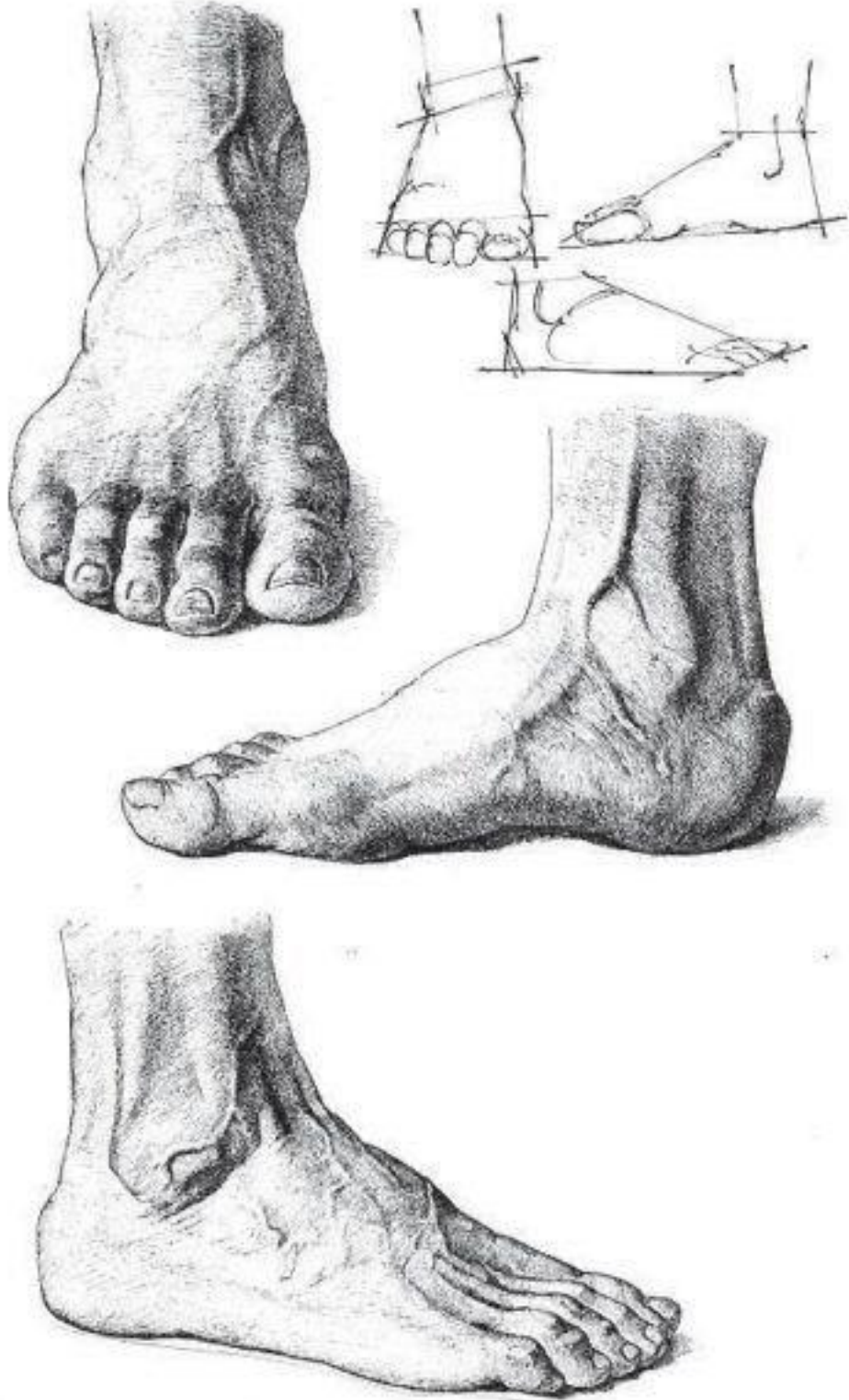



❖ Örnek İnsan Figürü Çizimleri





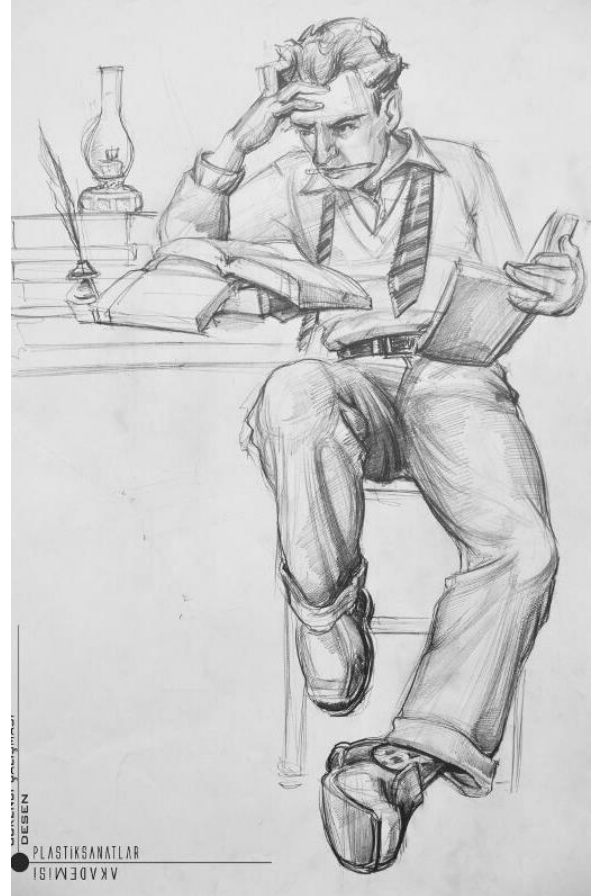

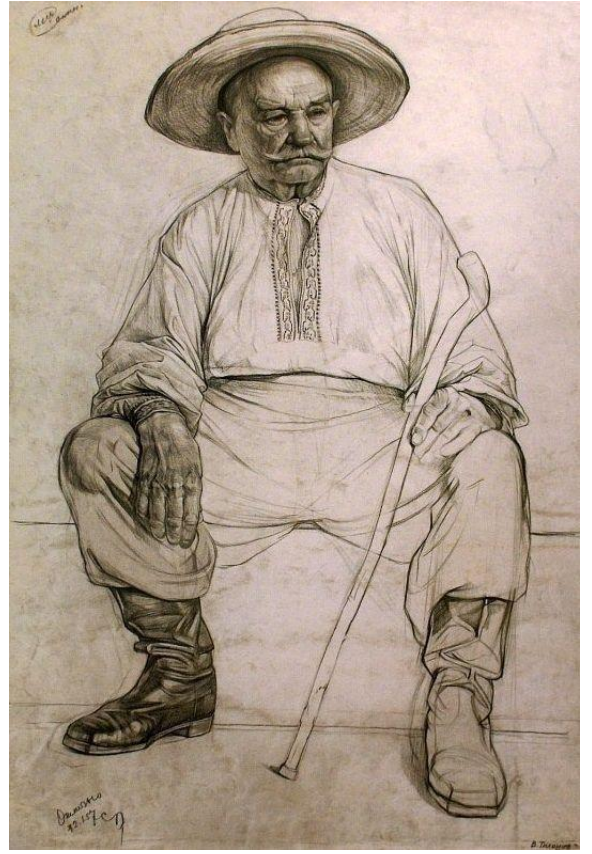
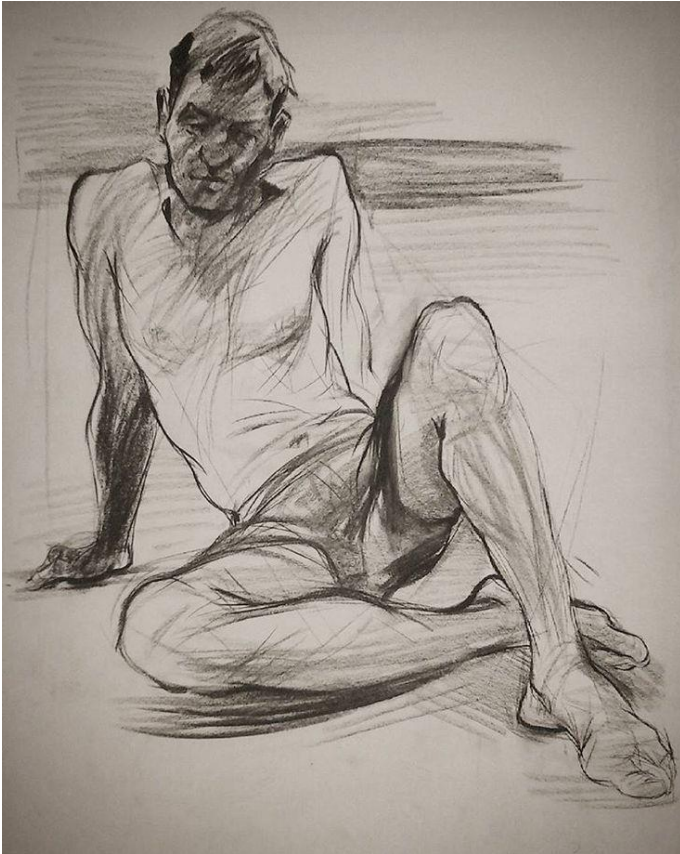
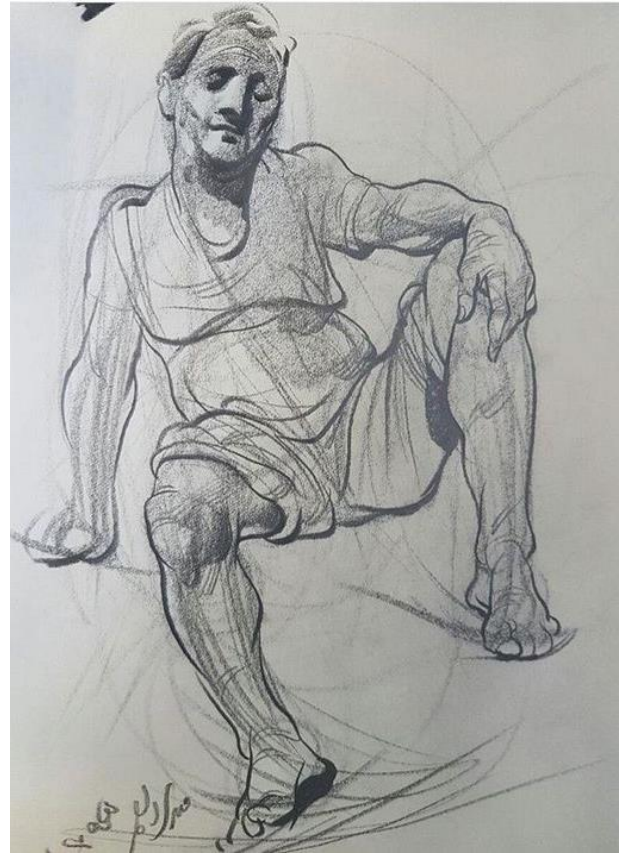



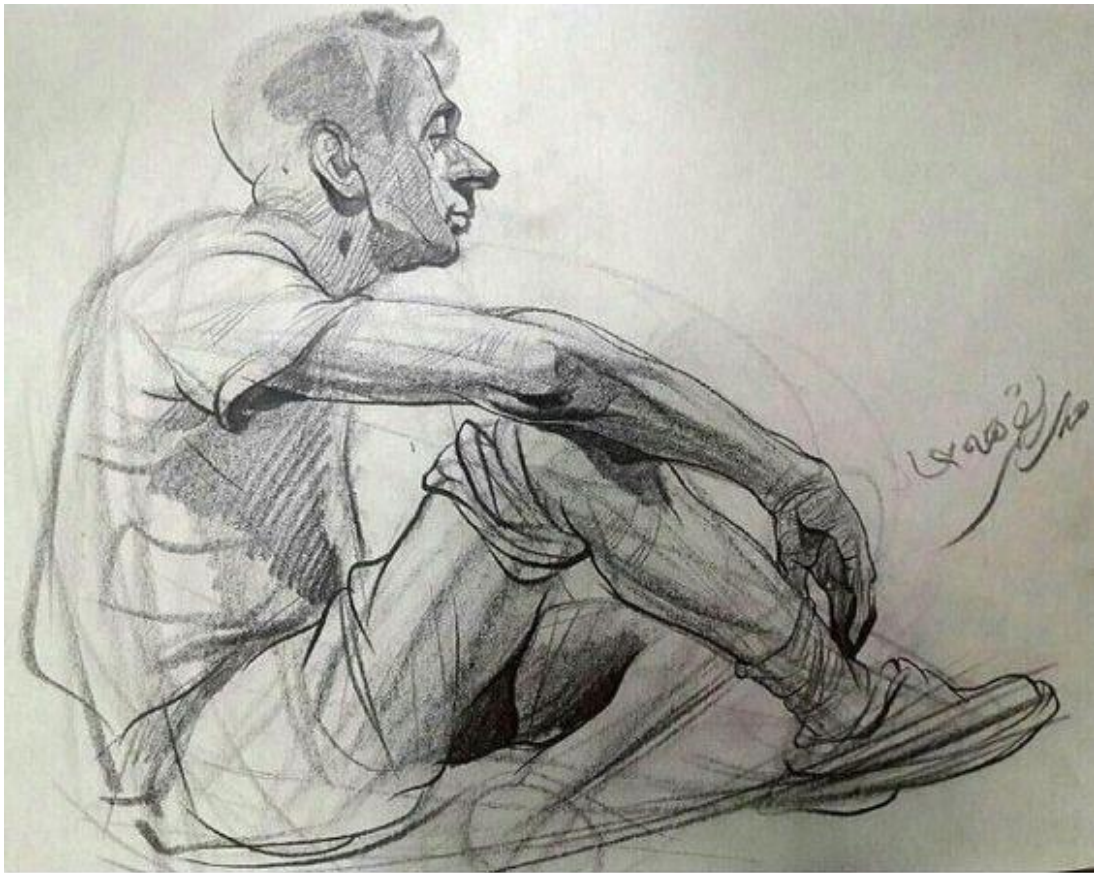
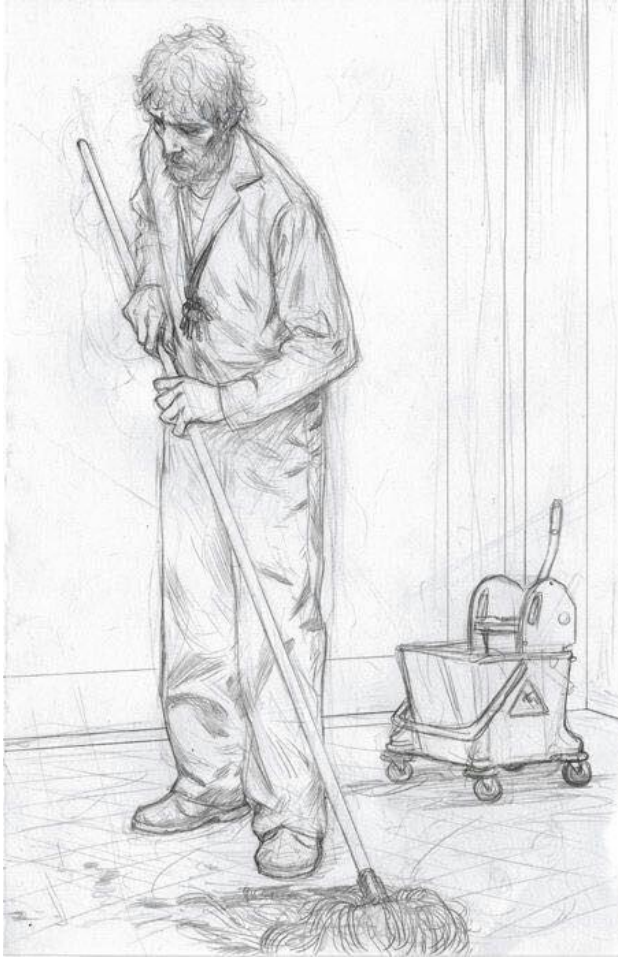





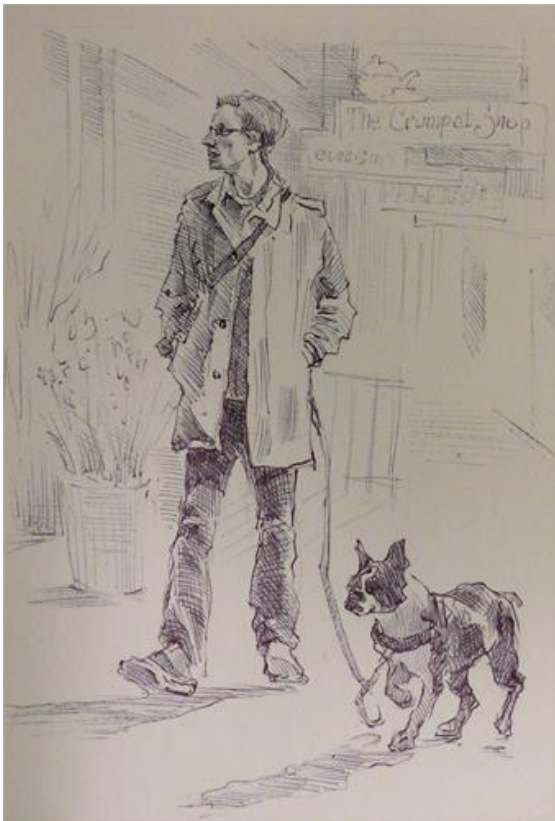
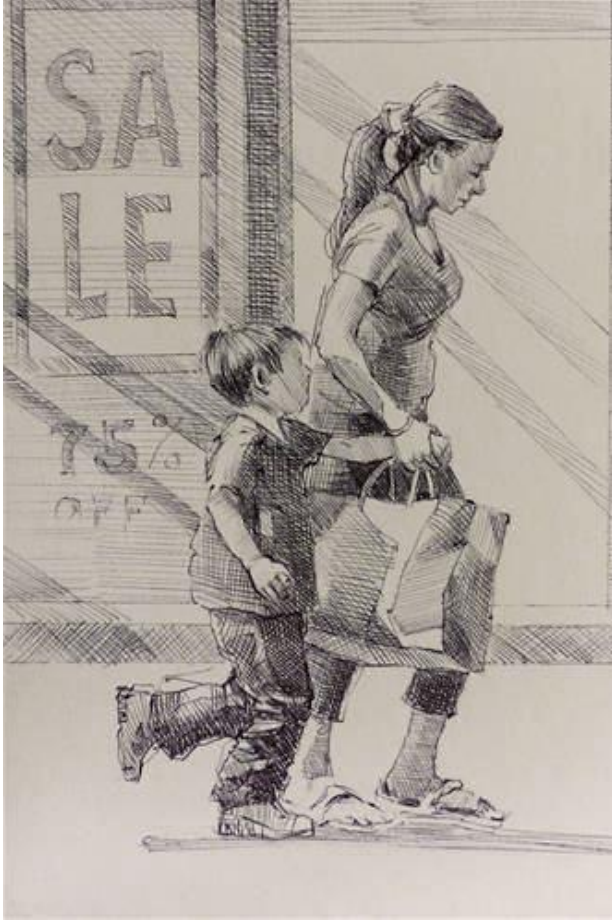

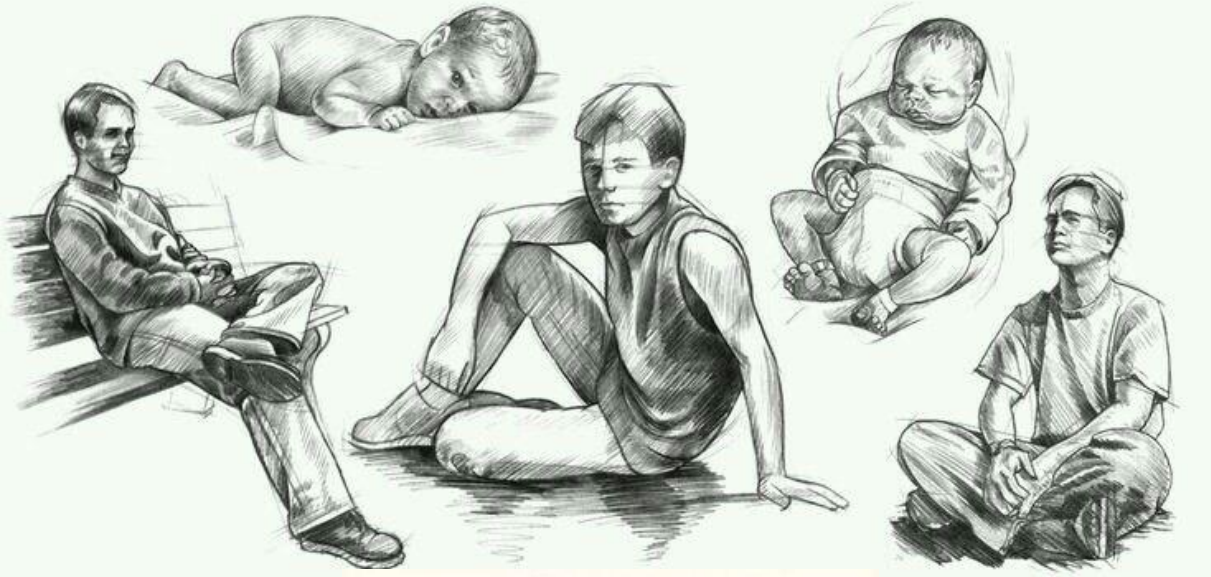

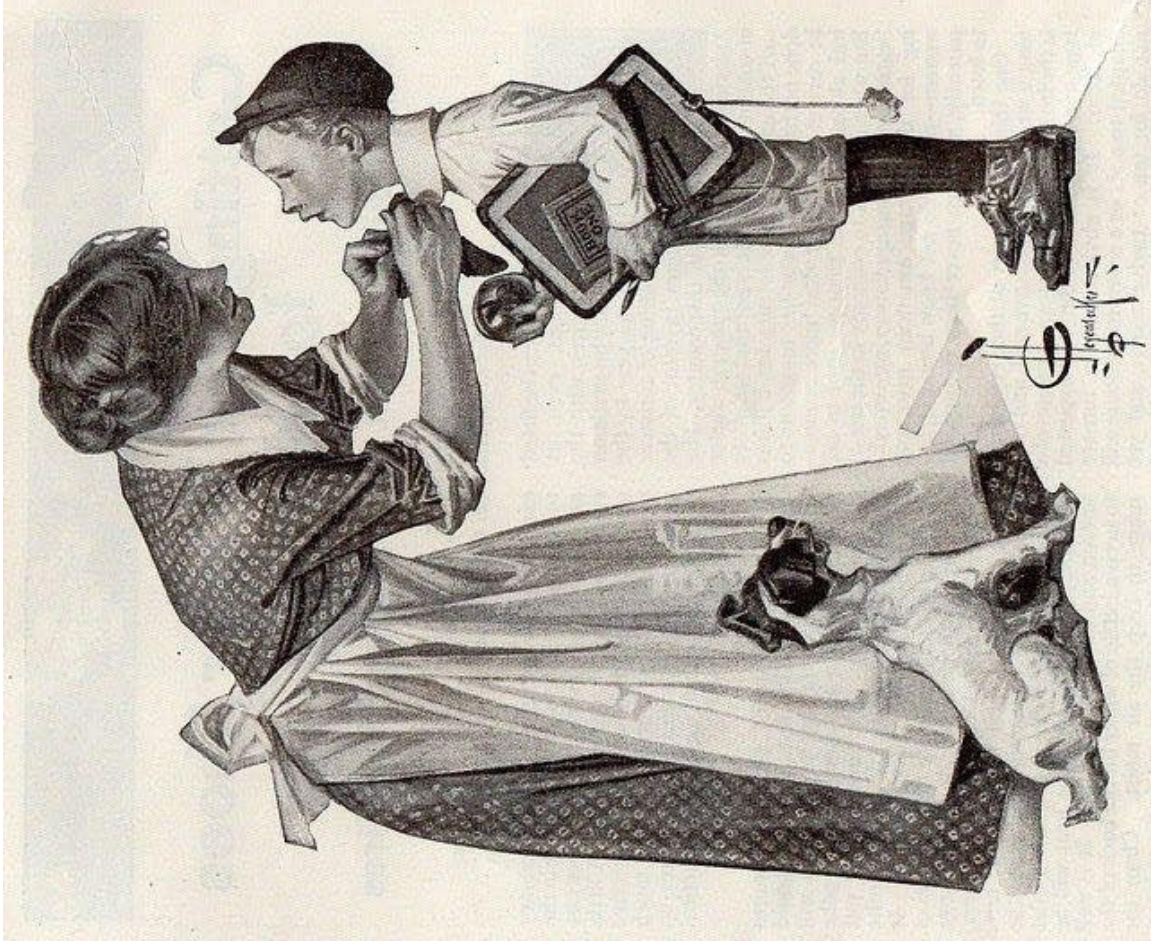

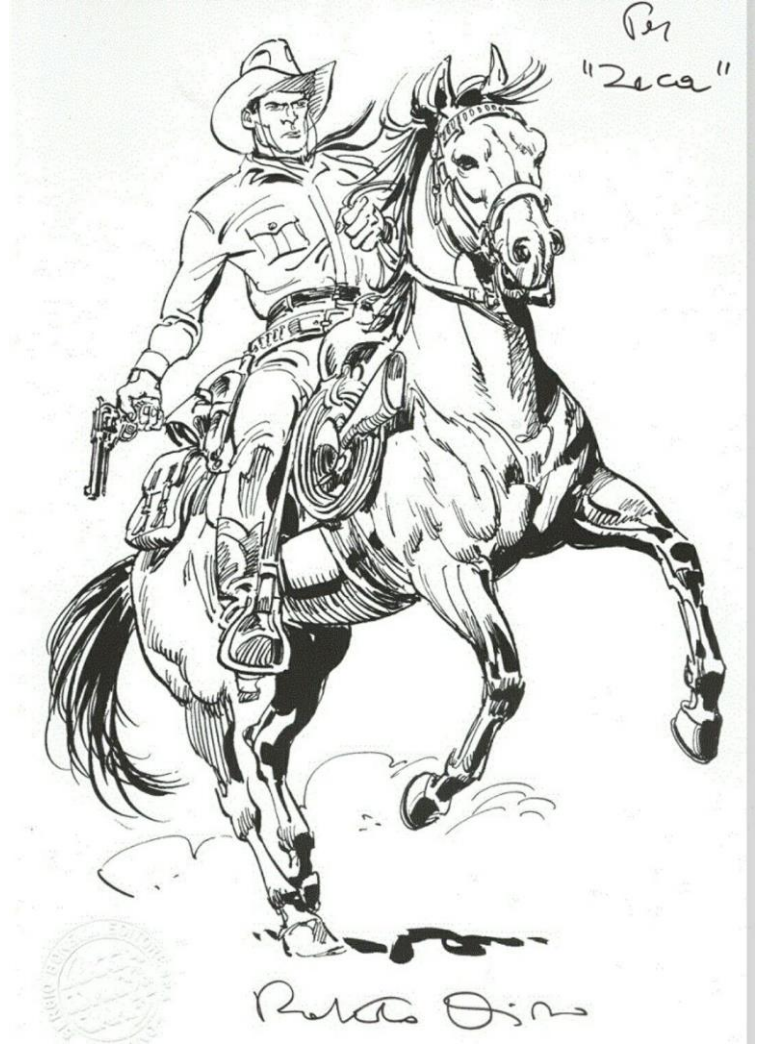







@Alyz\_梁生



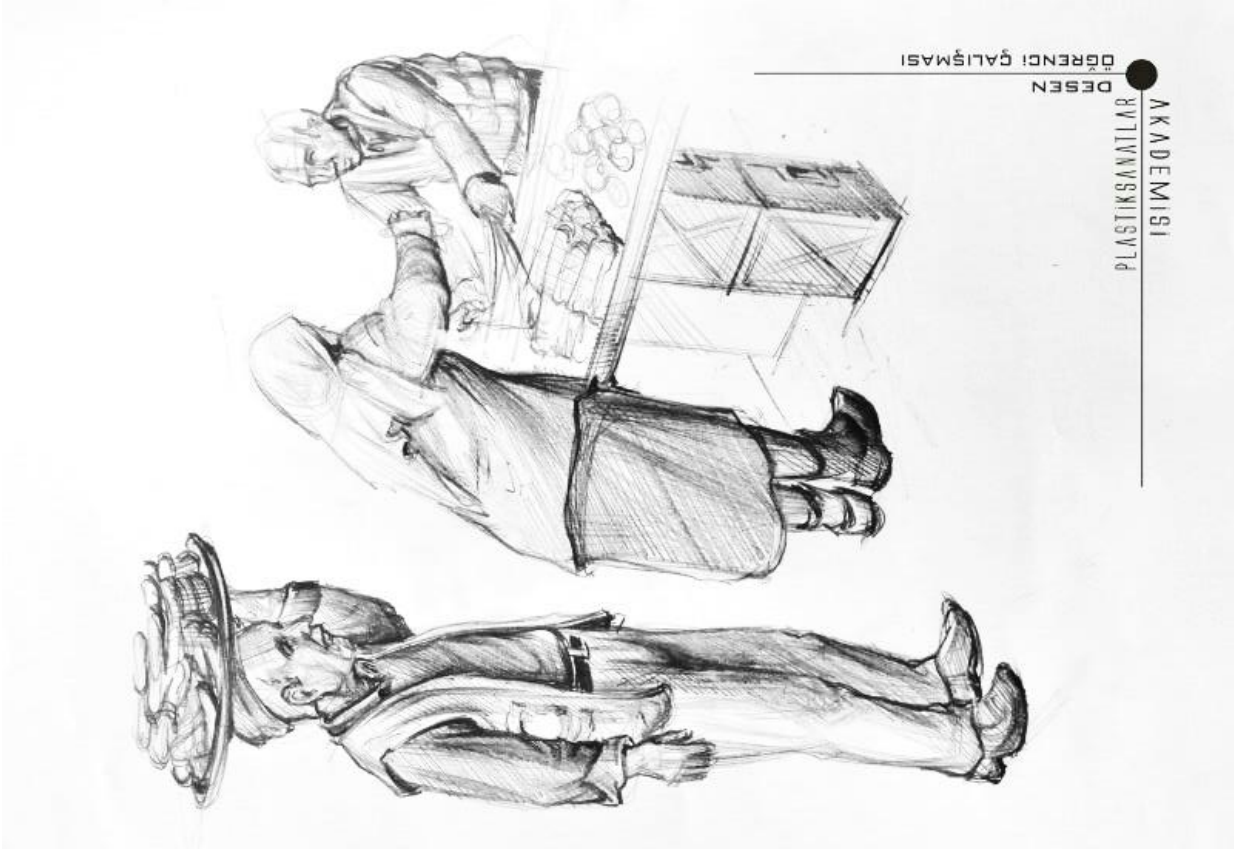



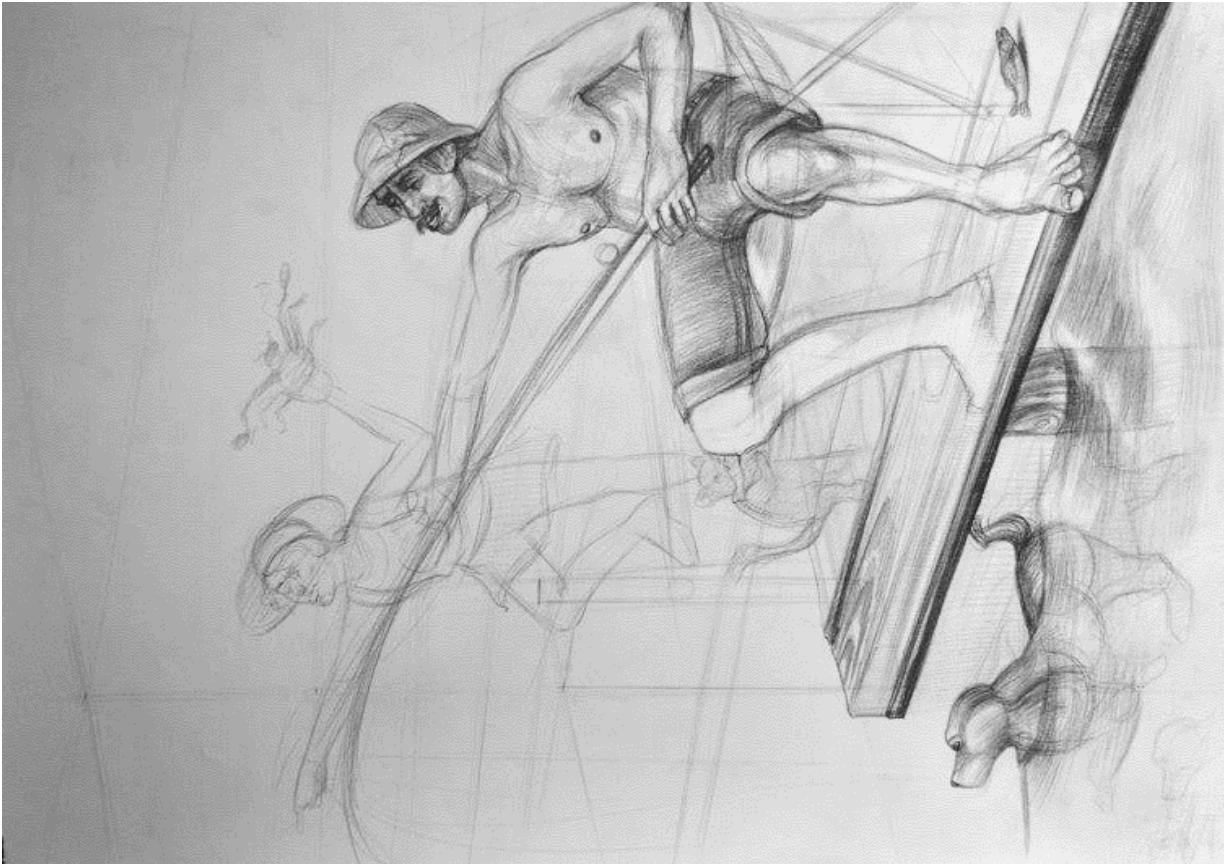
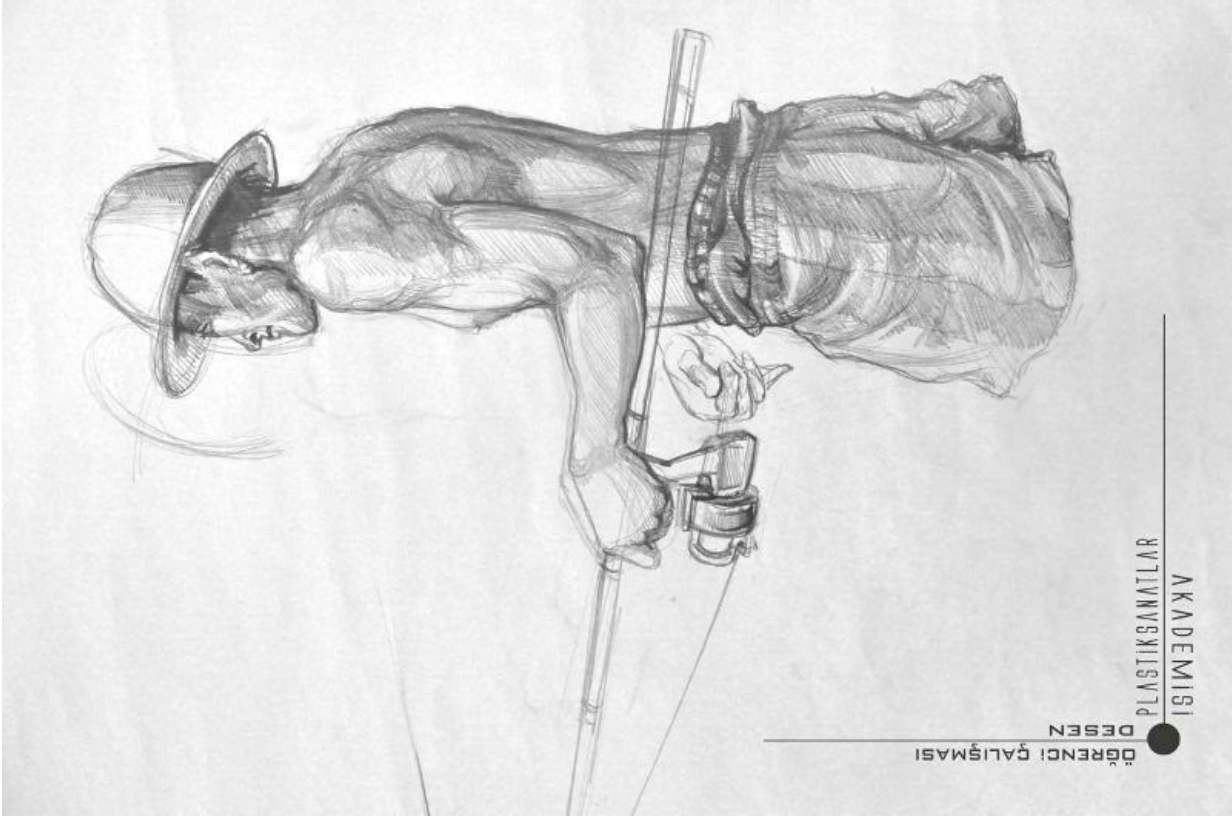



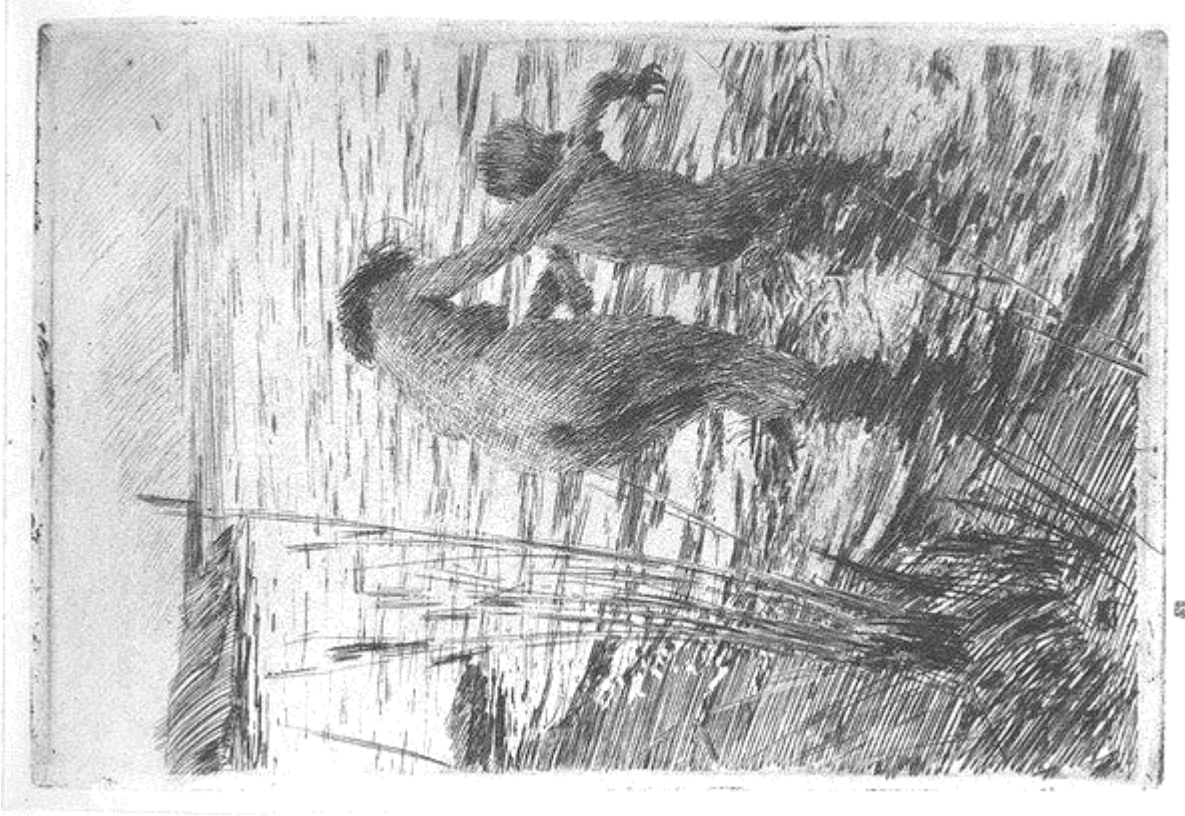

## ARAÇ VE EŞYA ÇİZİMLERİ

### A- Araçlar

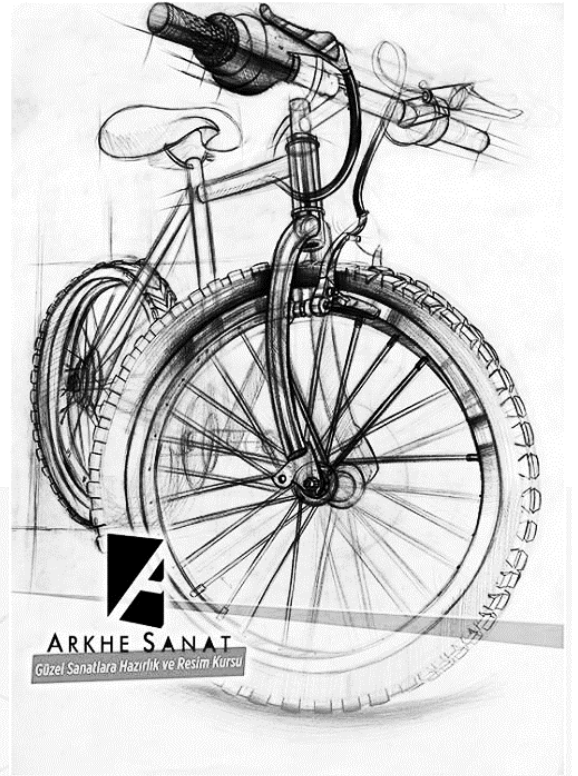
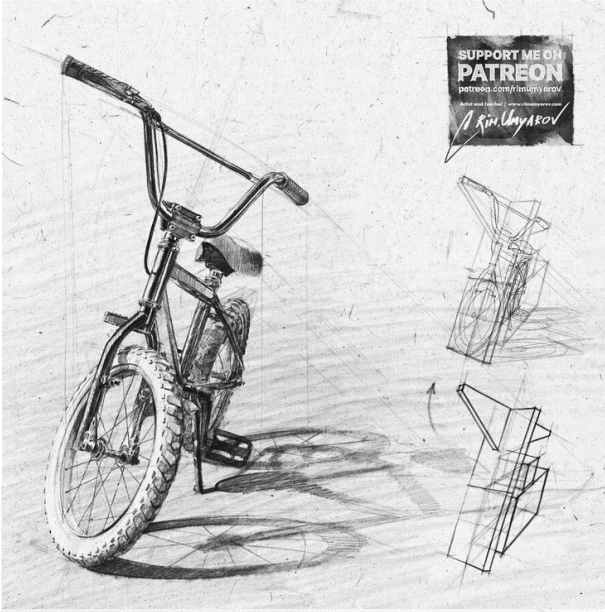

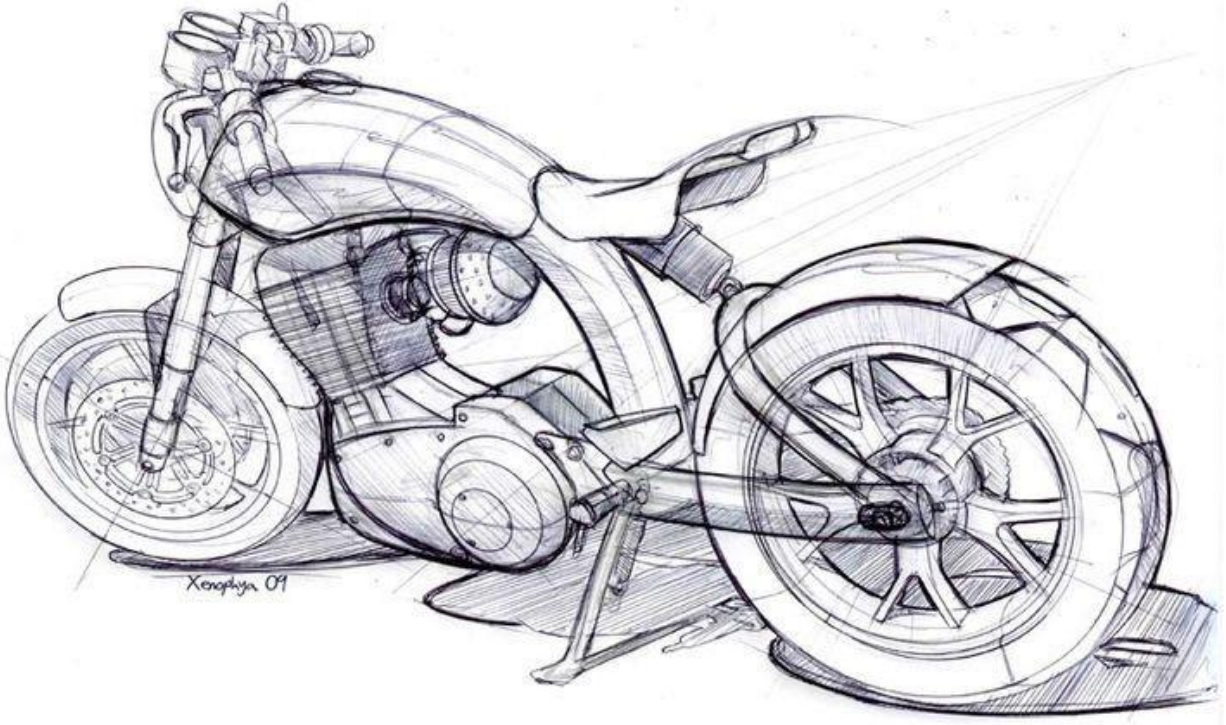





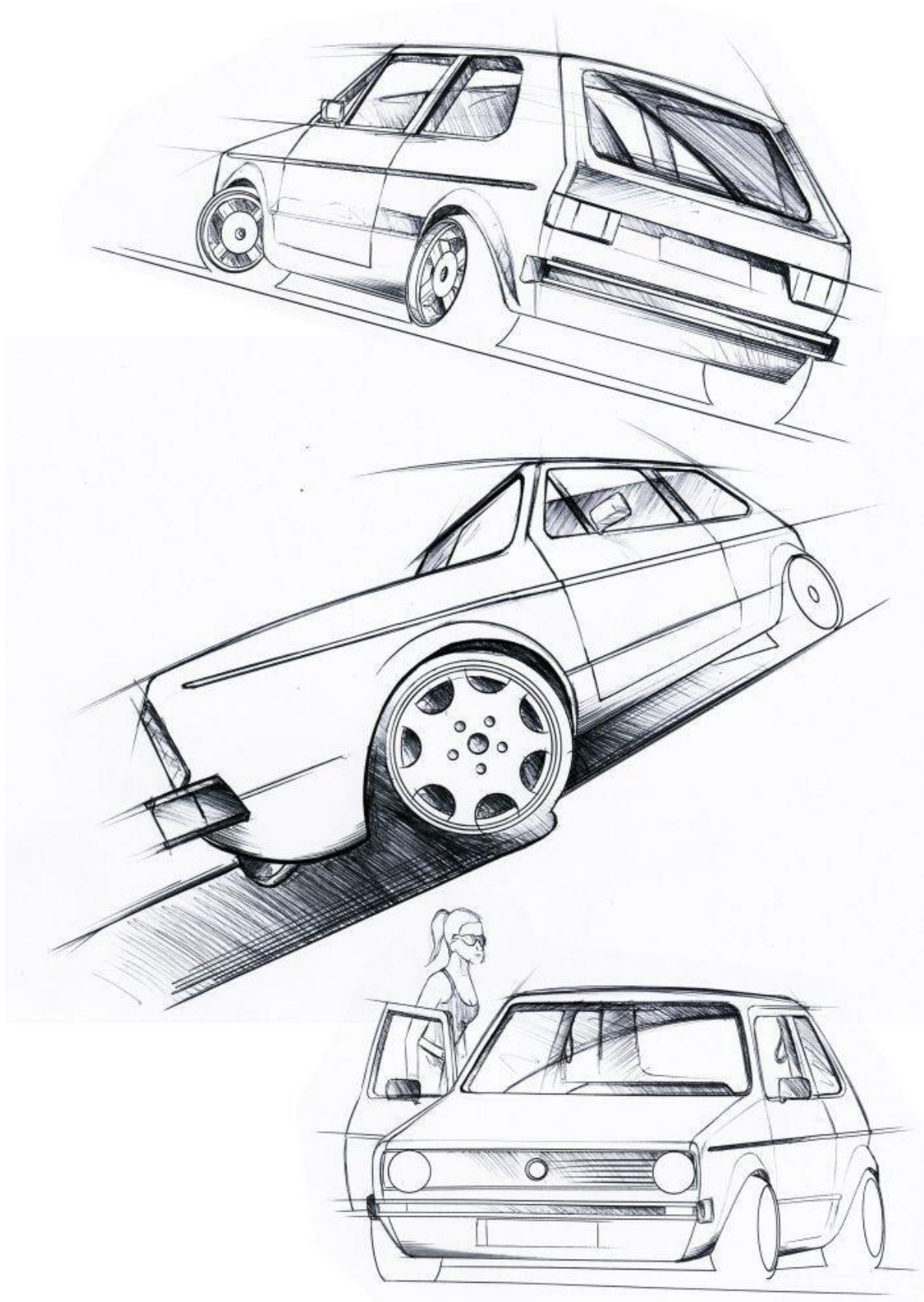

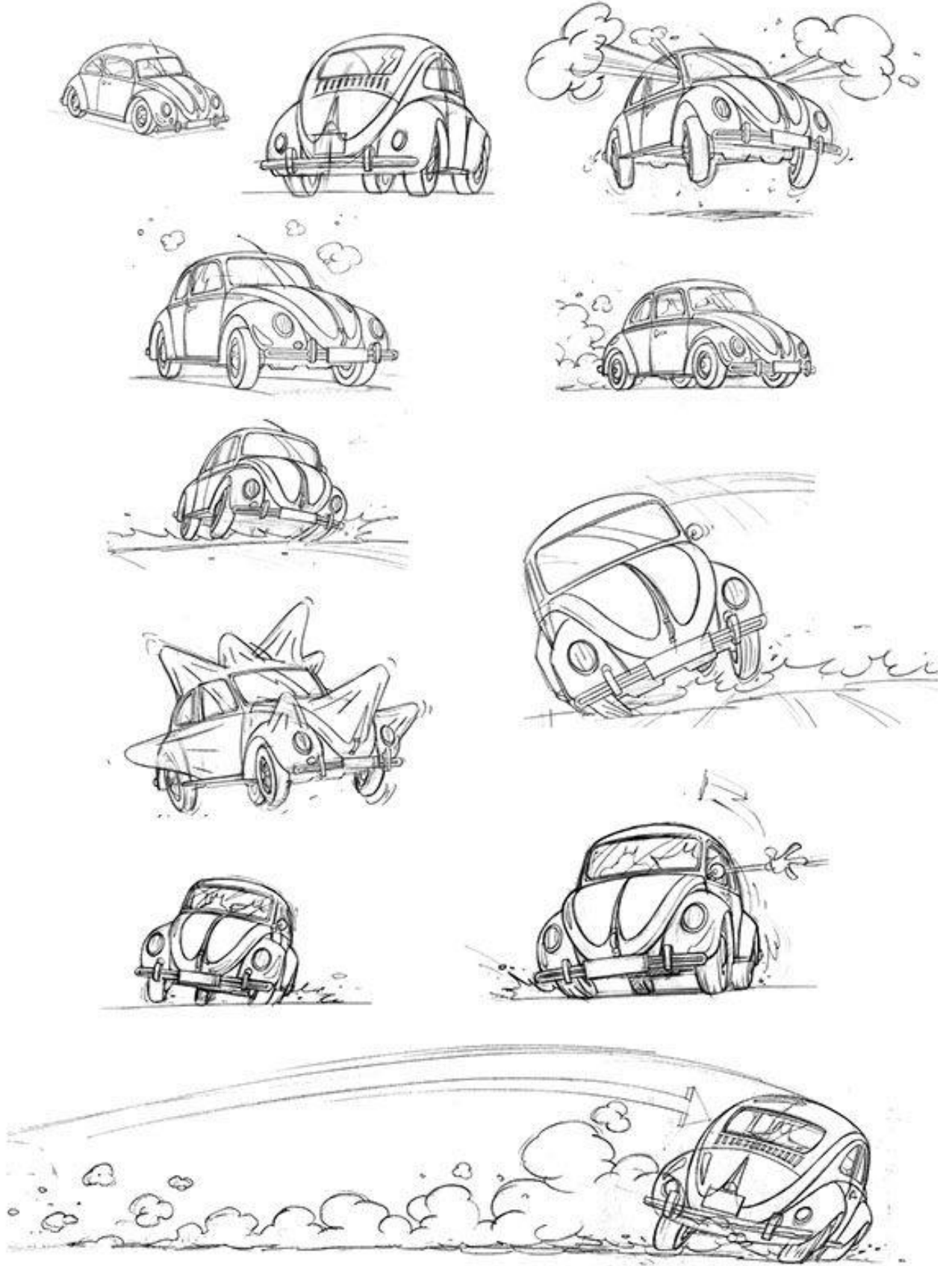

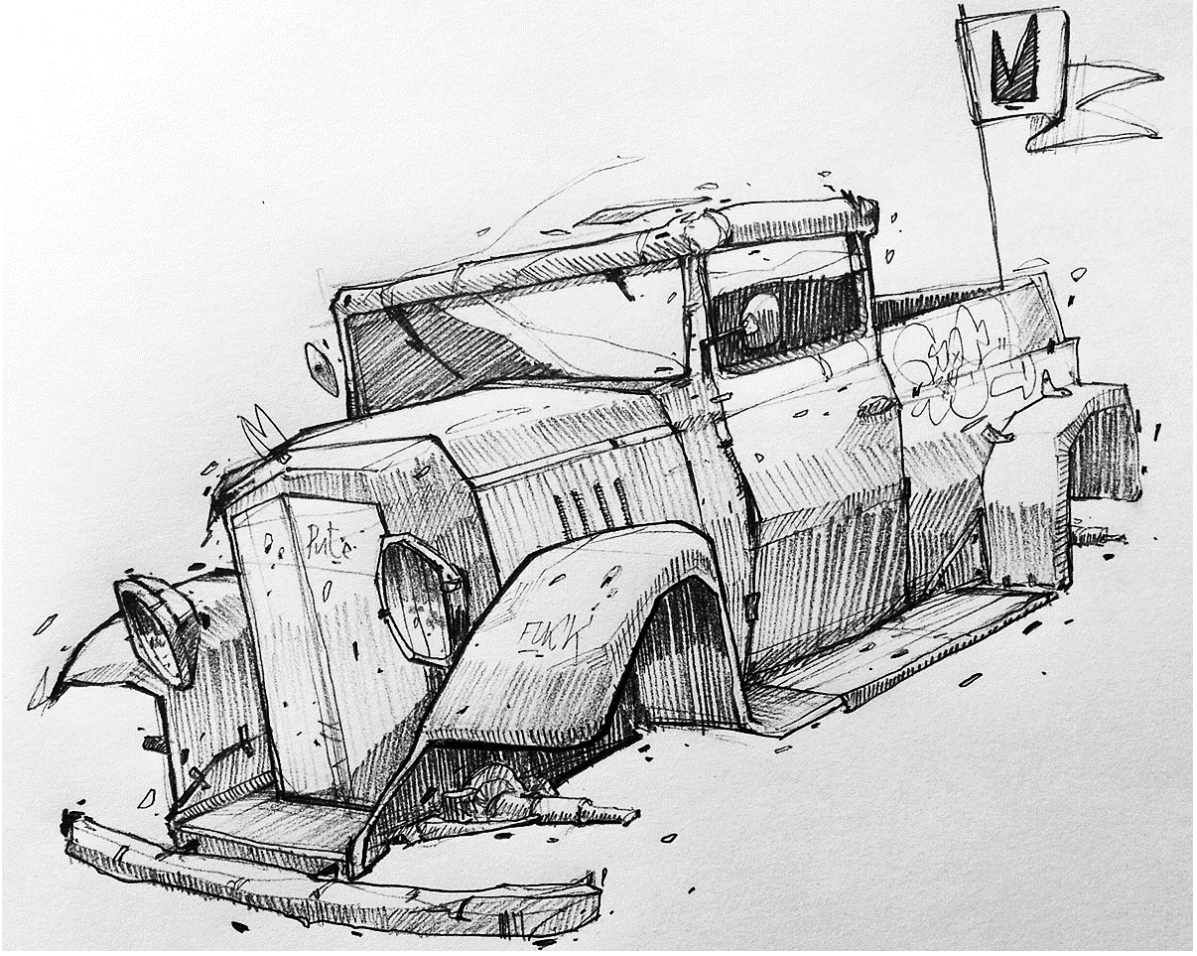

## İMGESEL ALIŞTIRMALARI

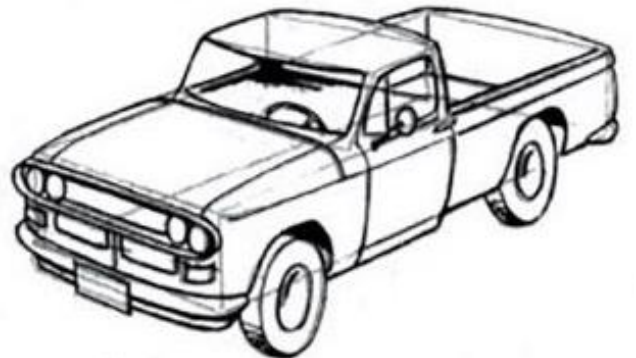
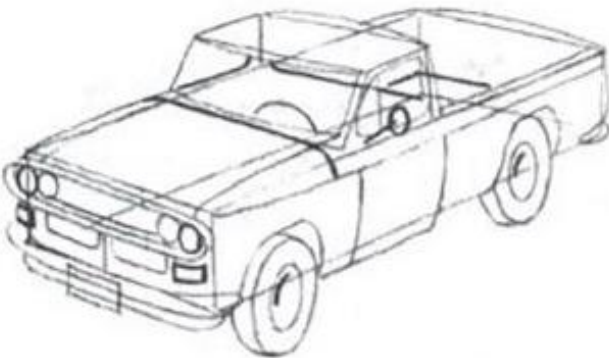
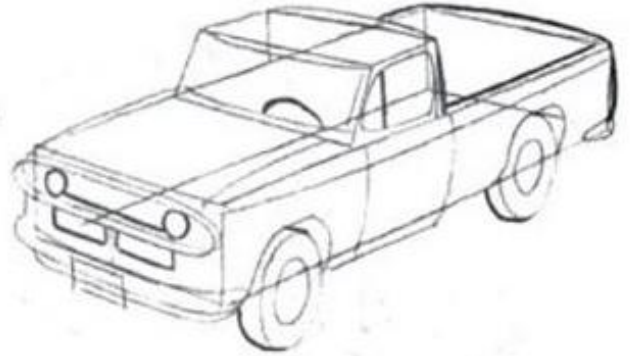
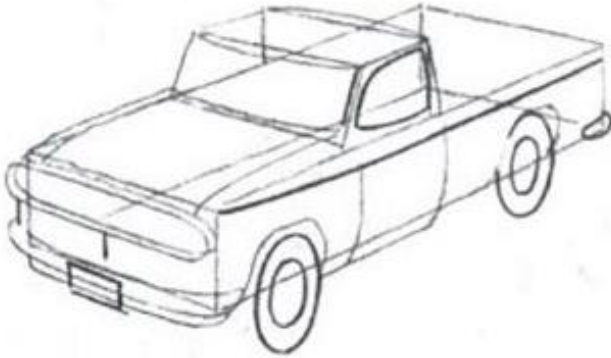
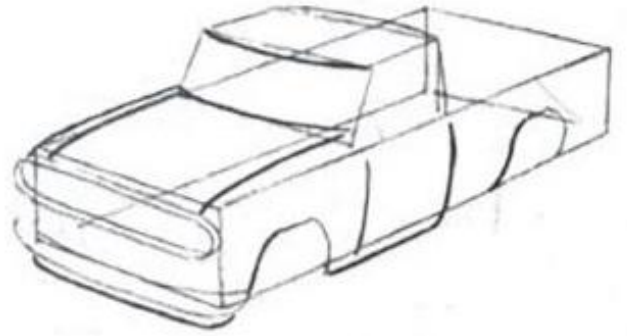
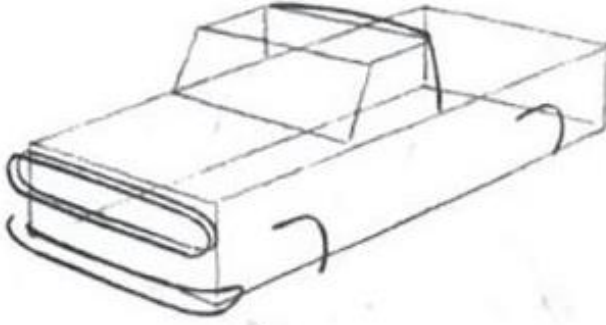
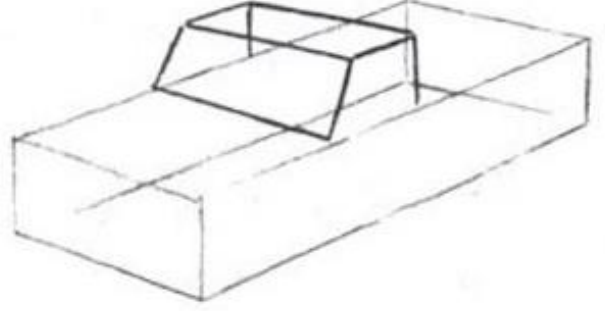
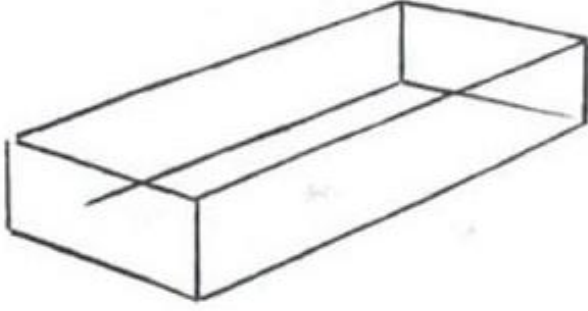

15/203

KIM J.H

2014

VOLKSWAGEN  
Beetle

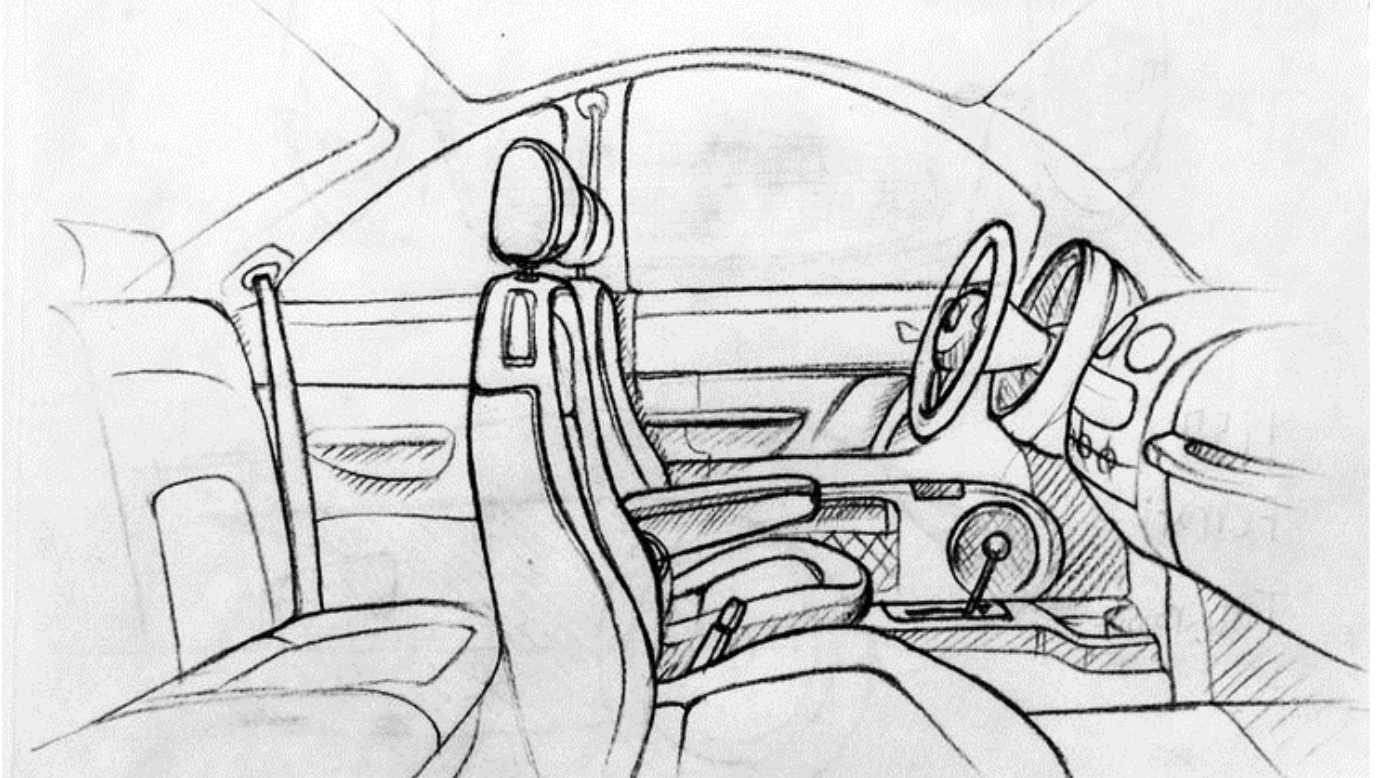
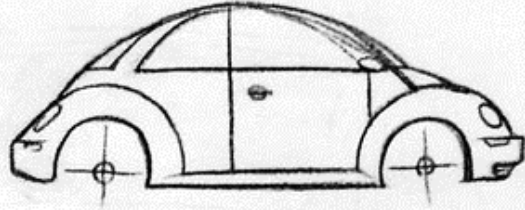
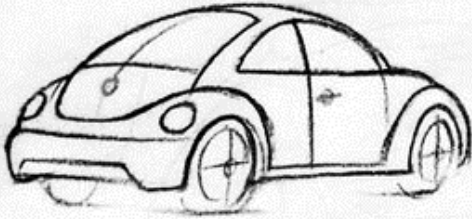
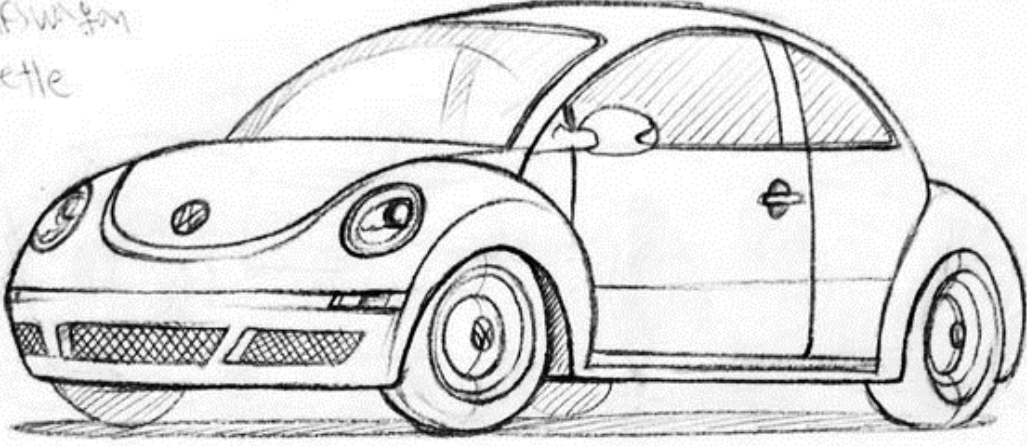

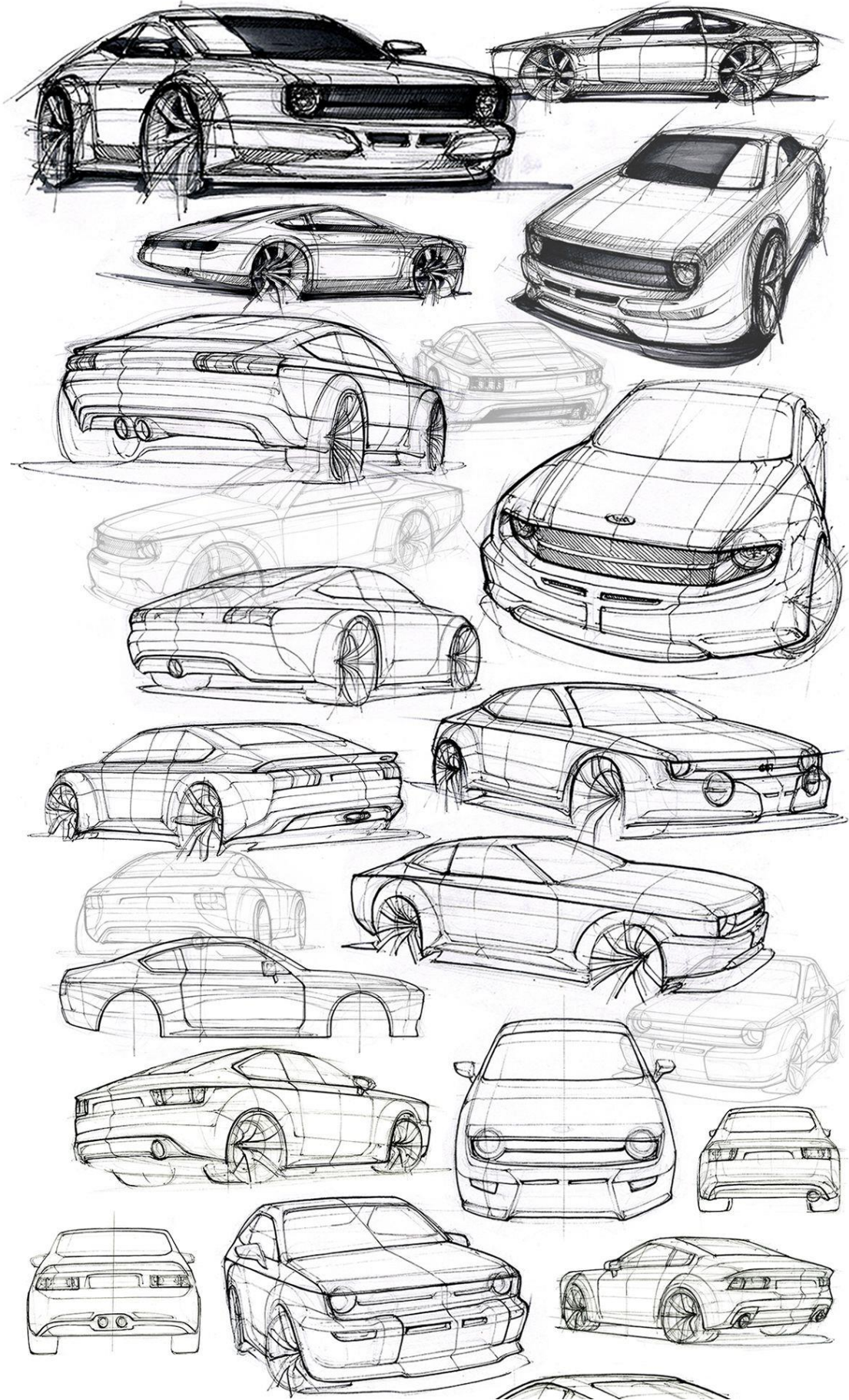

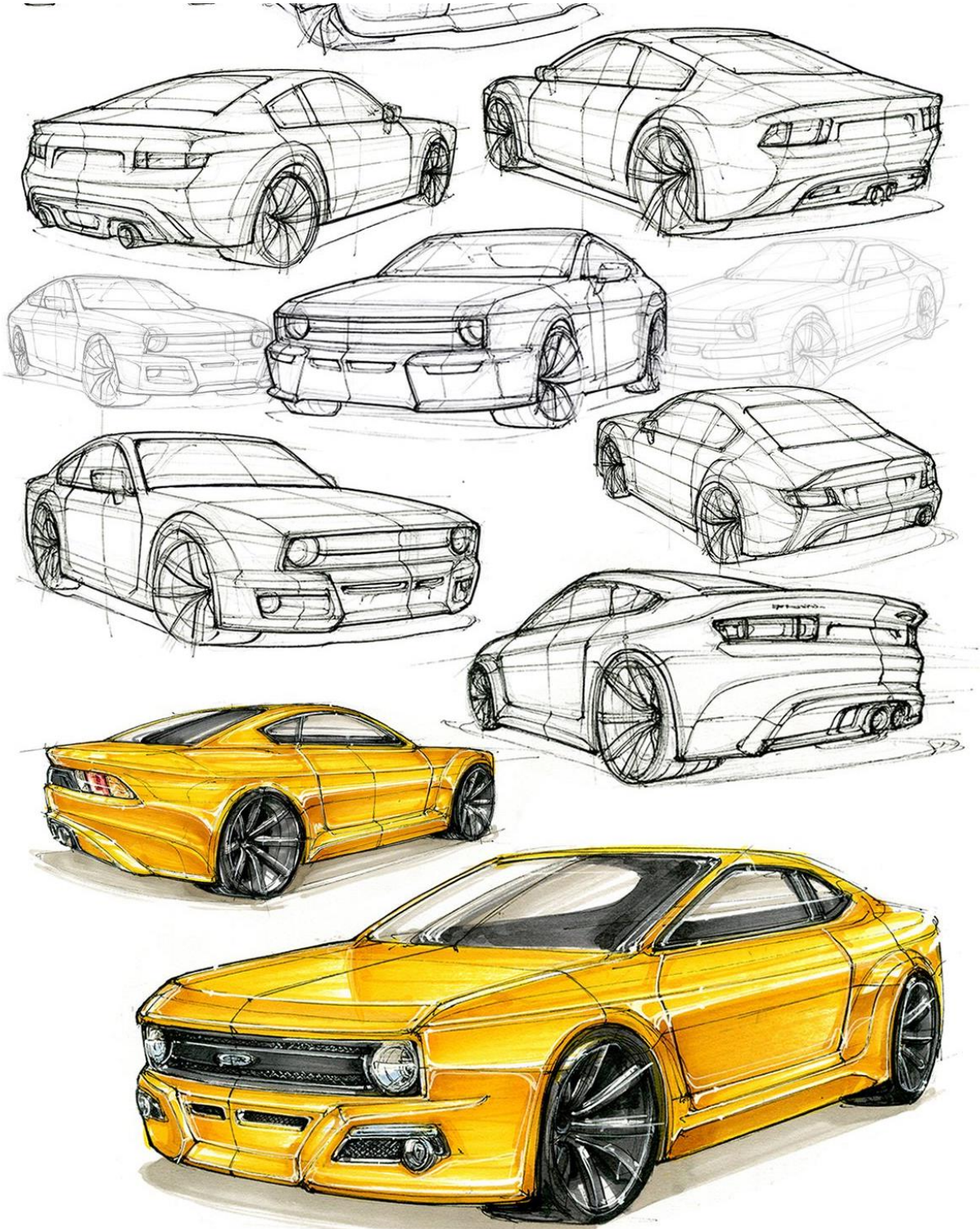

**WKS**  
REDESIGN  
CORT

# İMGESEL ALIŞTIRMALARI

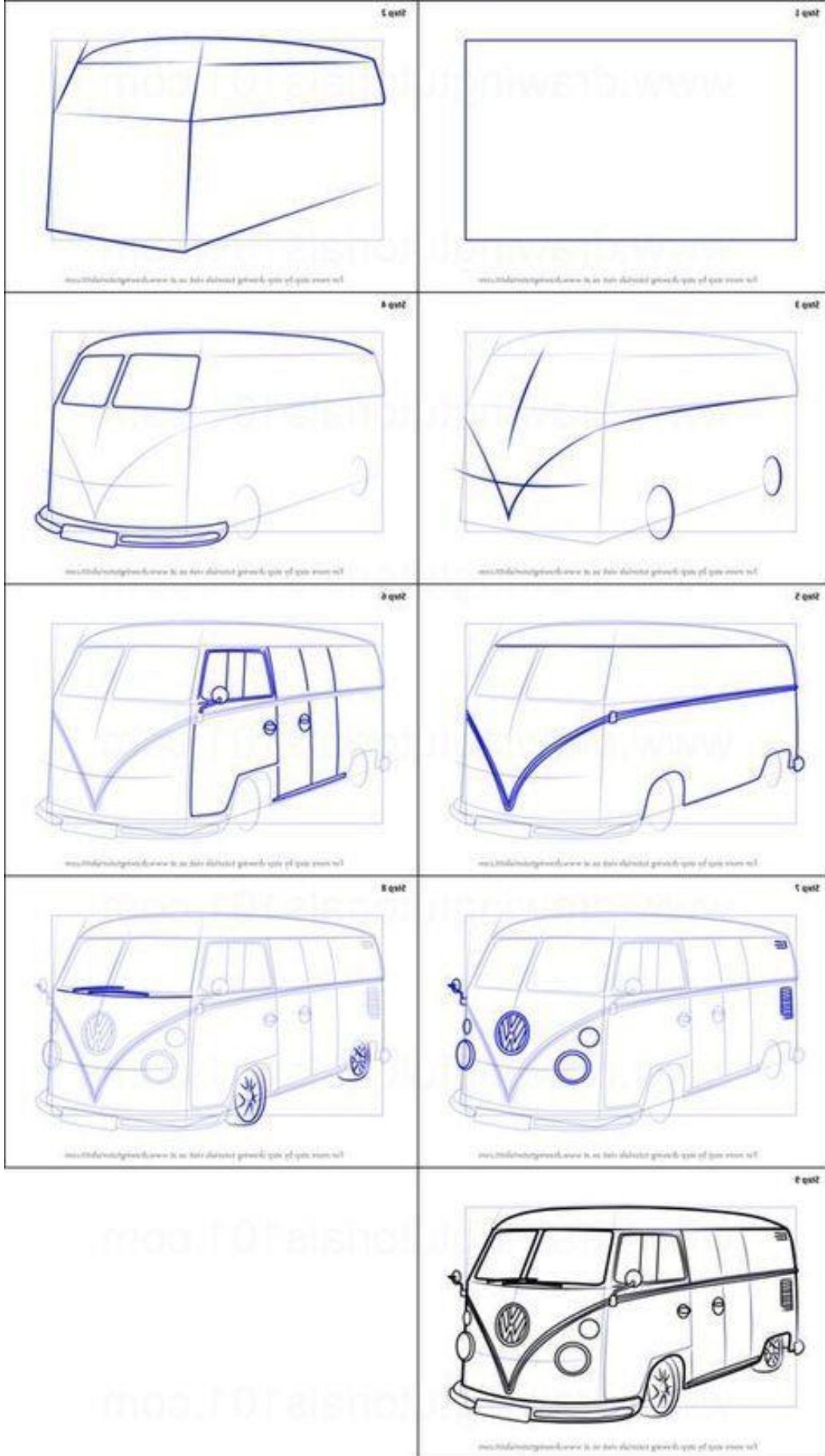



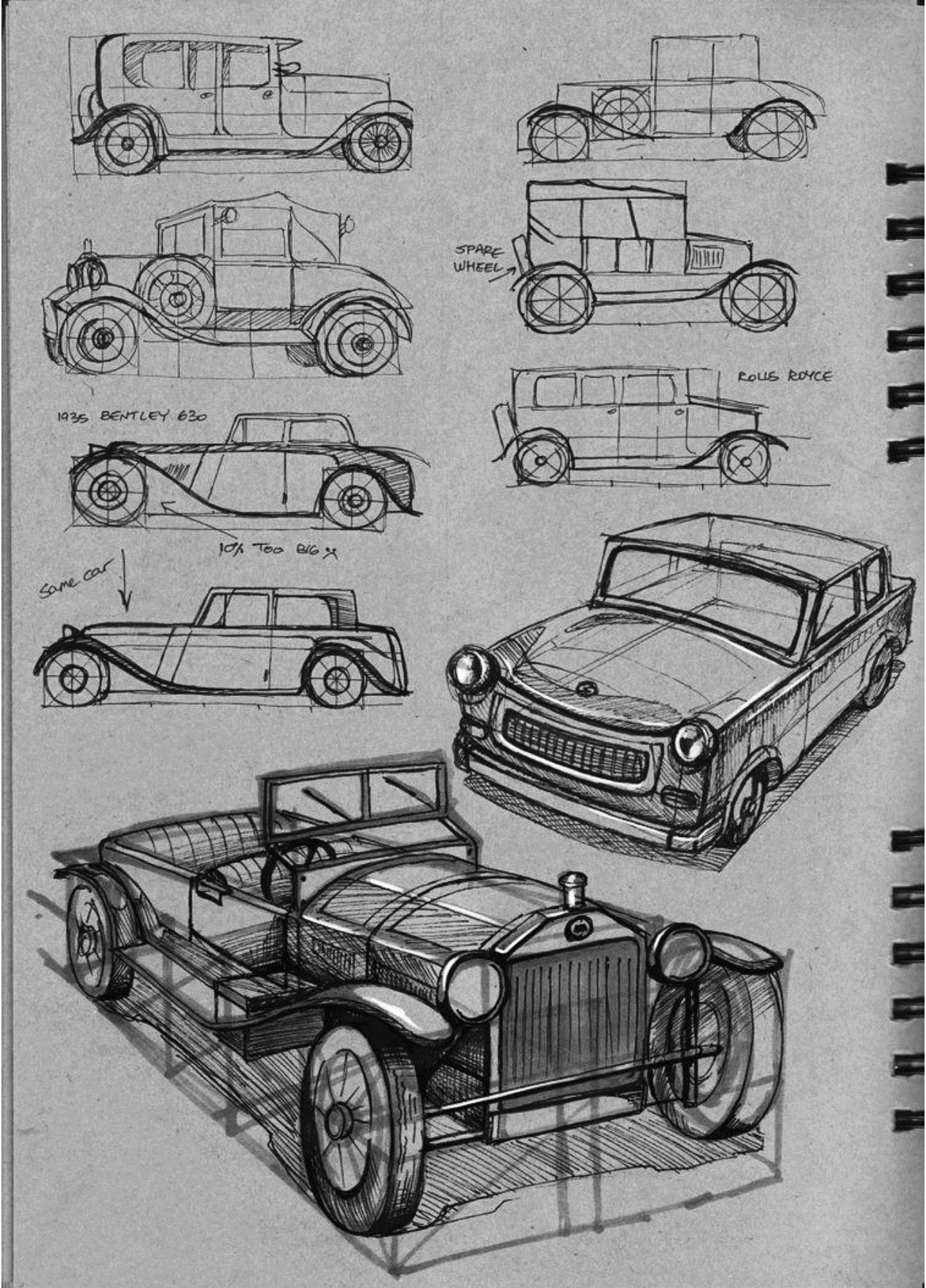

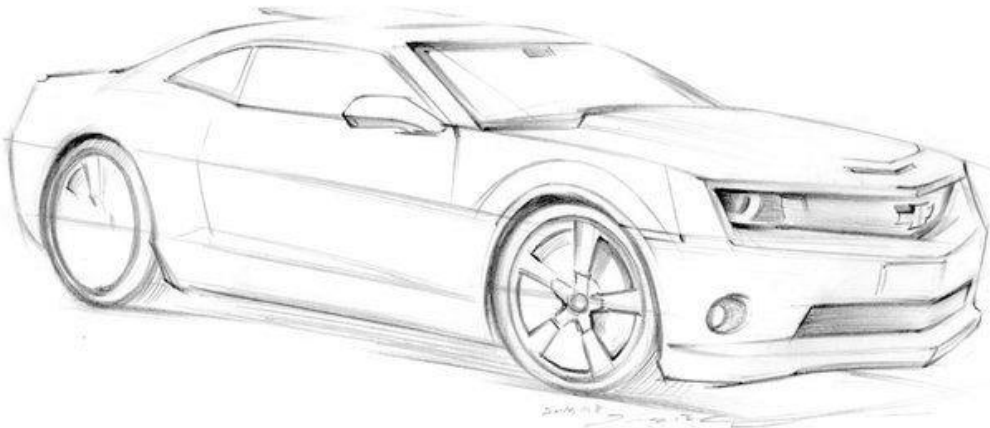
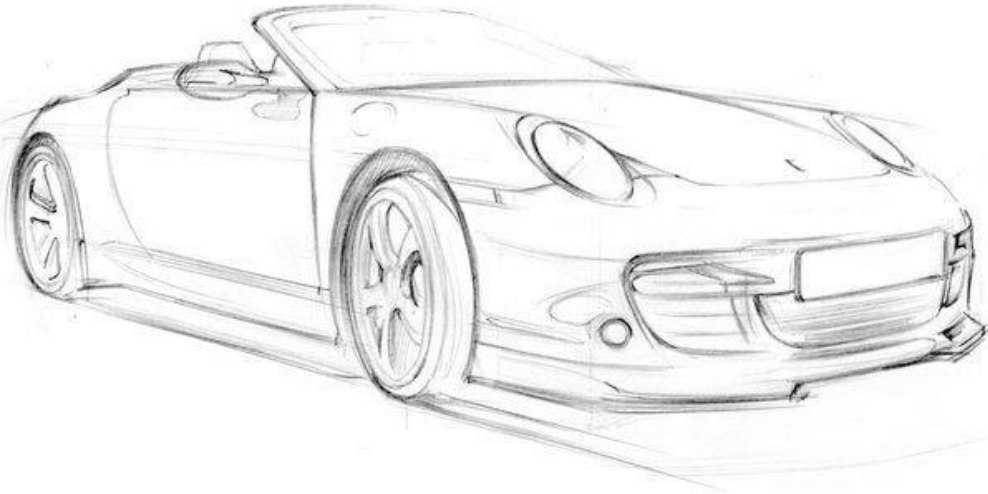
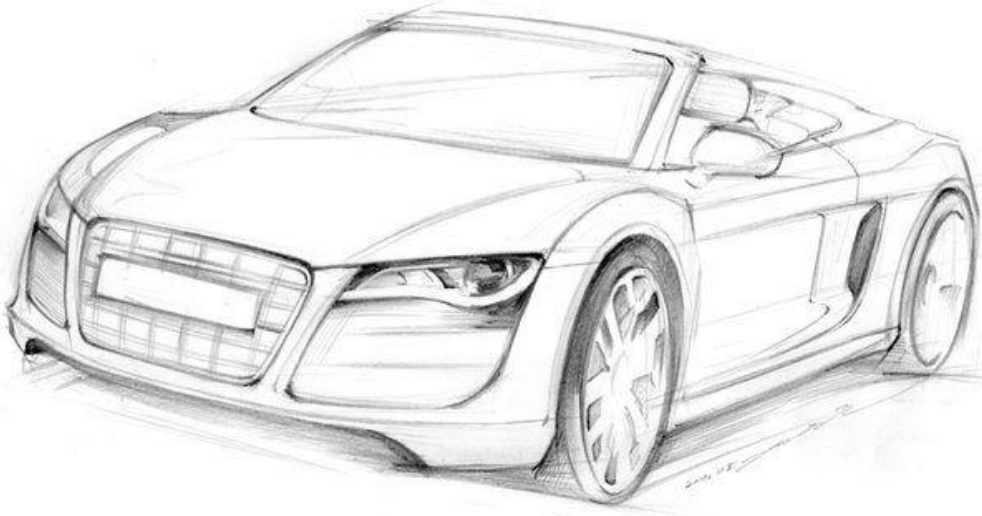

1

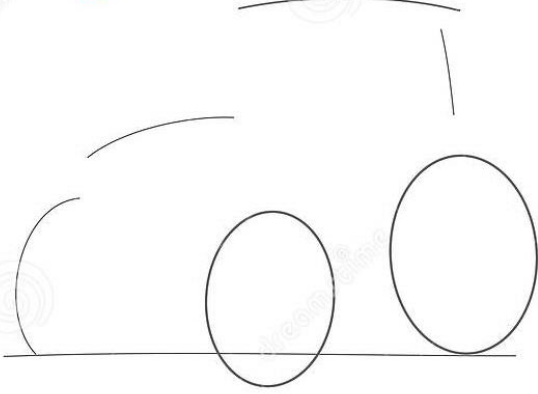

2

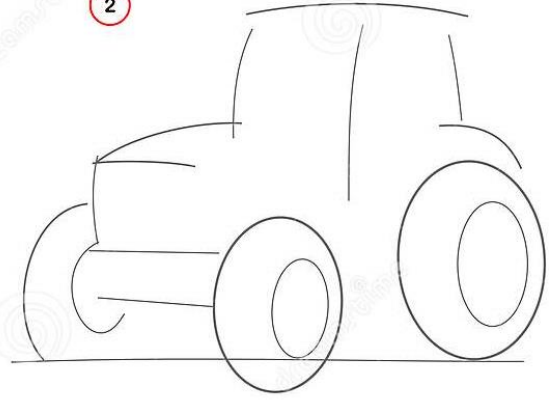

3

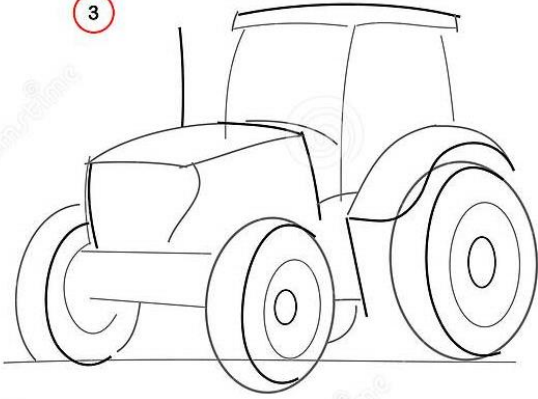

4

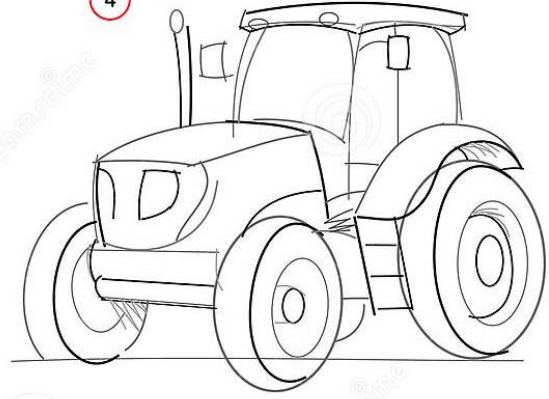

5

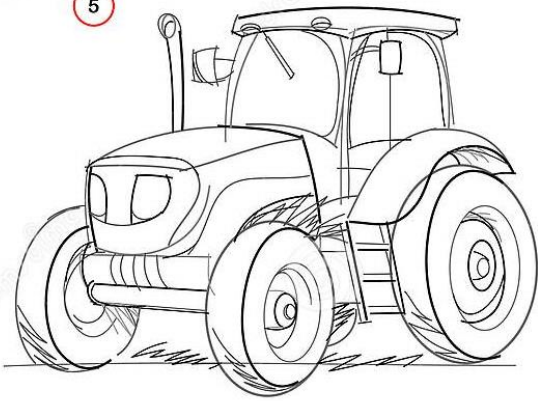

6

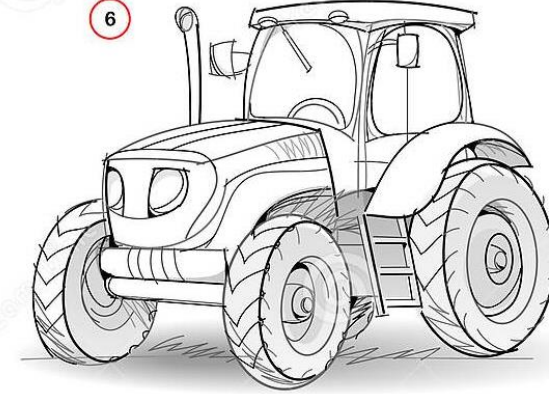

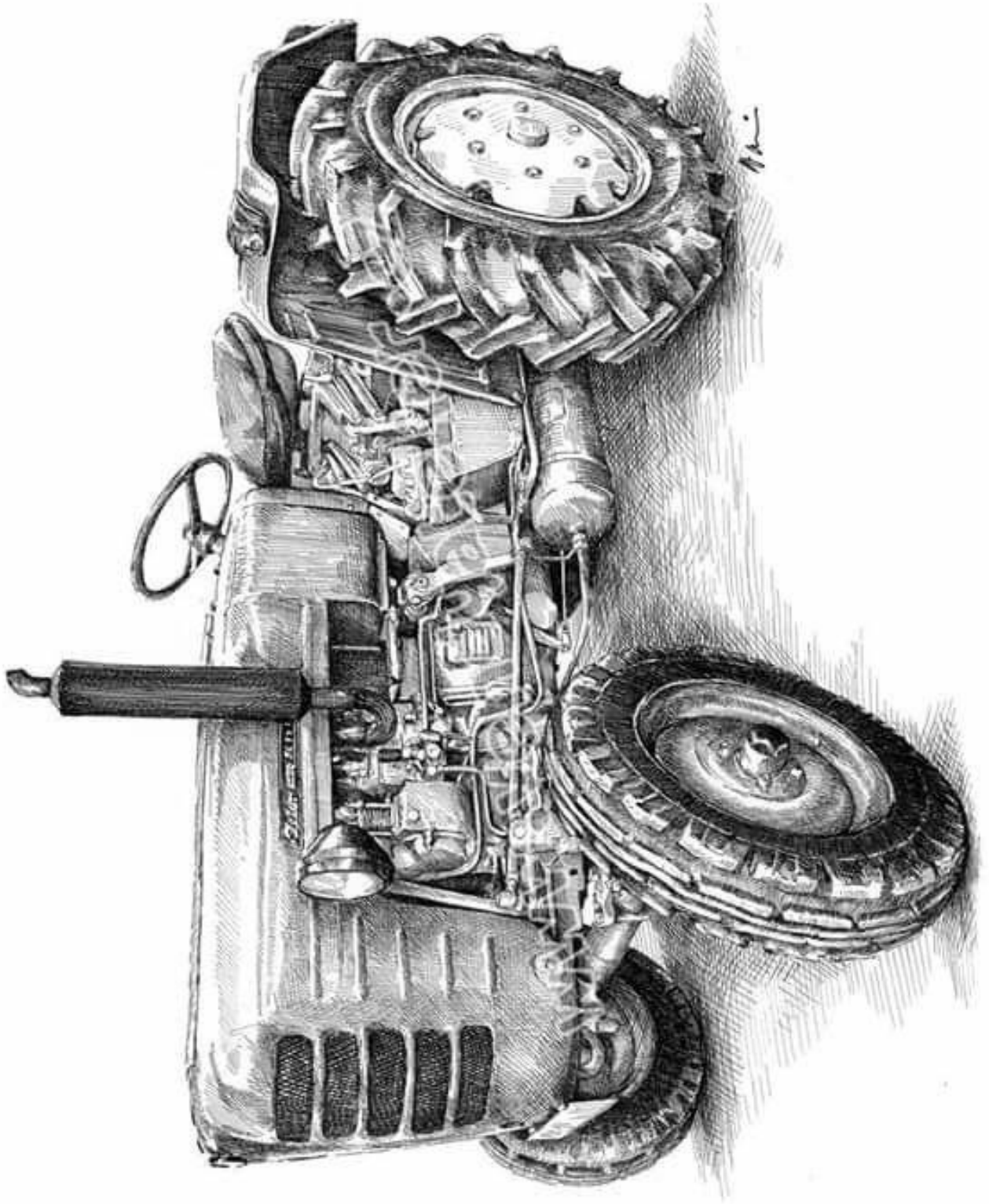

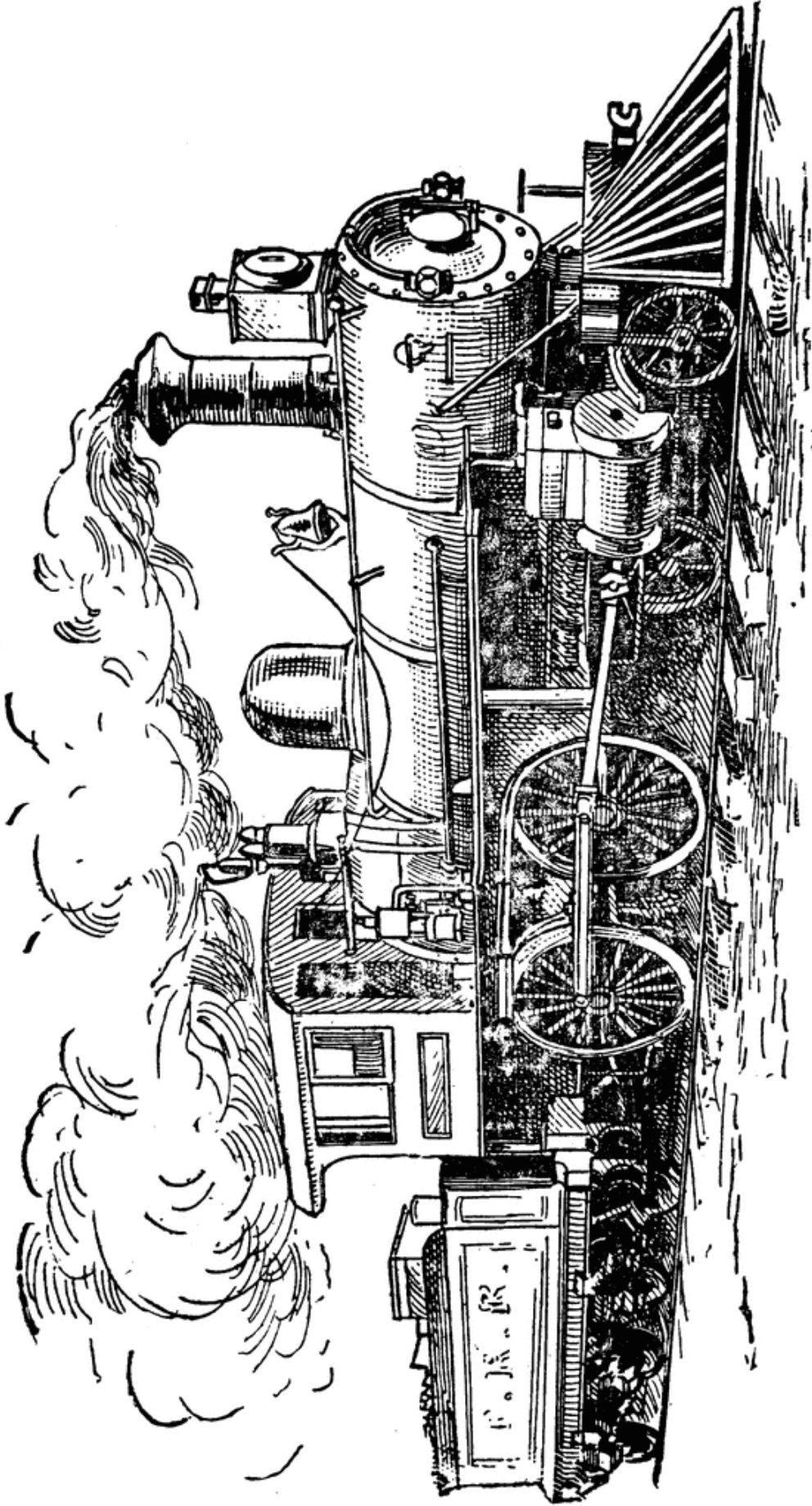



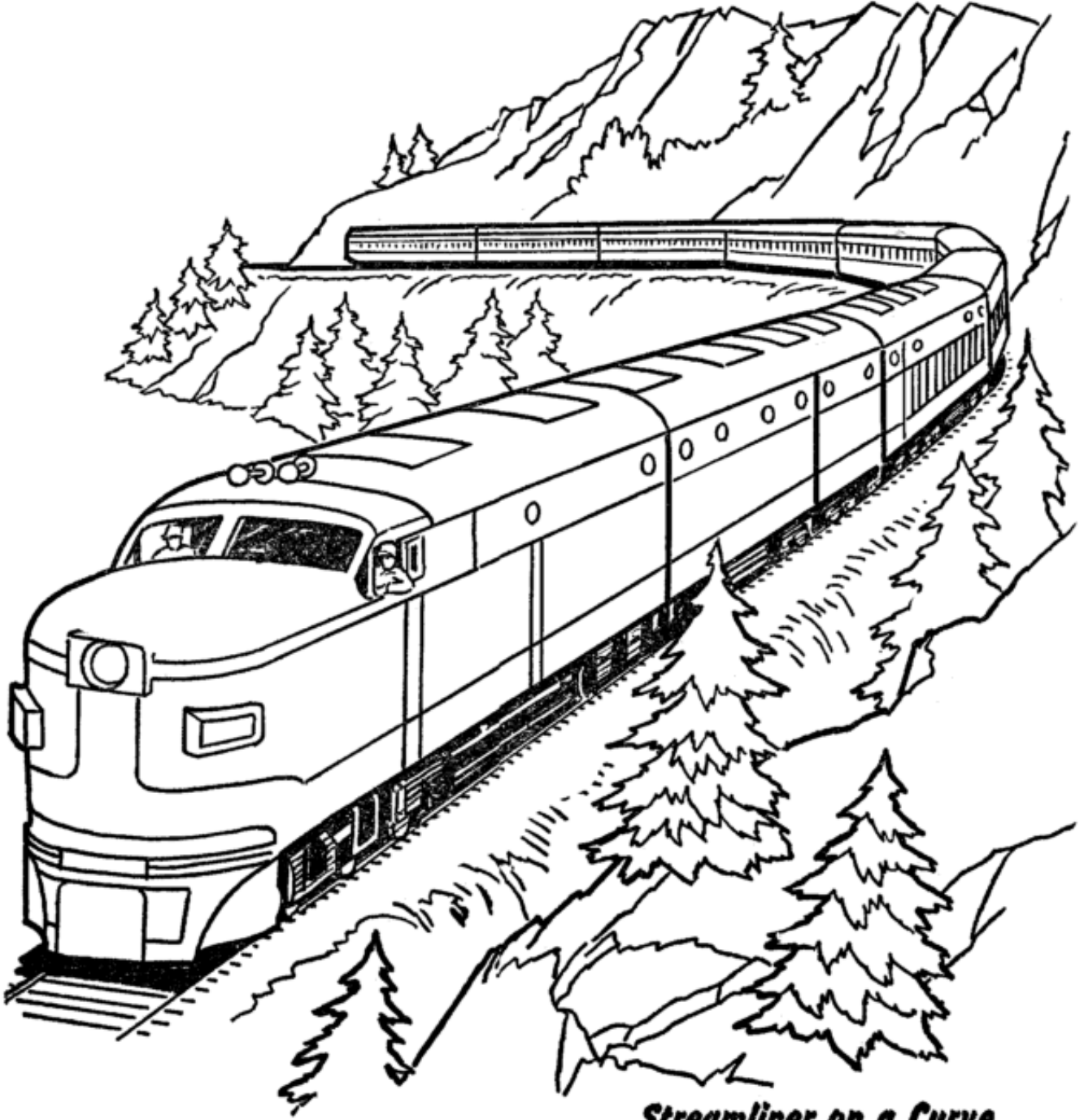

***Streamliner on a Curve***





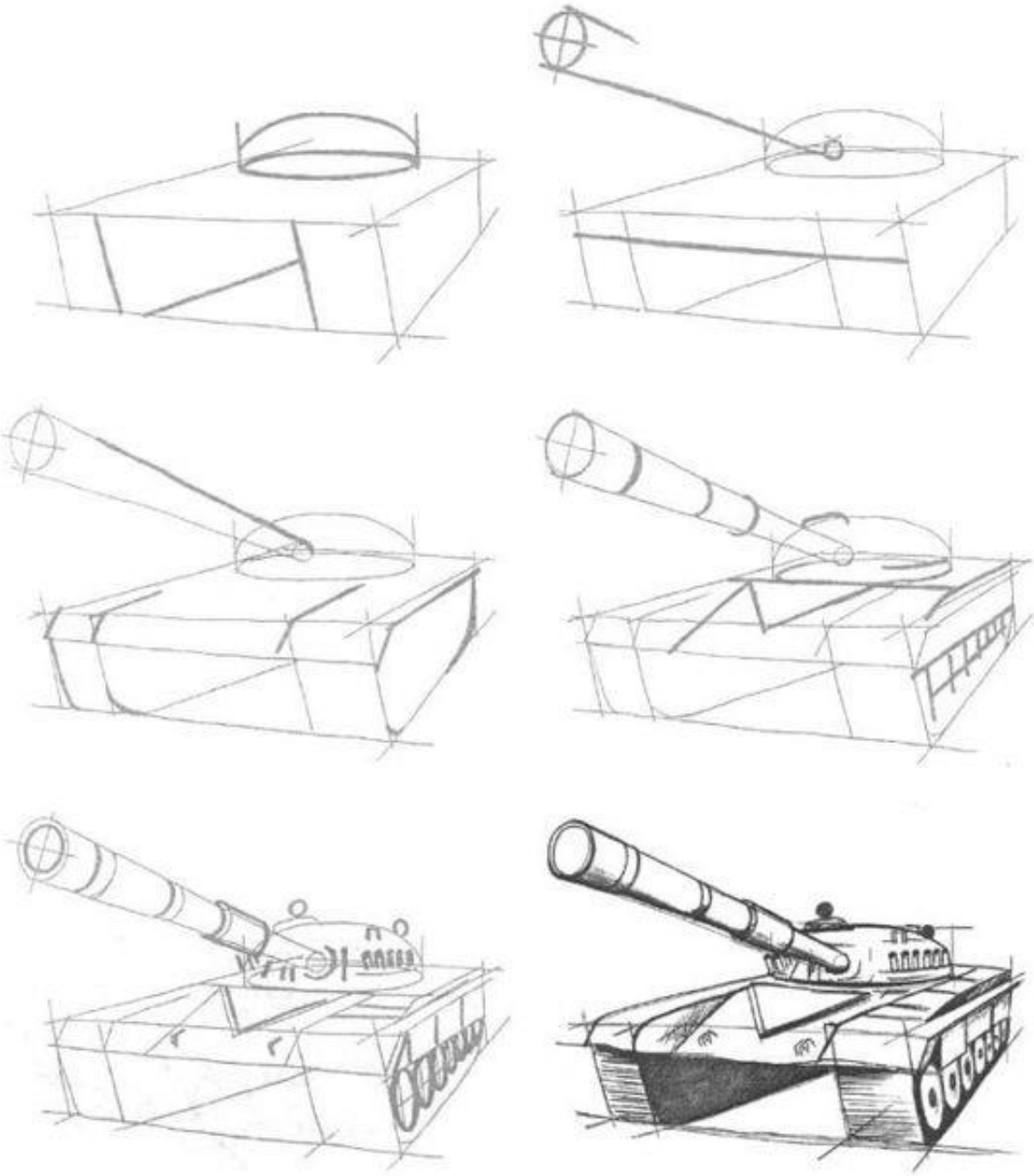



## Drawing A Plane



1



2

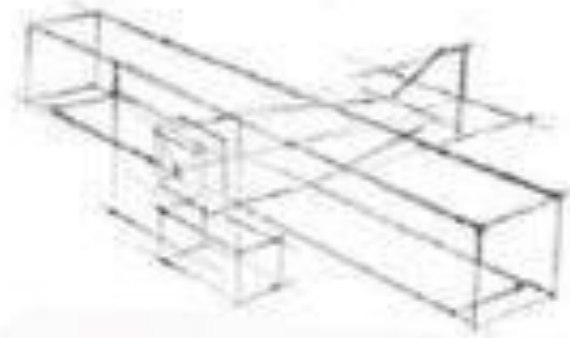

3

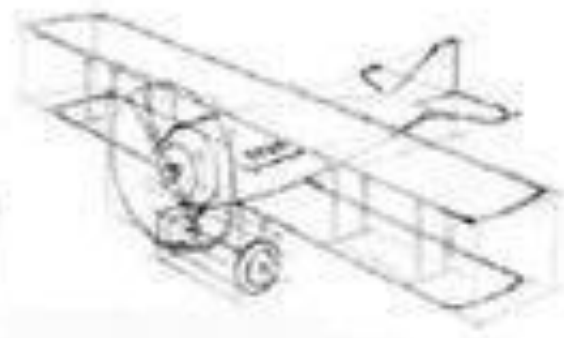

4

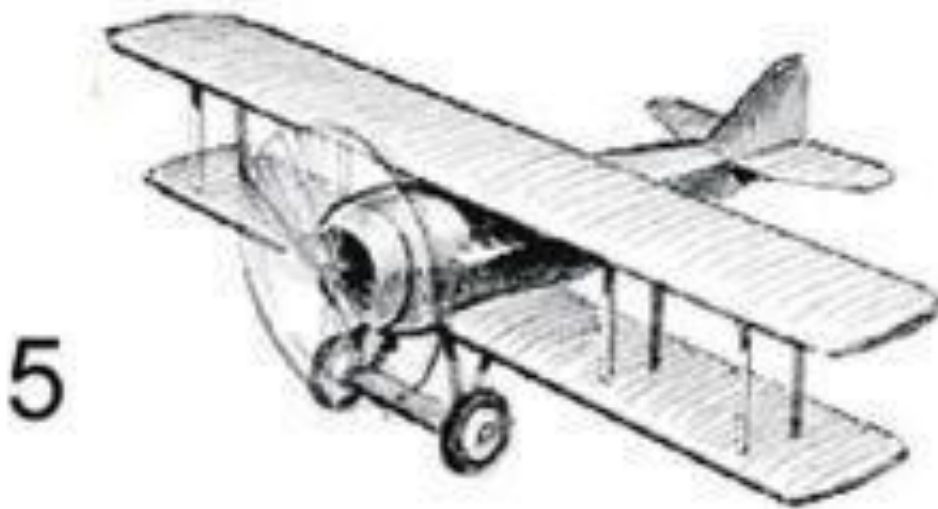

5

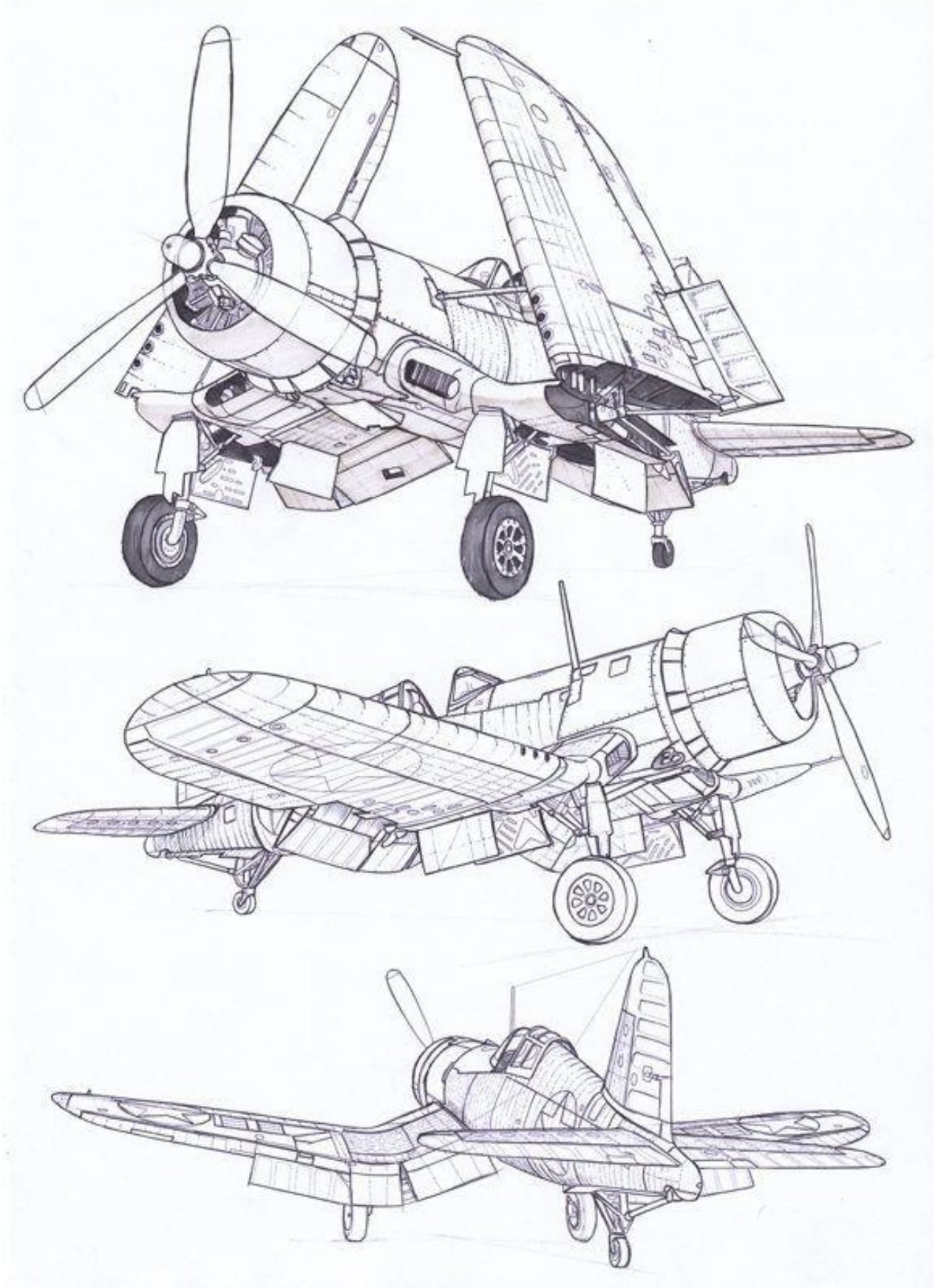

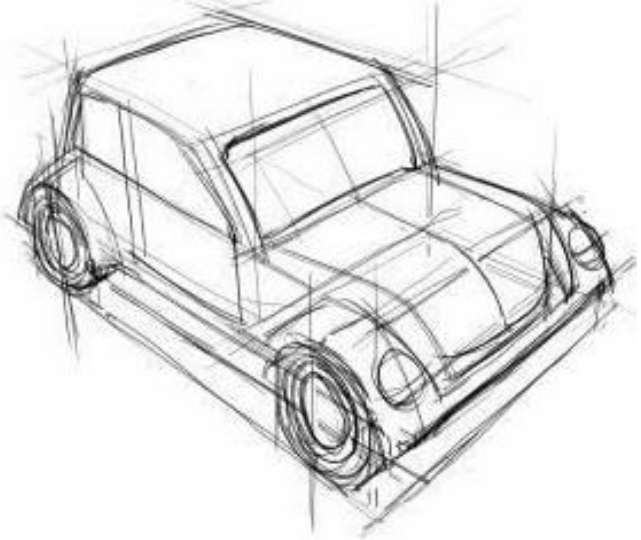
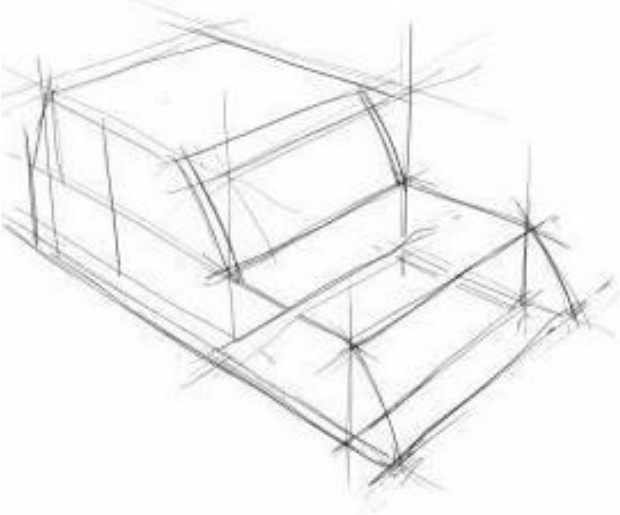
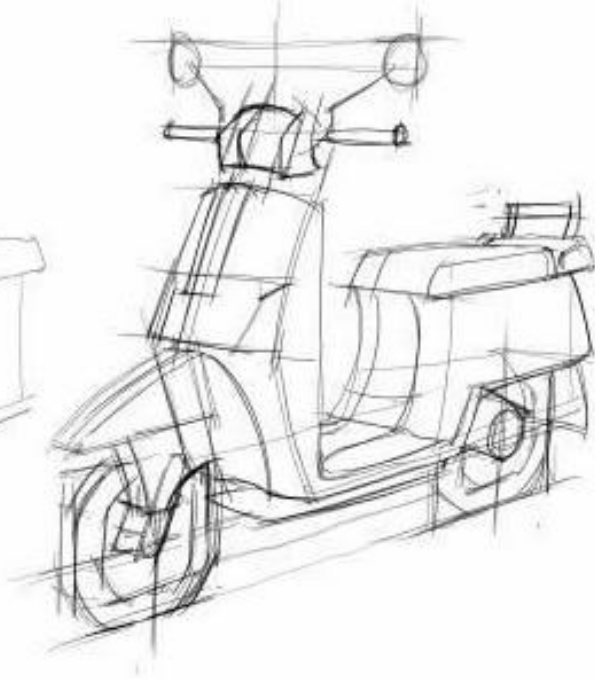
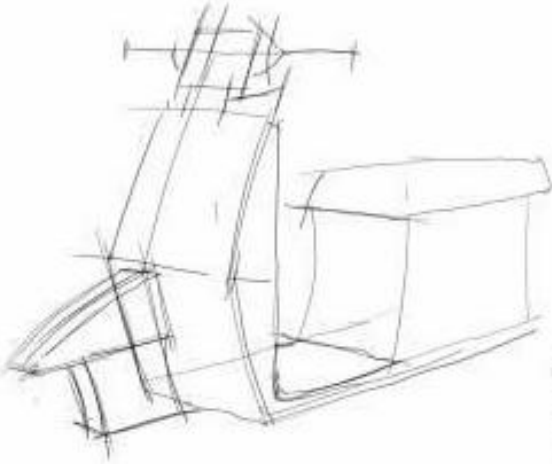
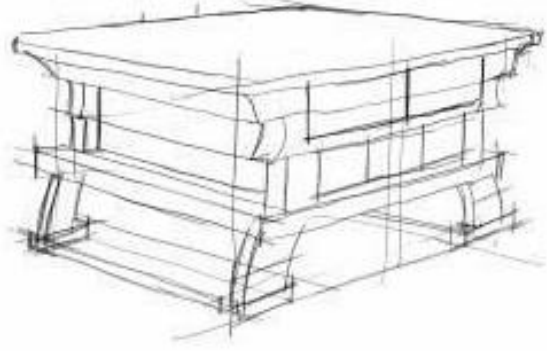

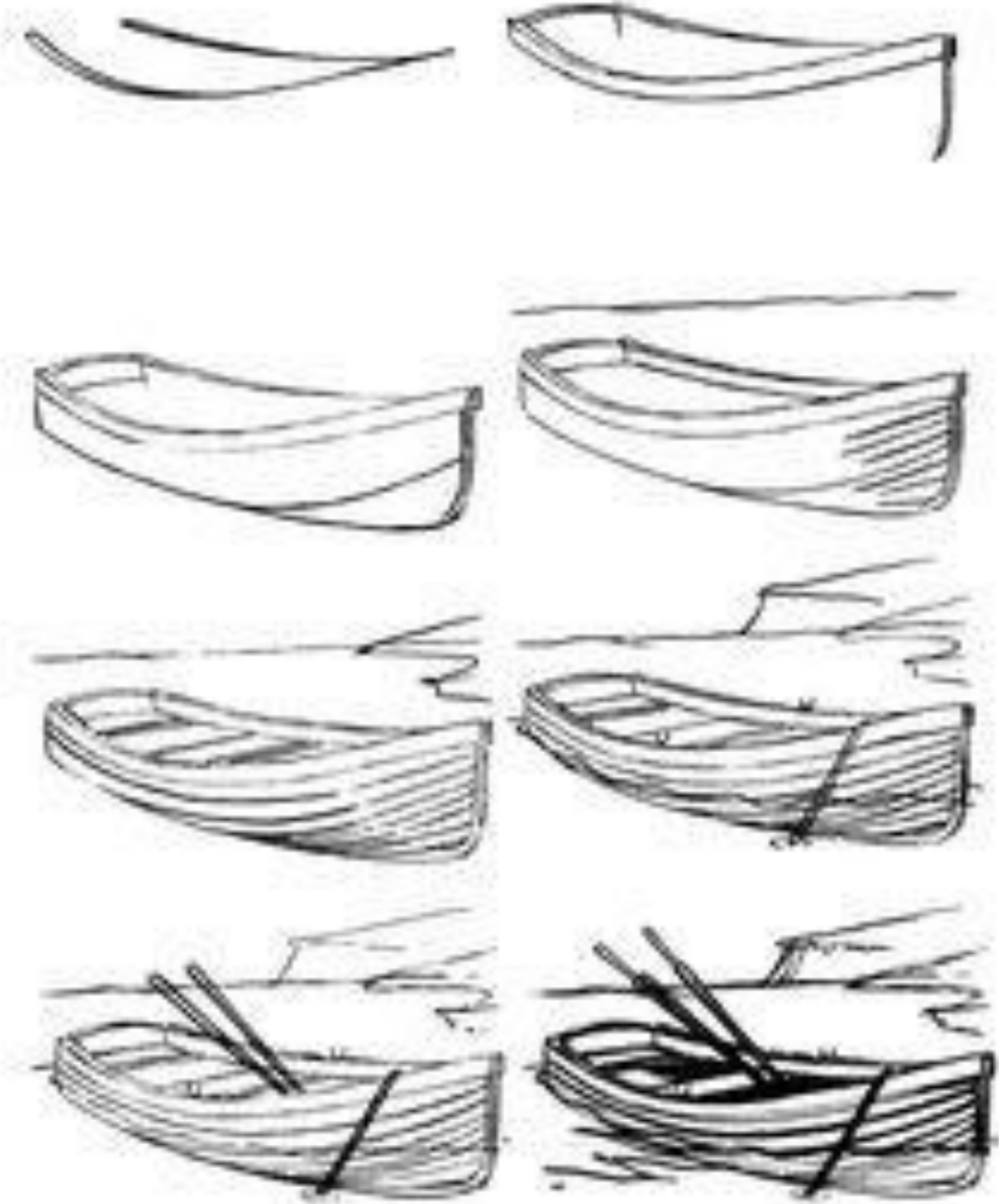







B- Eşyalar

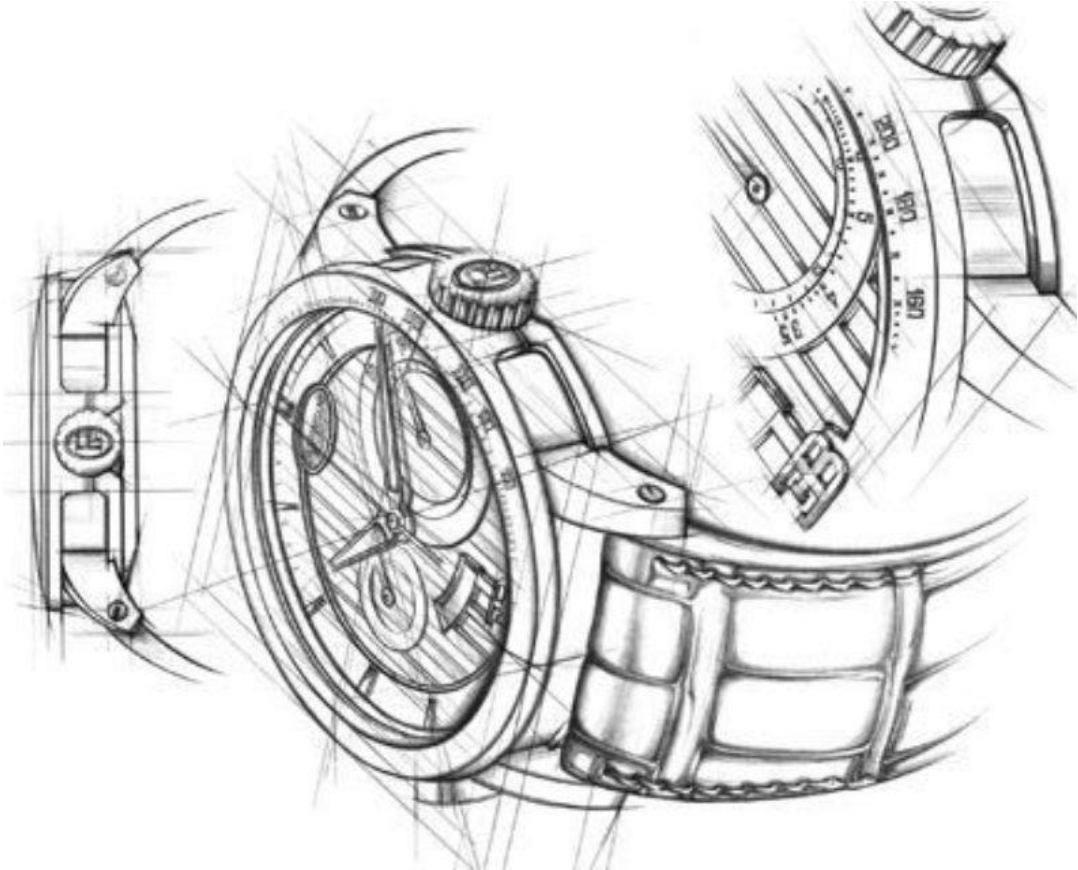
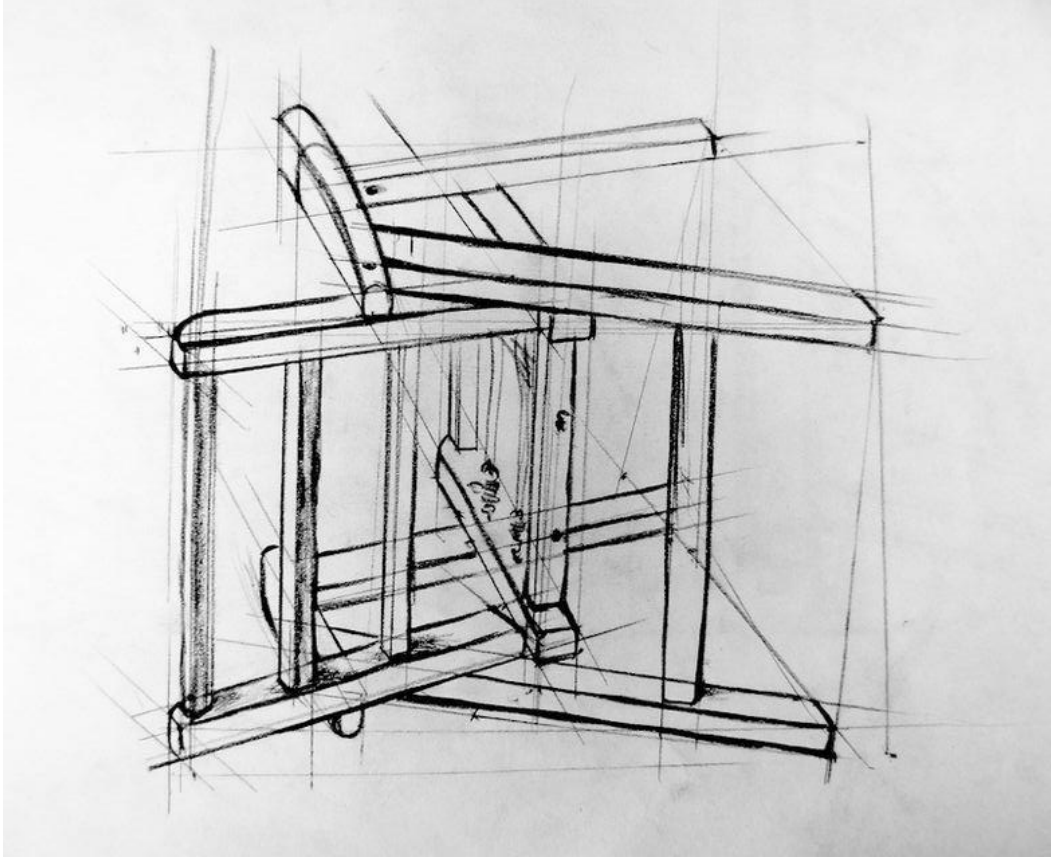

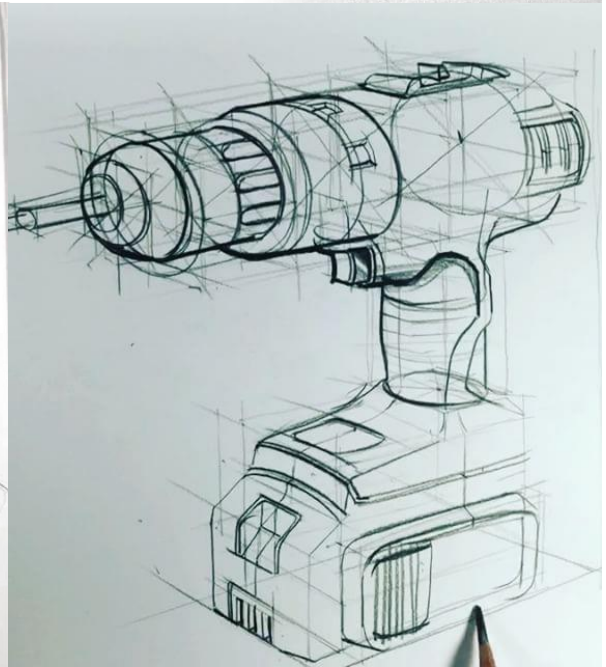
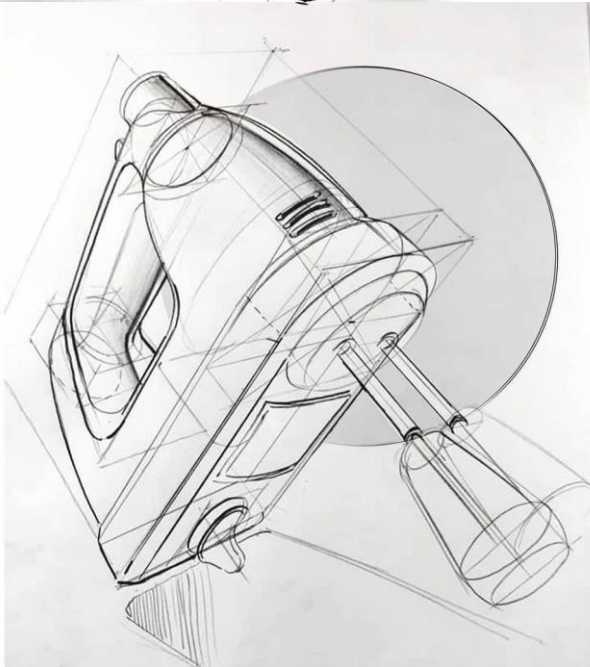
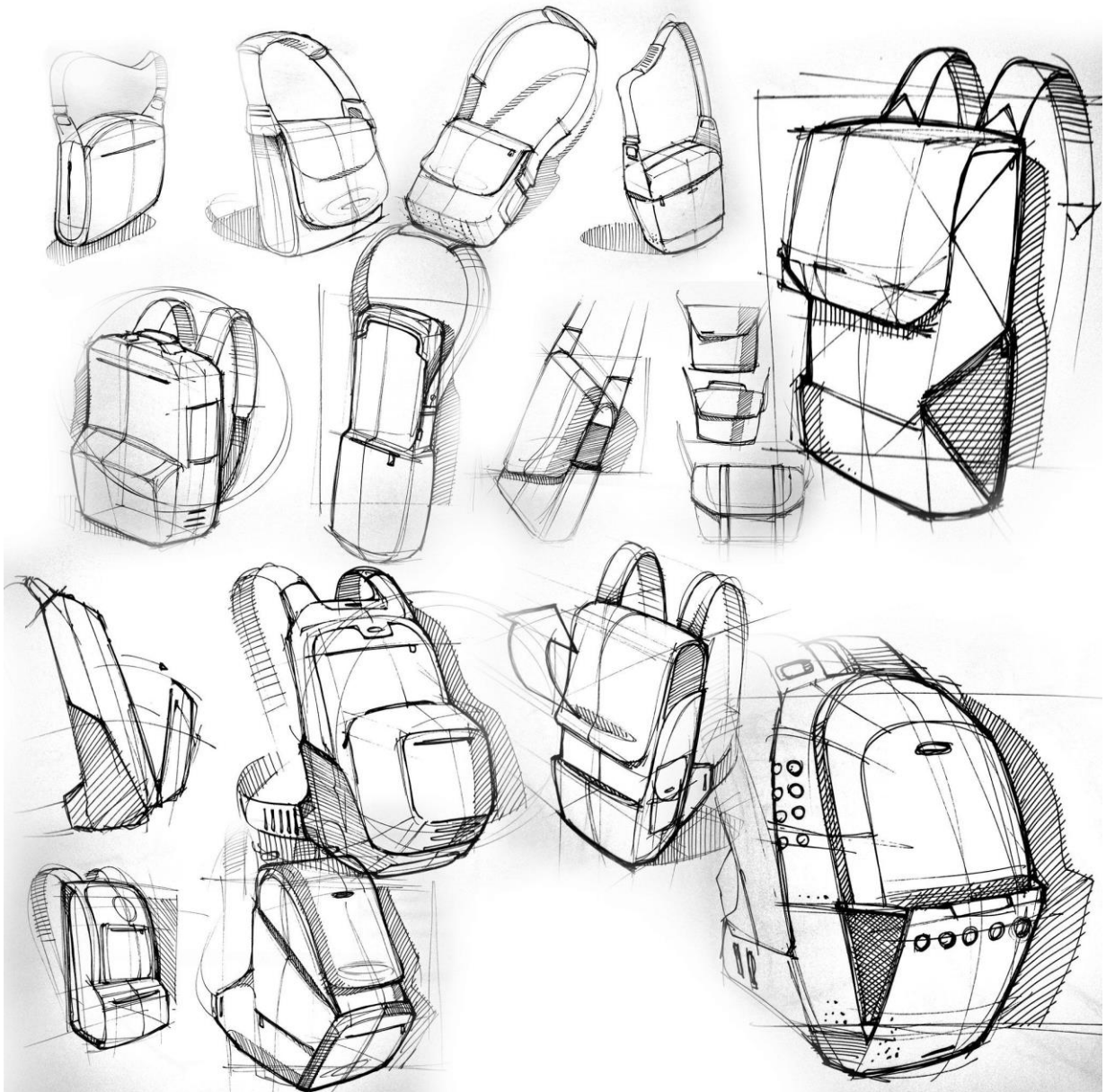

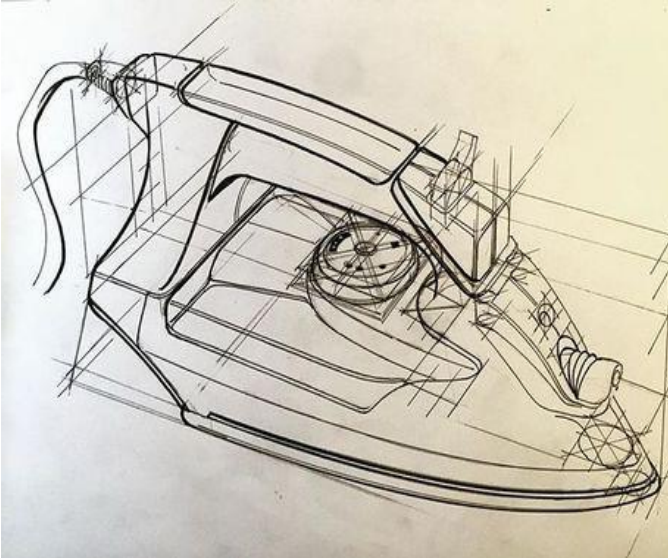
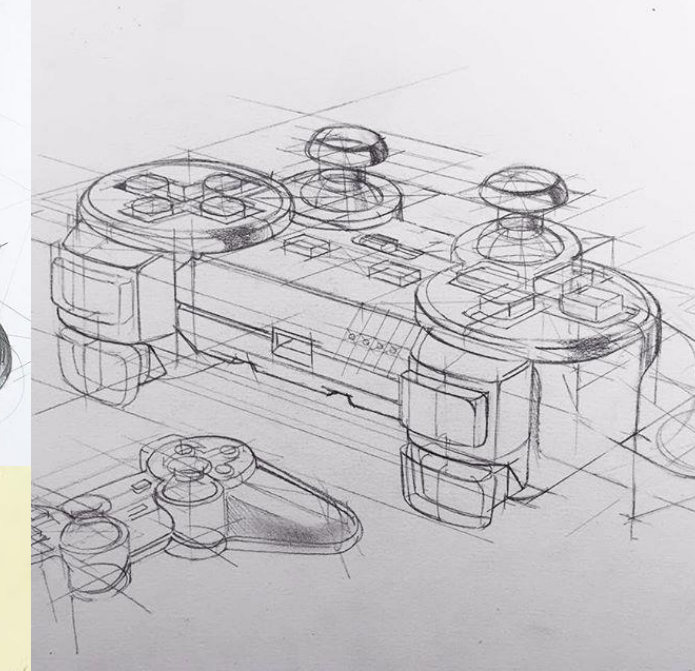
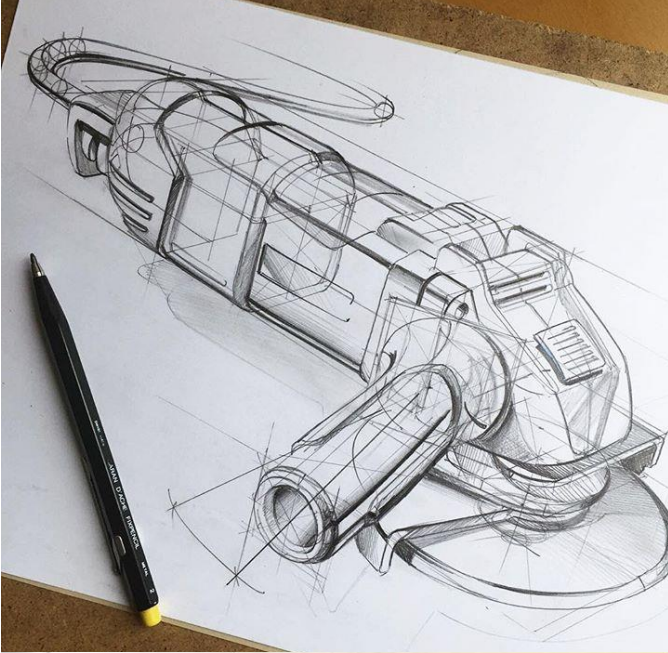
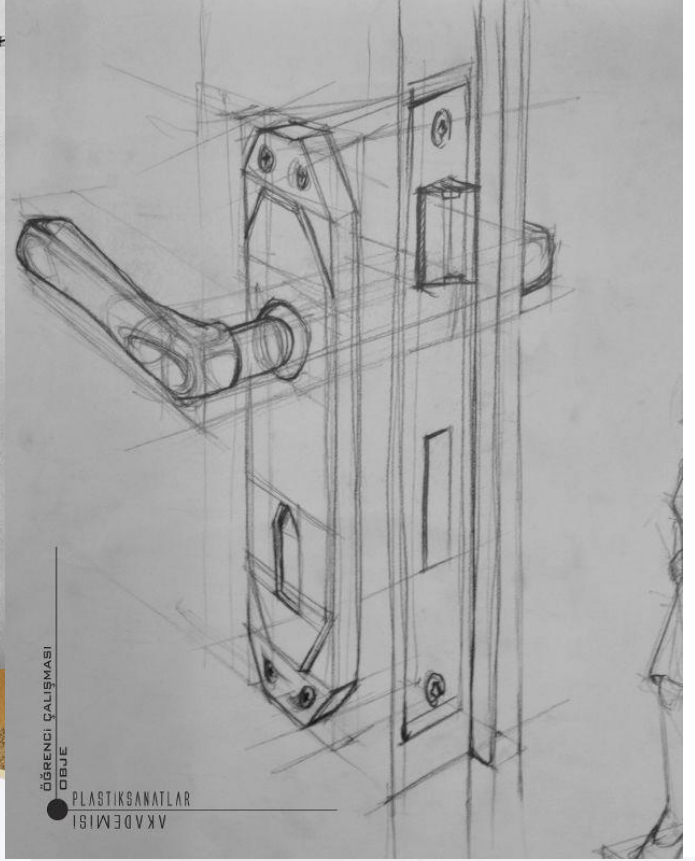
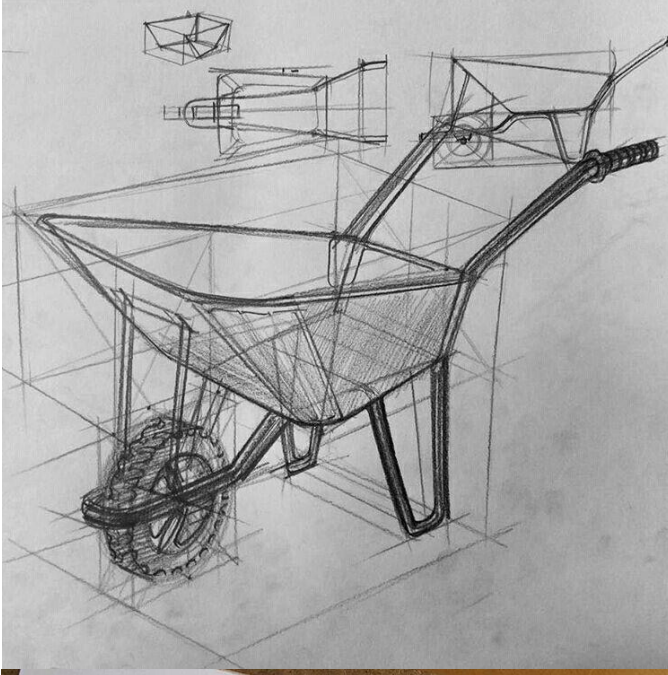

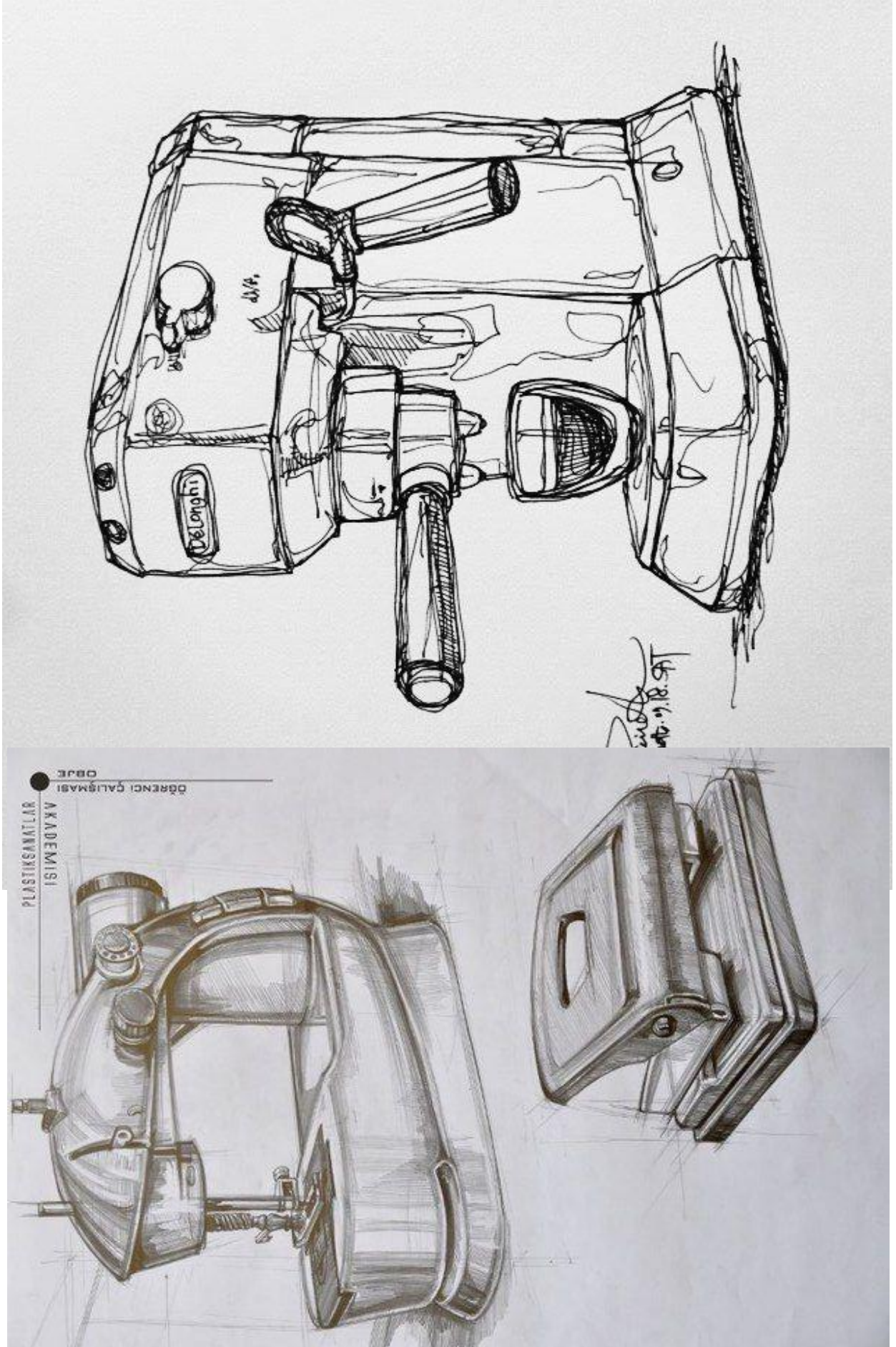

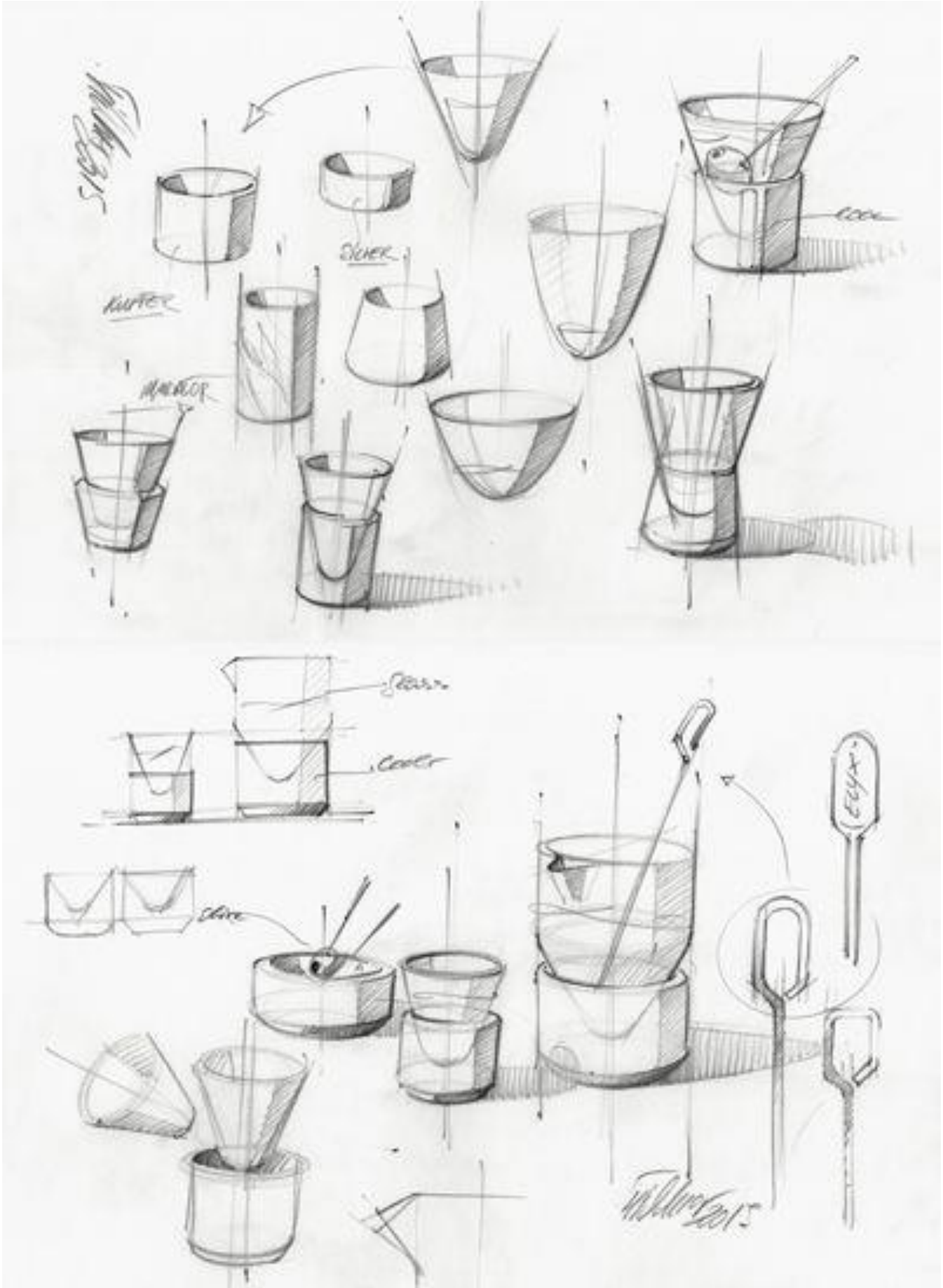

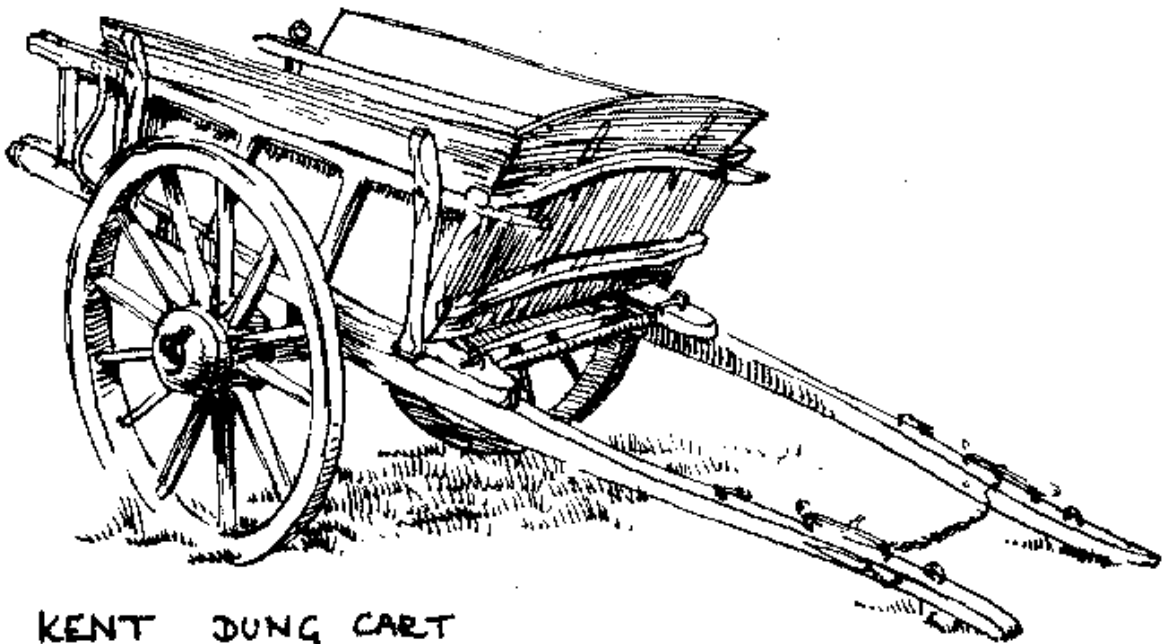
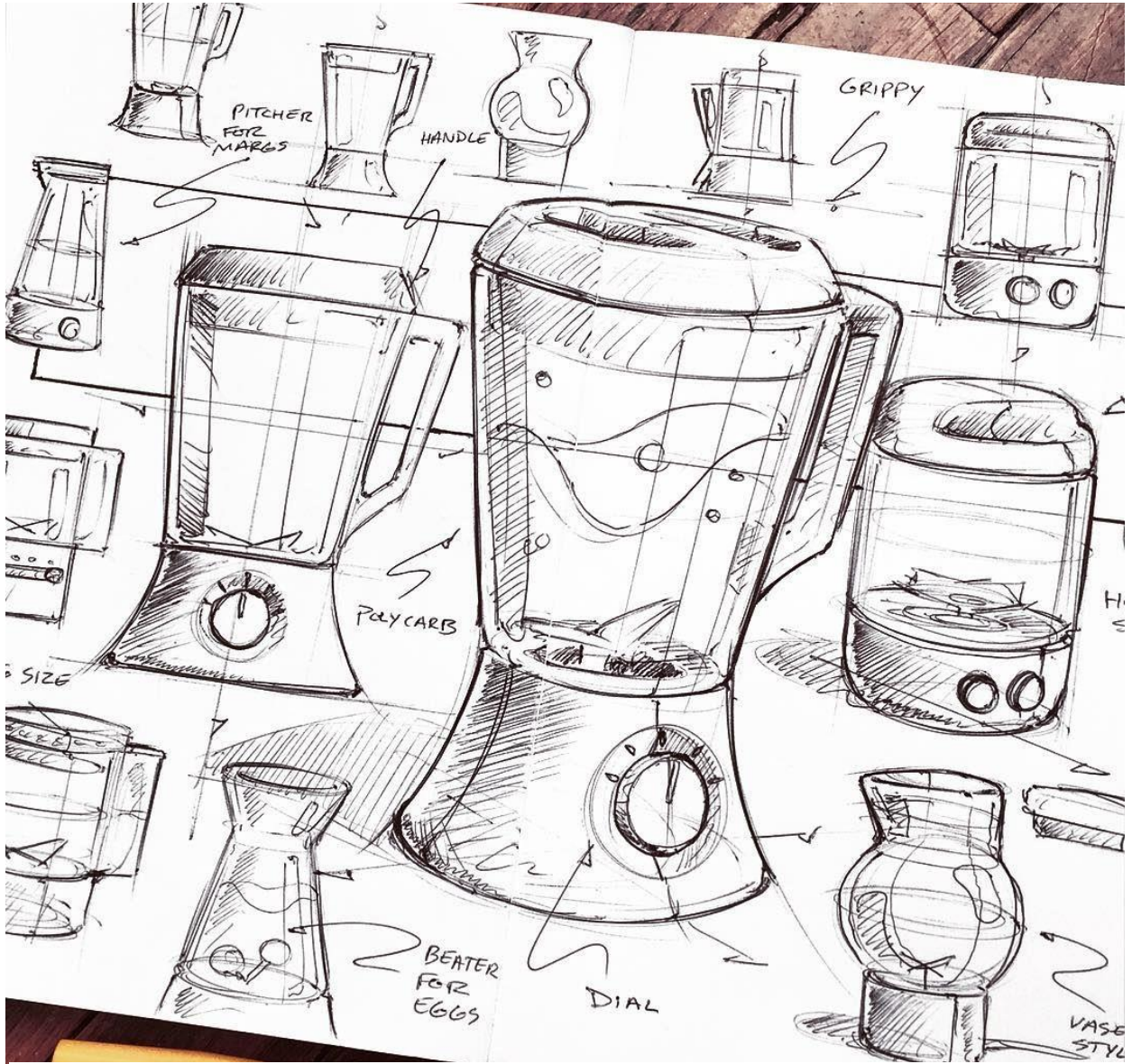

KENT DUNÇ CART

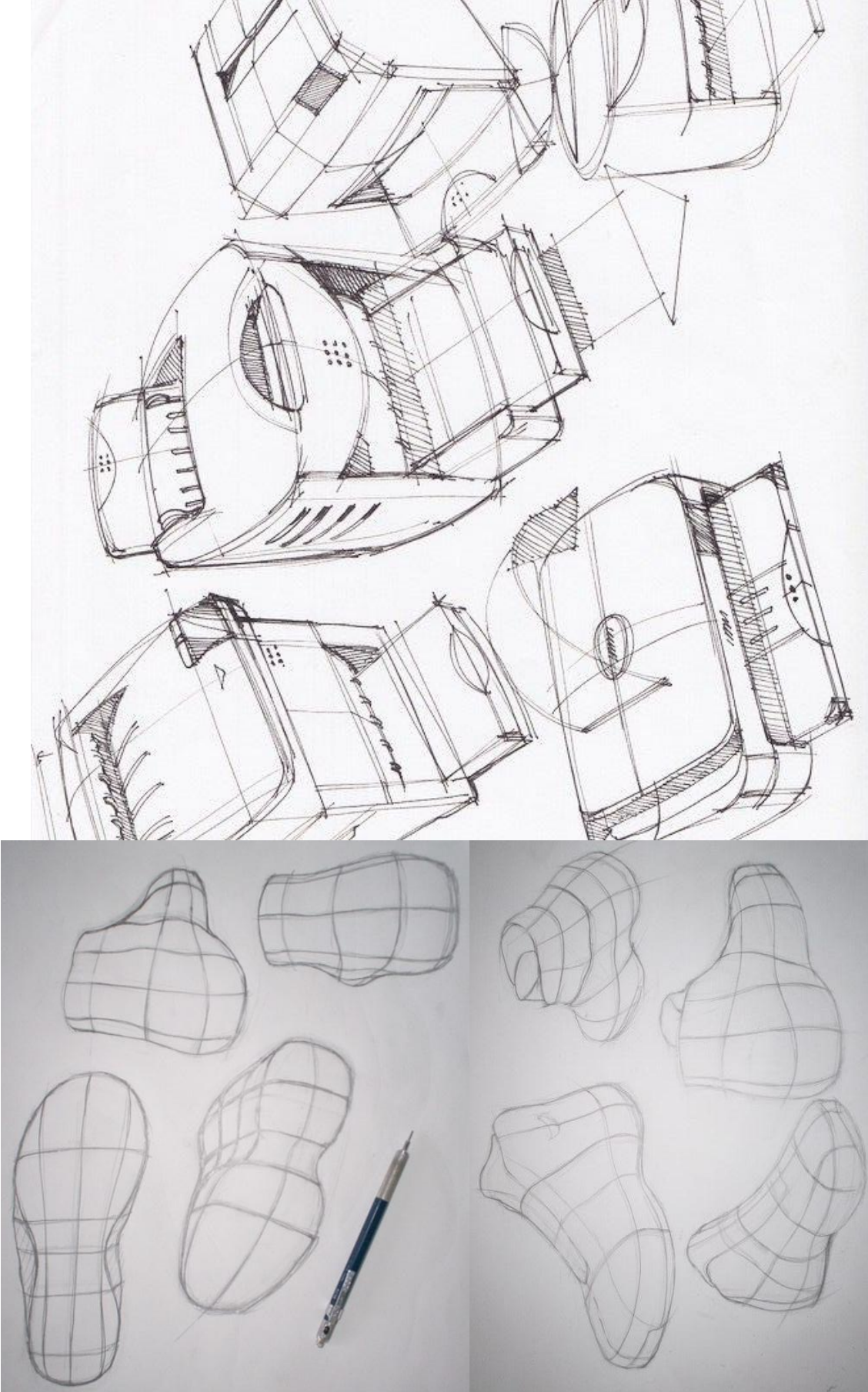

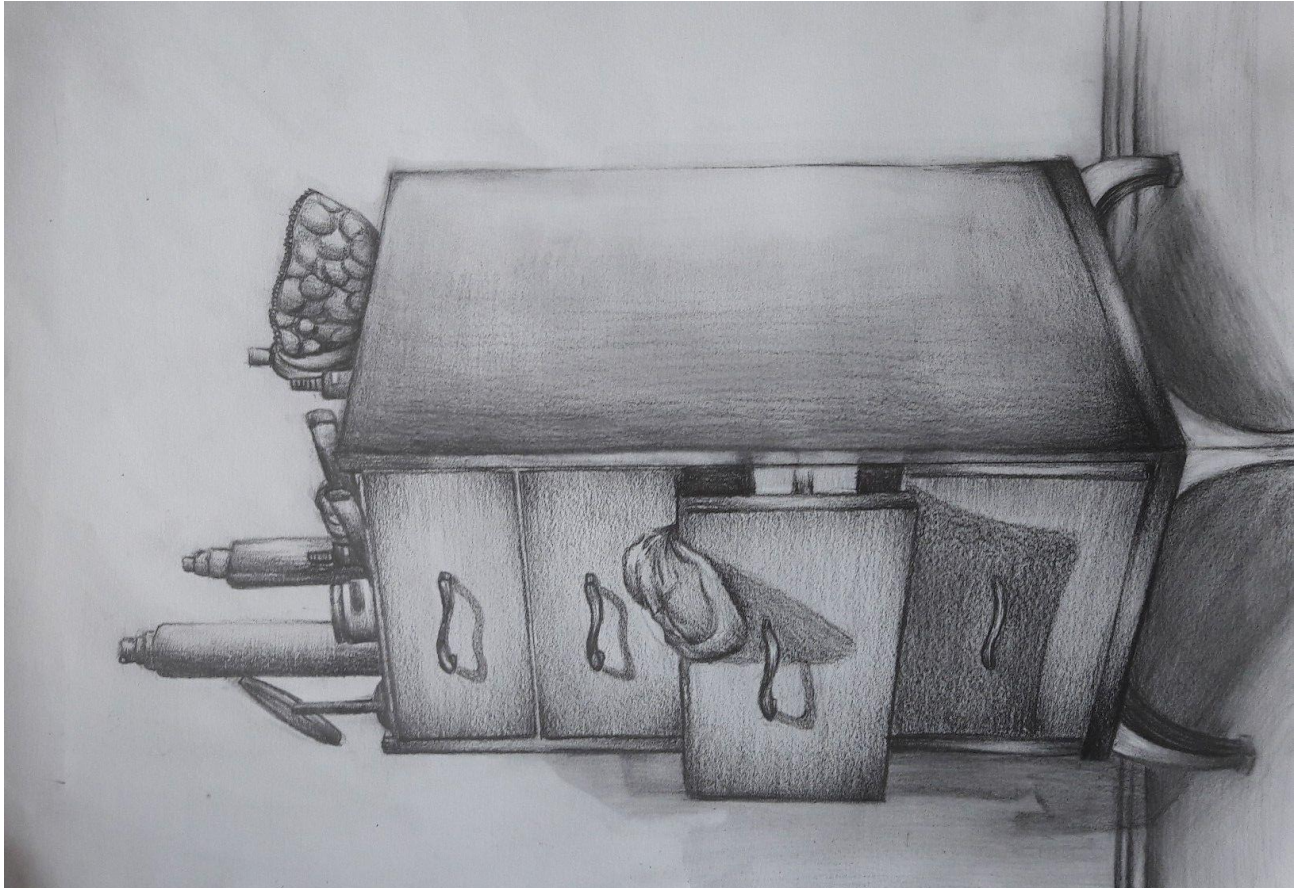
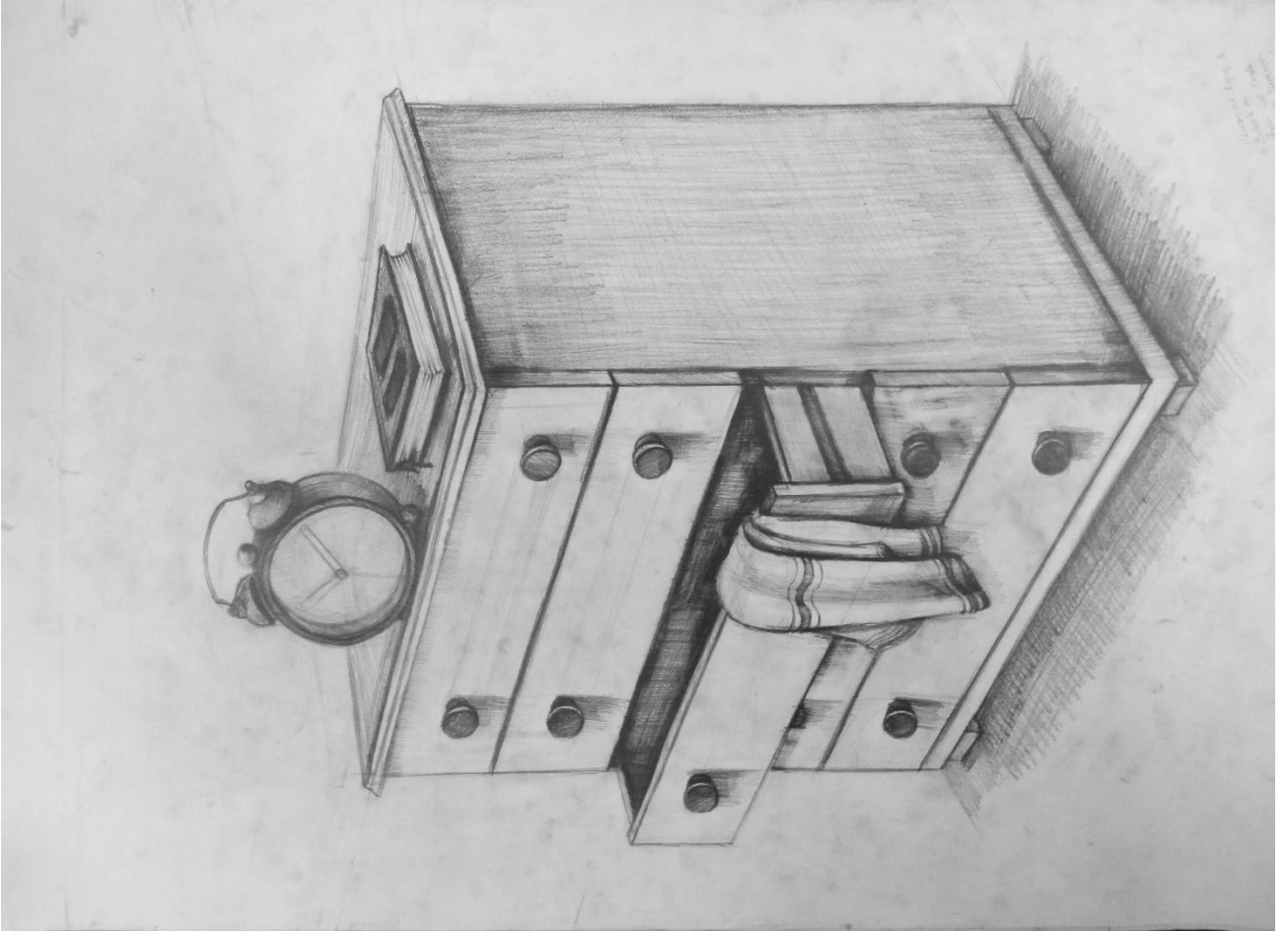



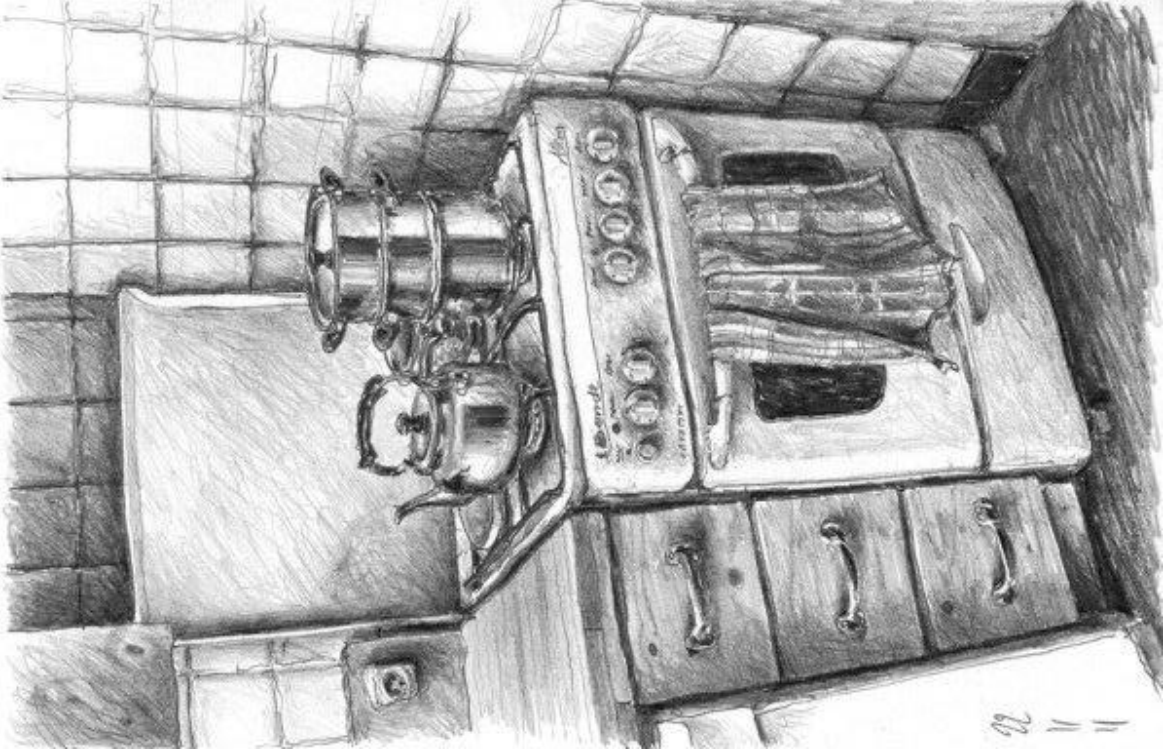
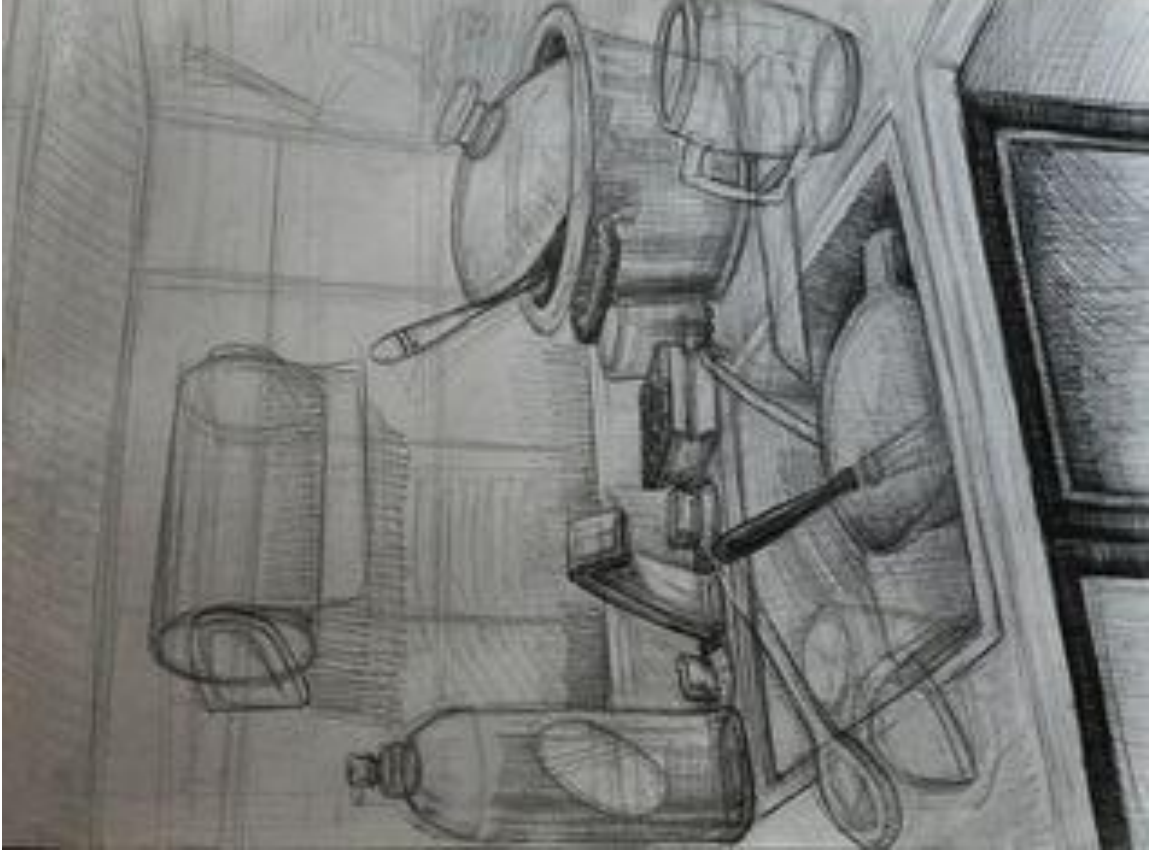

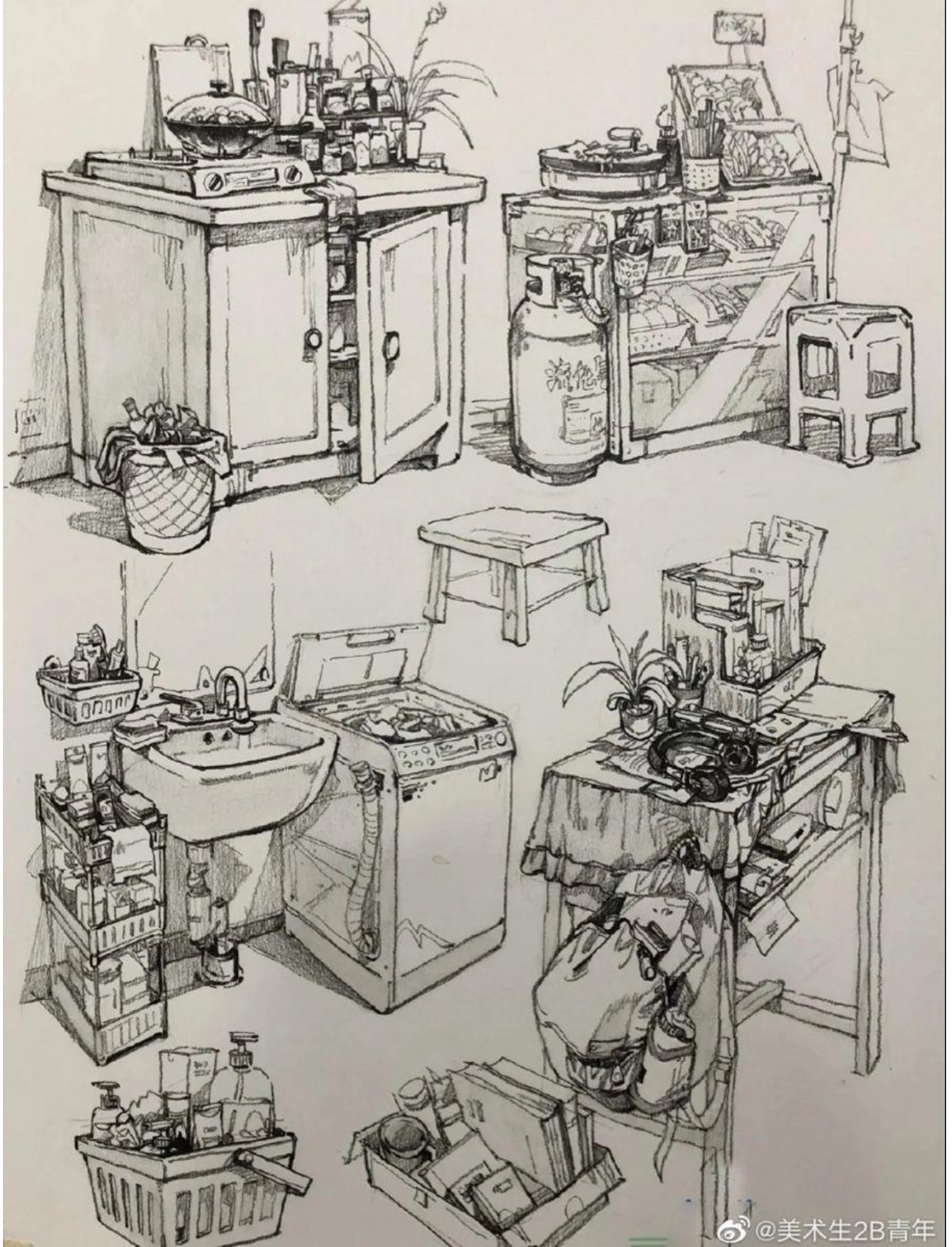









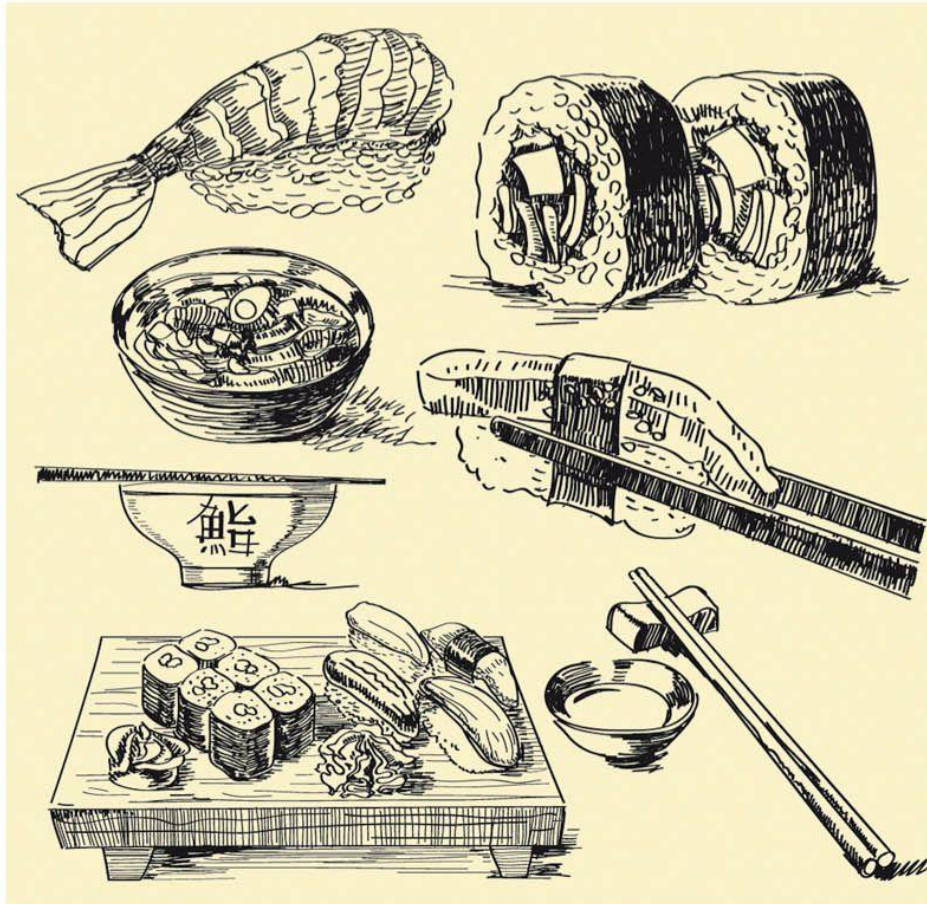
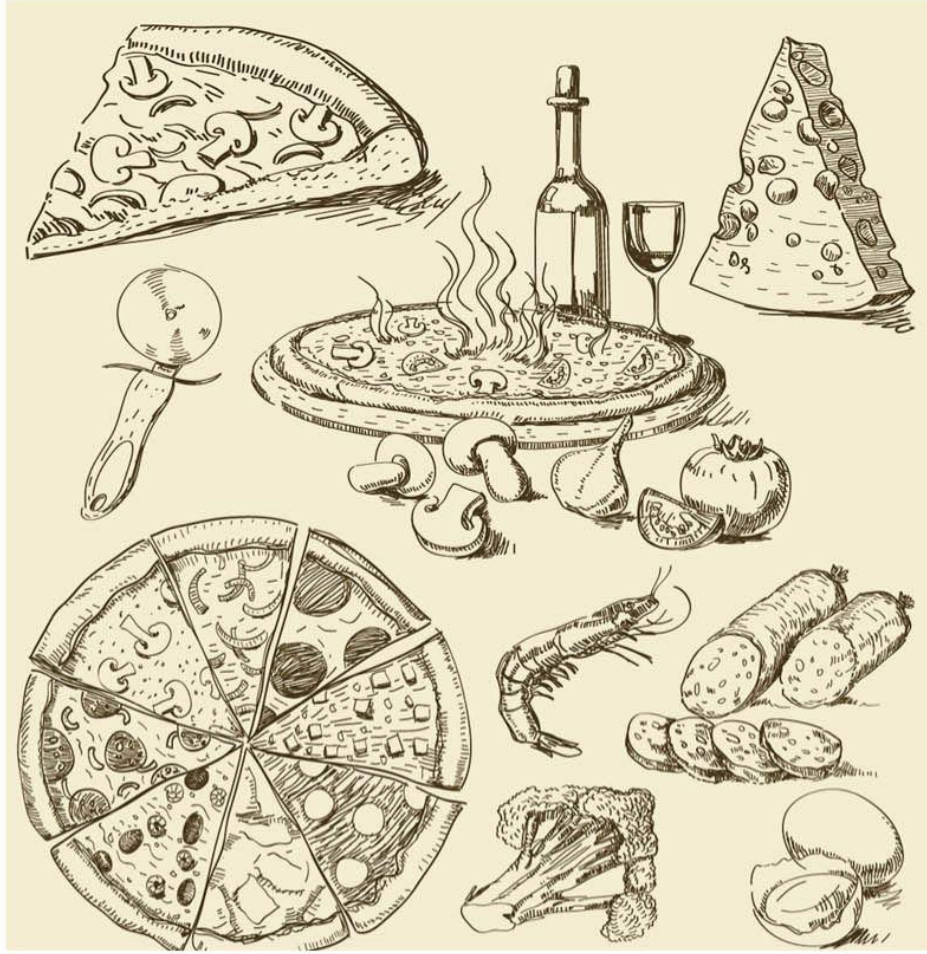

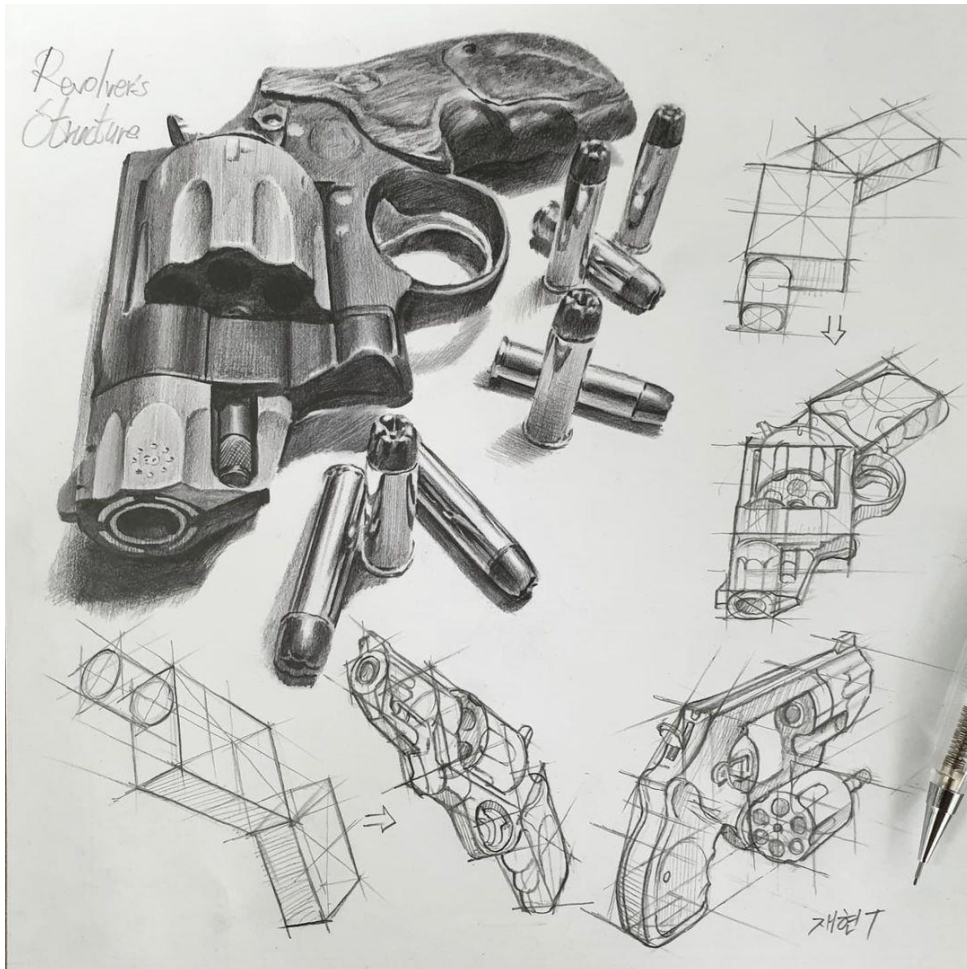
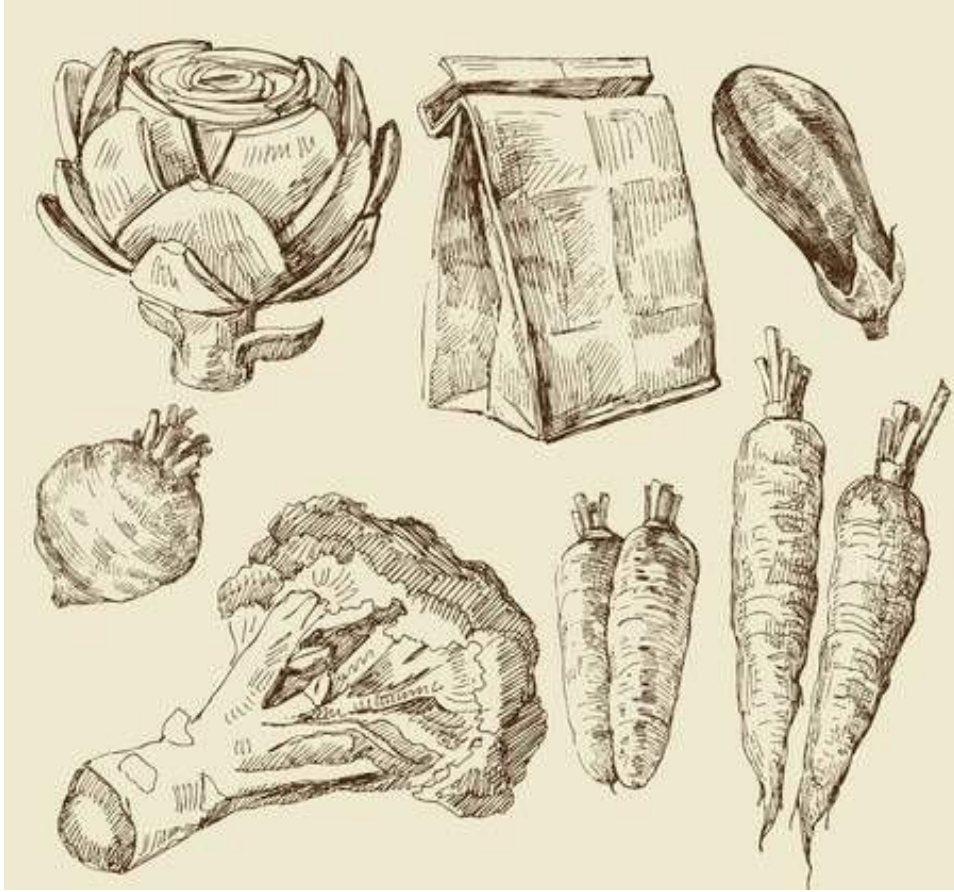





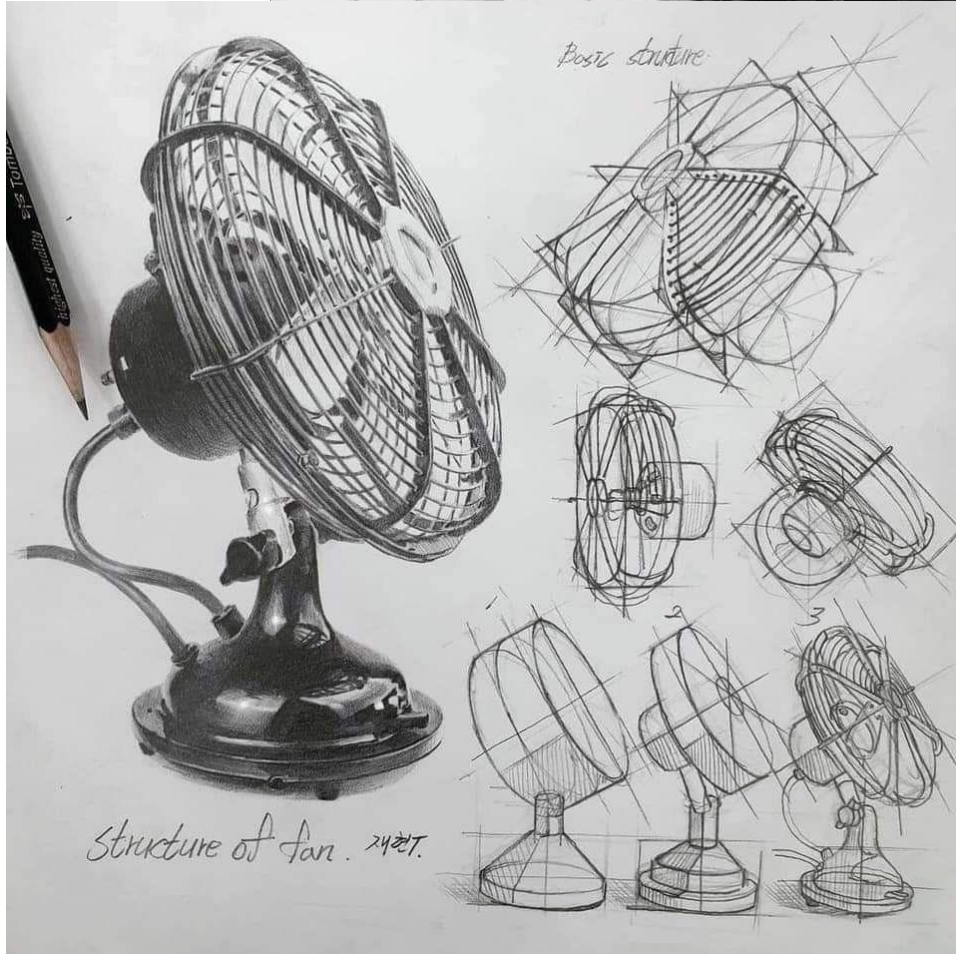

### Reupholstery Yardage Chart

Approximate Yardage Shown

Add 2 yards if button tufting. Add 1 1/2 (1.5) yards if skirt for sofa. Add 3/4 (.75) yards if skirt for chair.



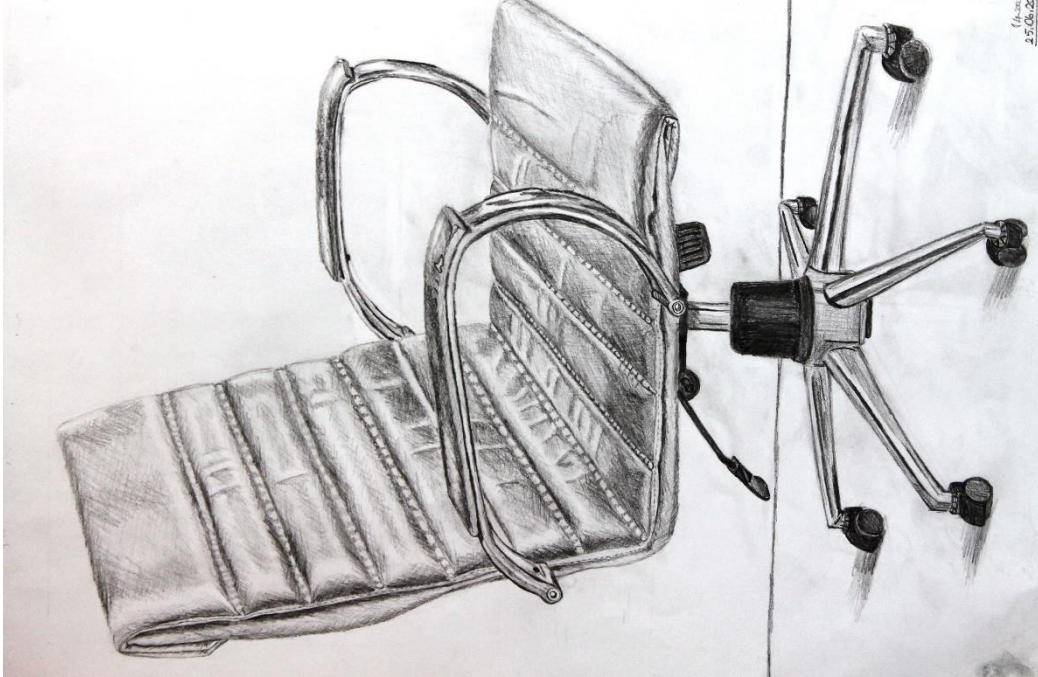
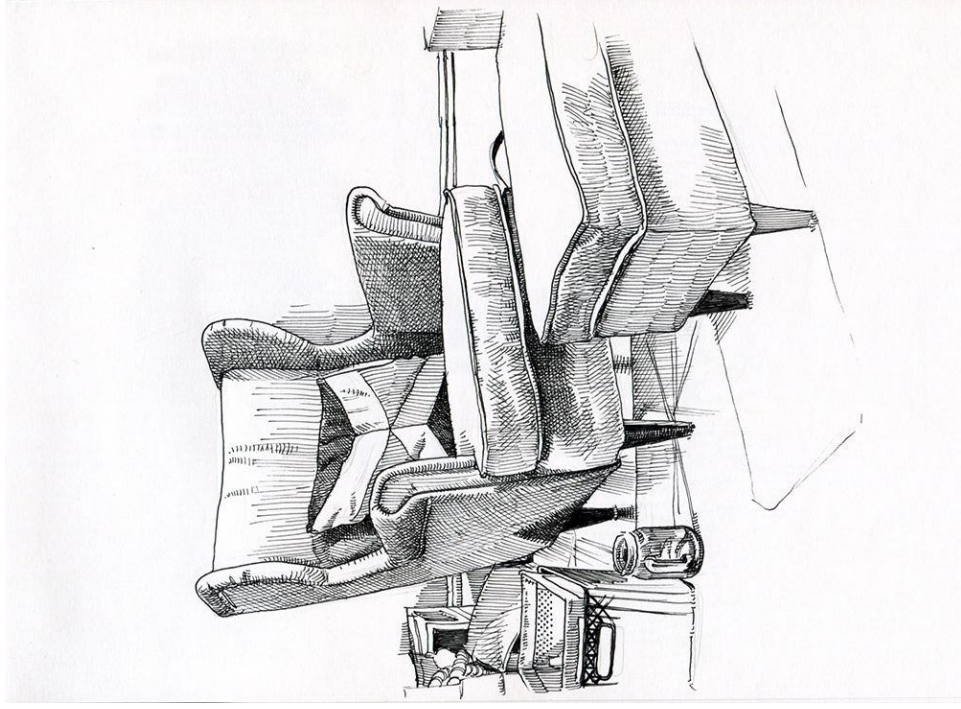

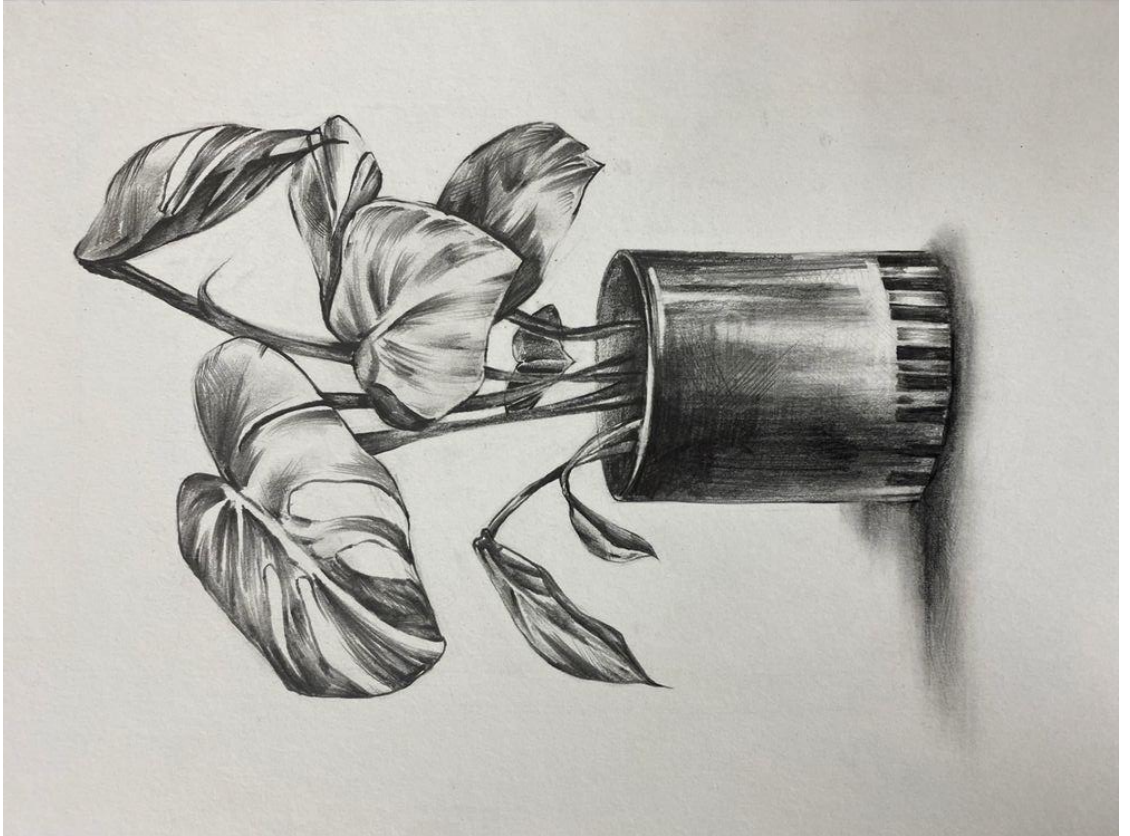
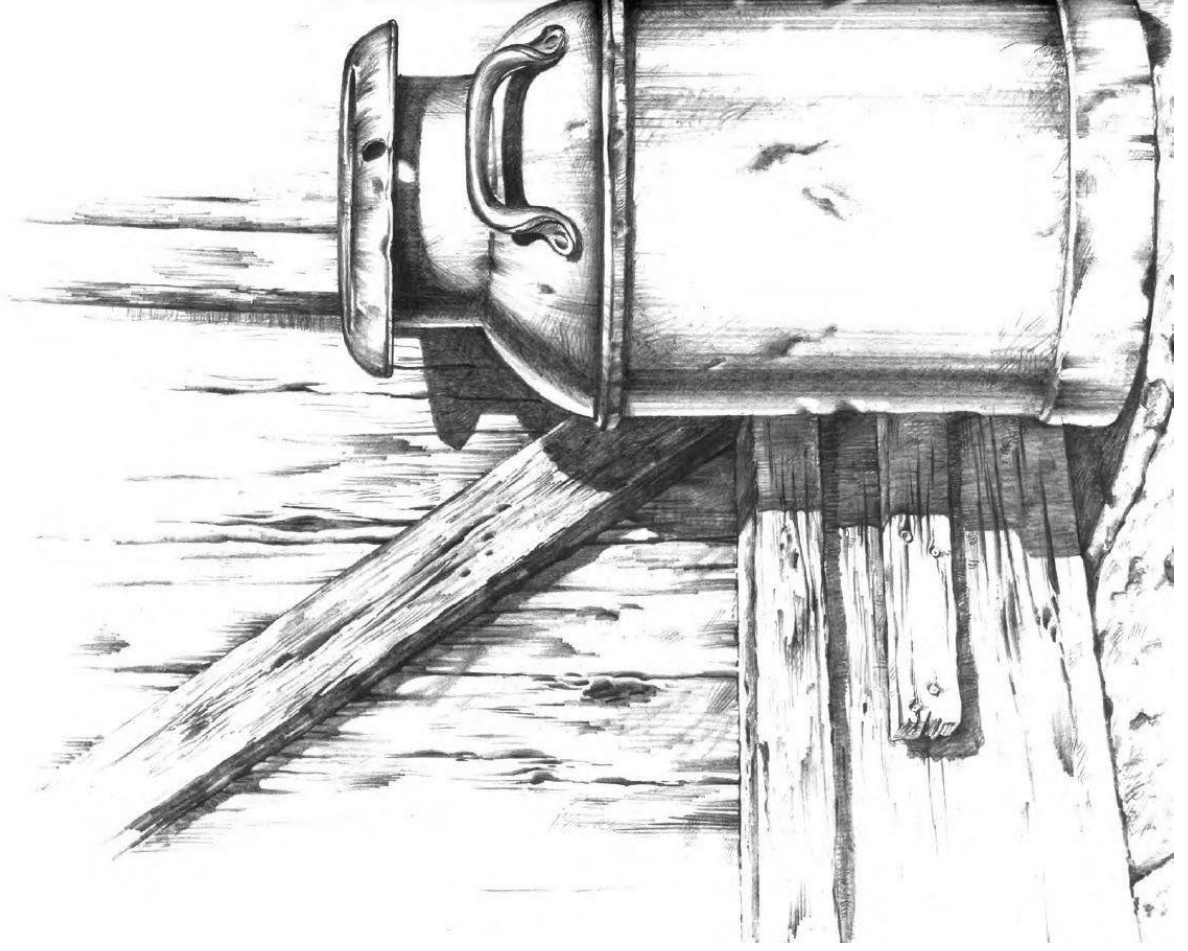

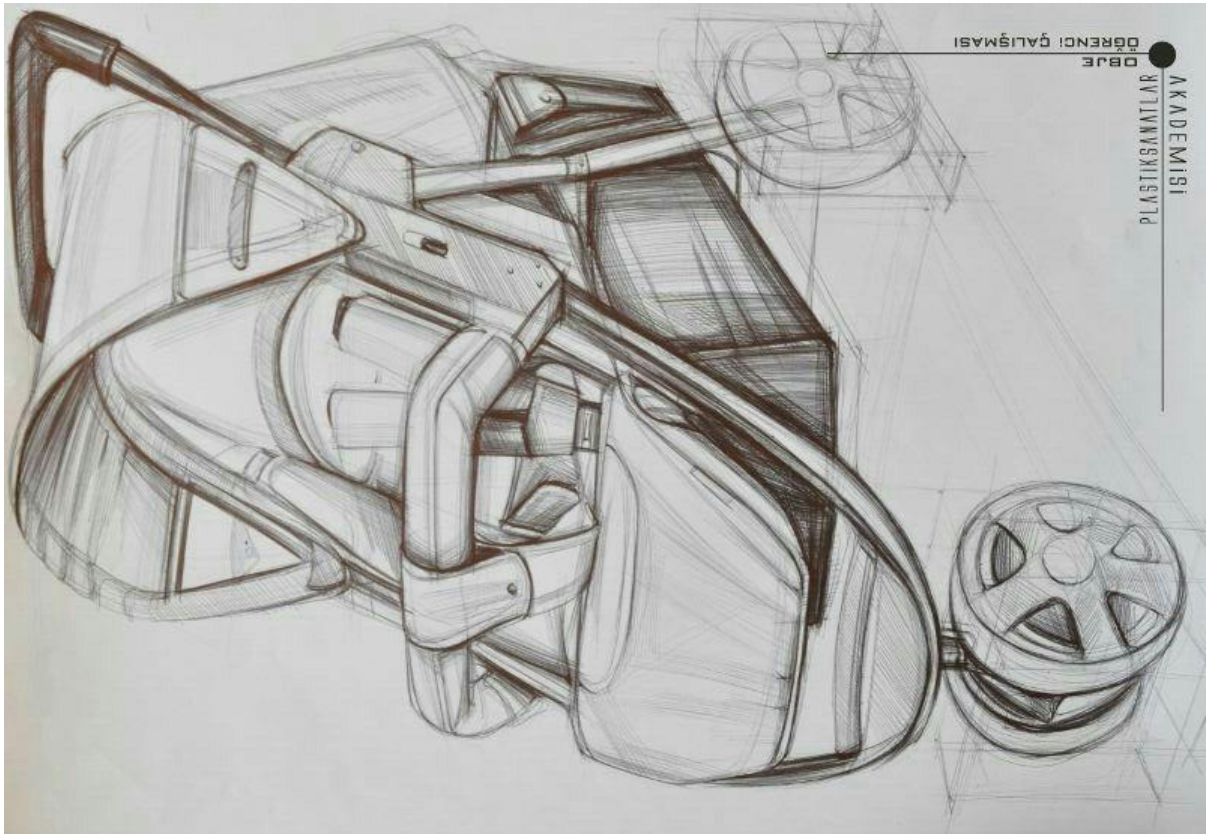

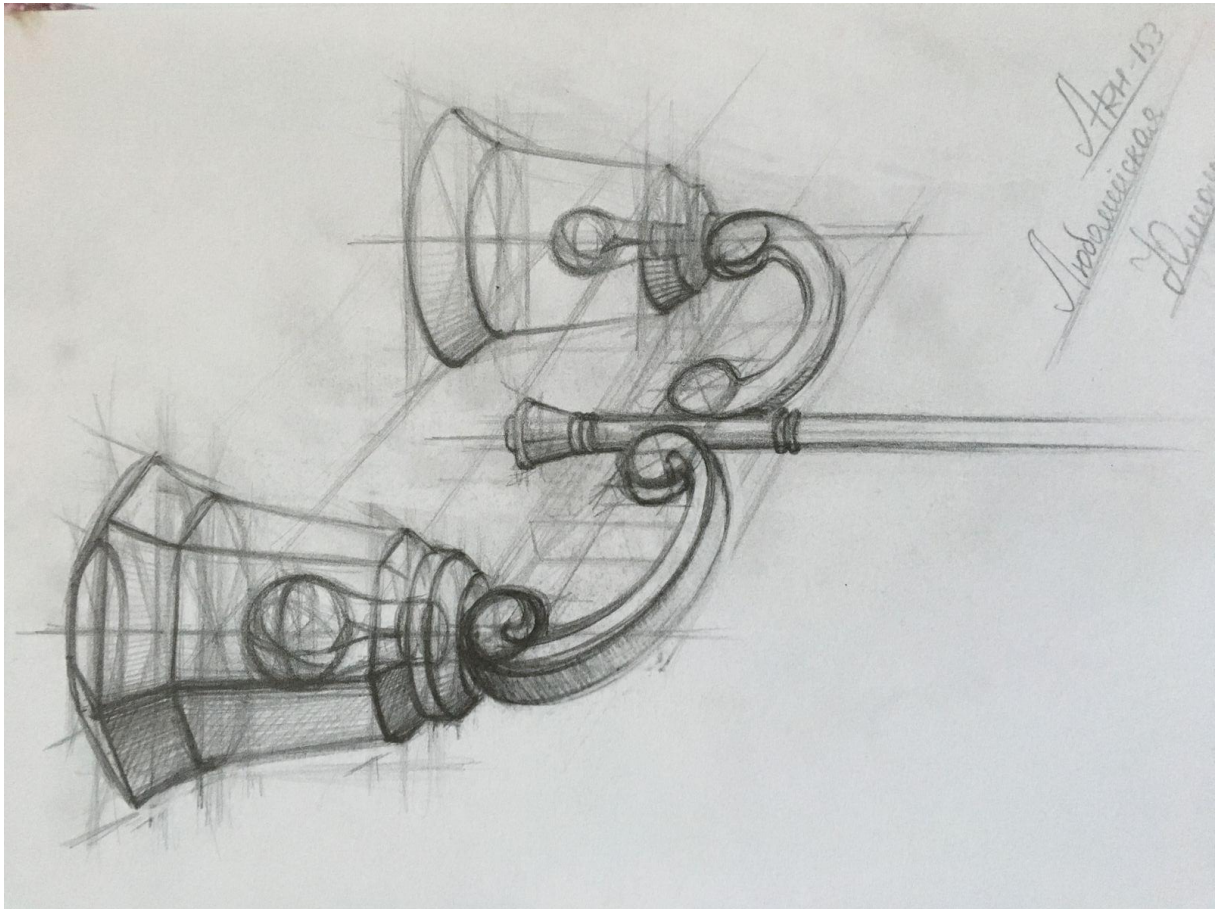
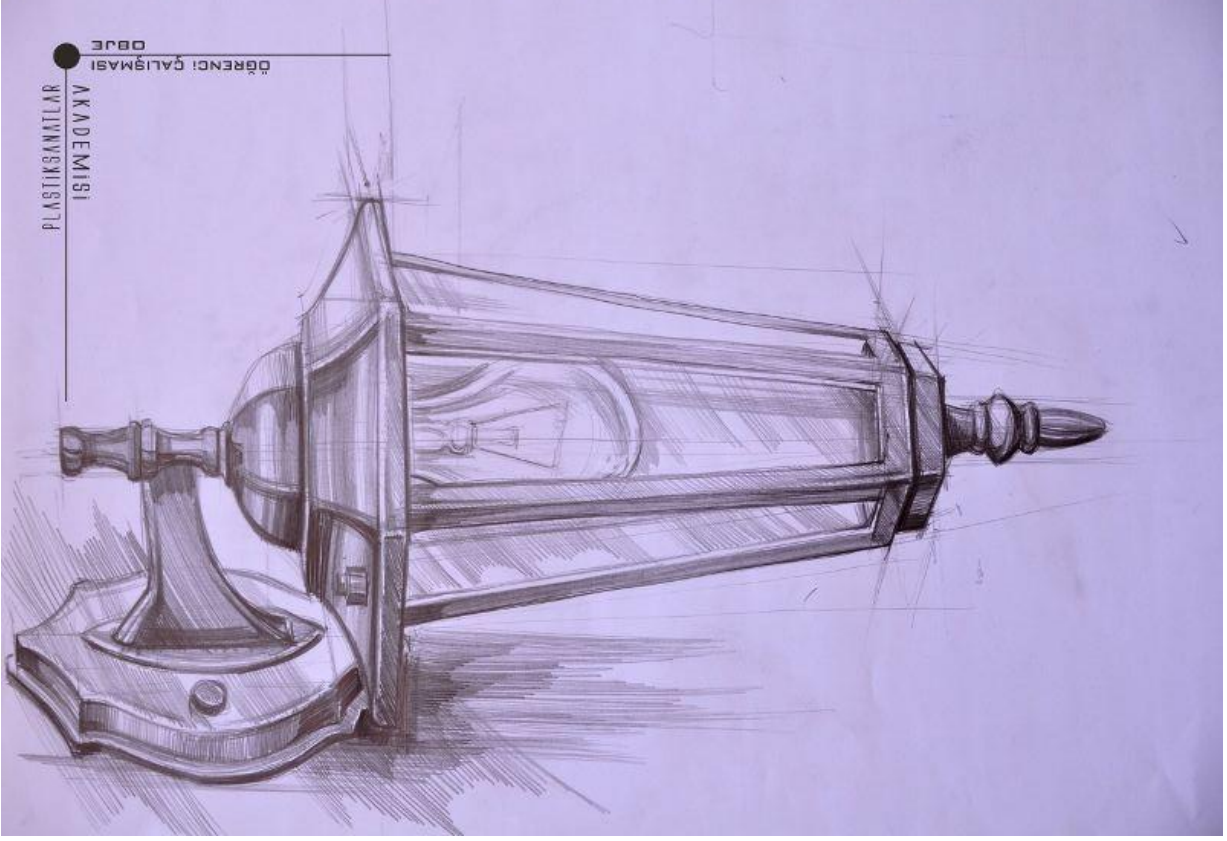

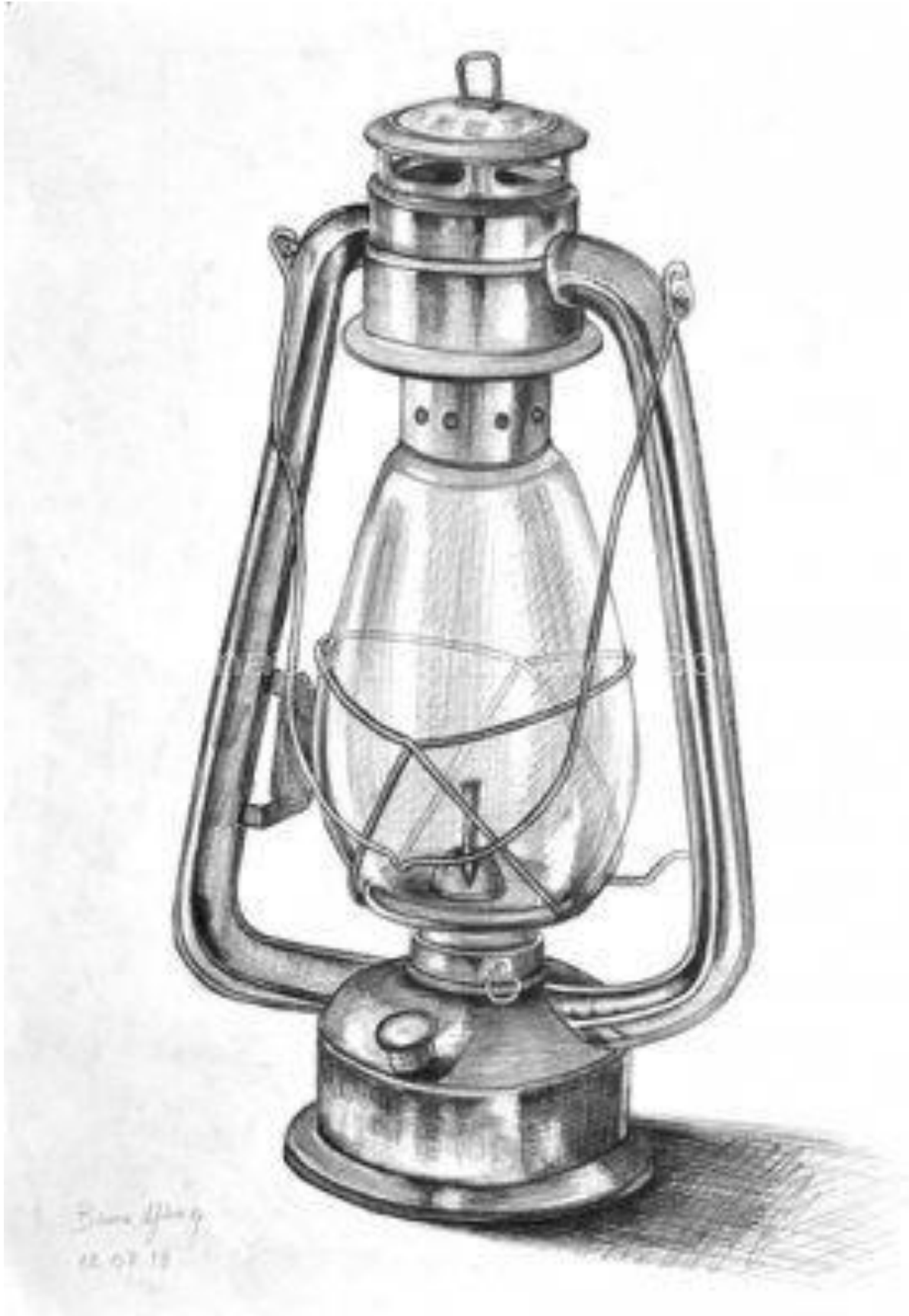



## HAYVAN FIGÜRÜ ÇİZİMLERİ

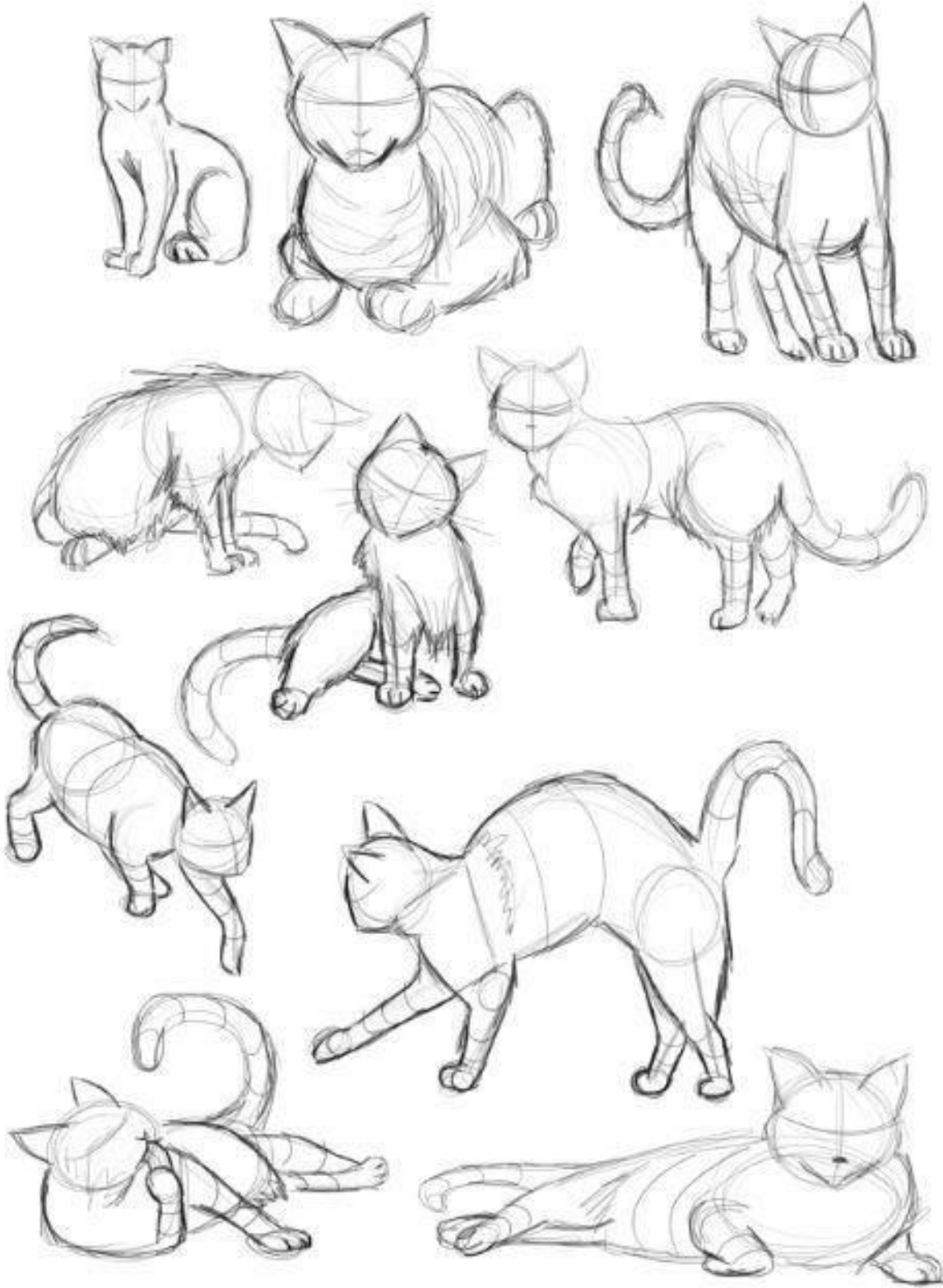

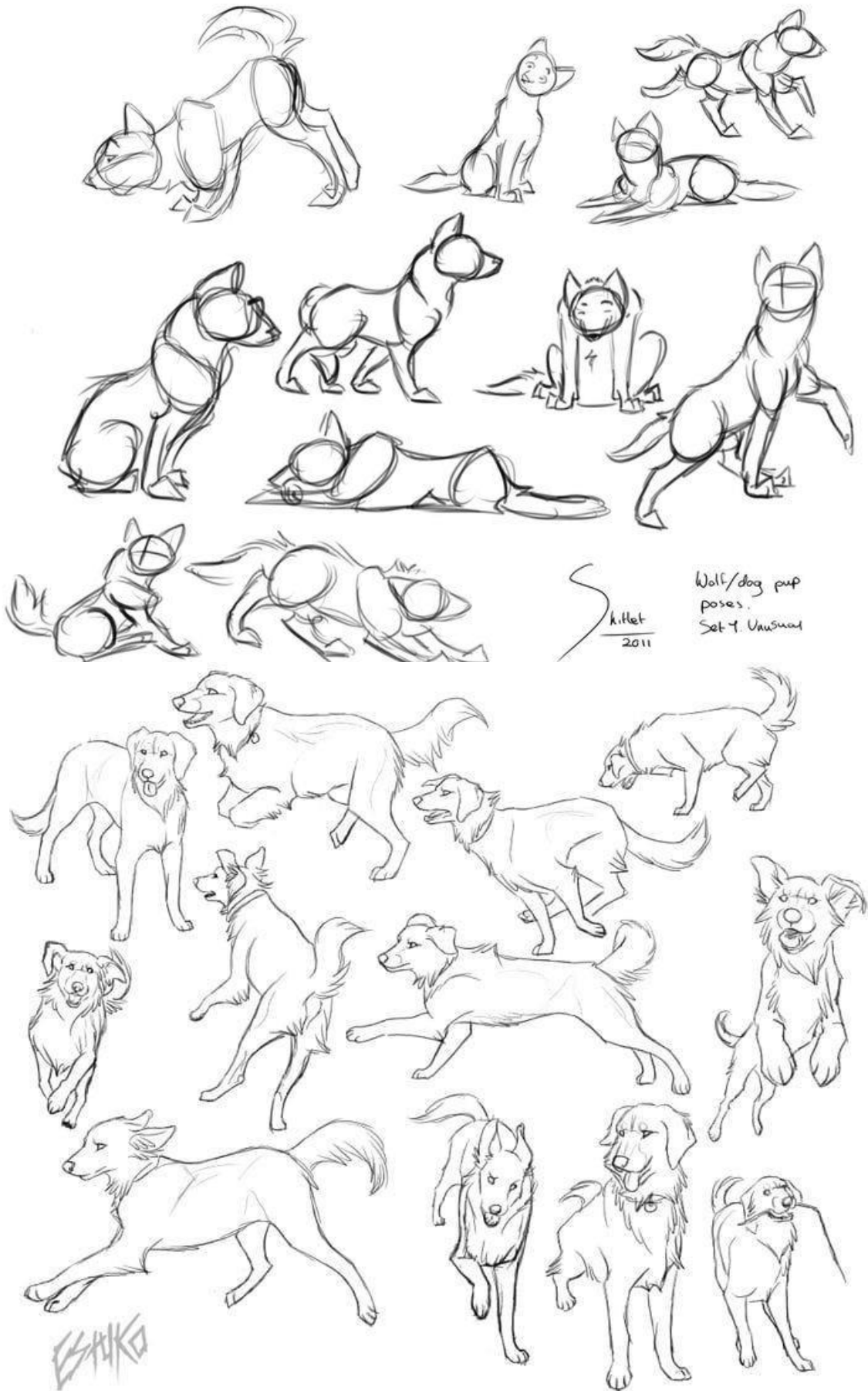

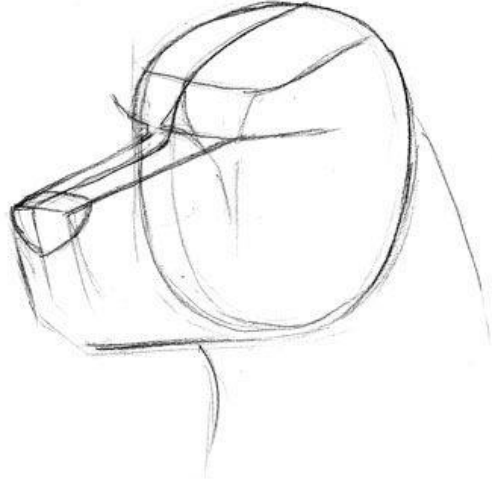
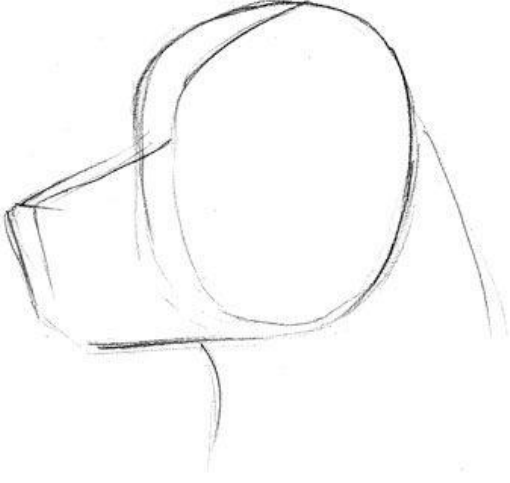

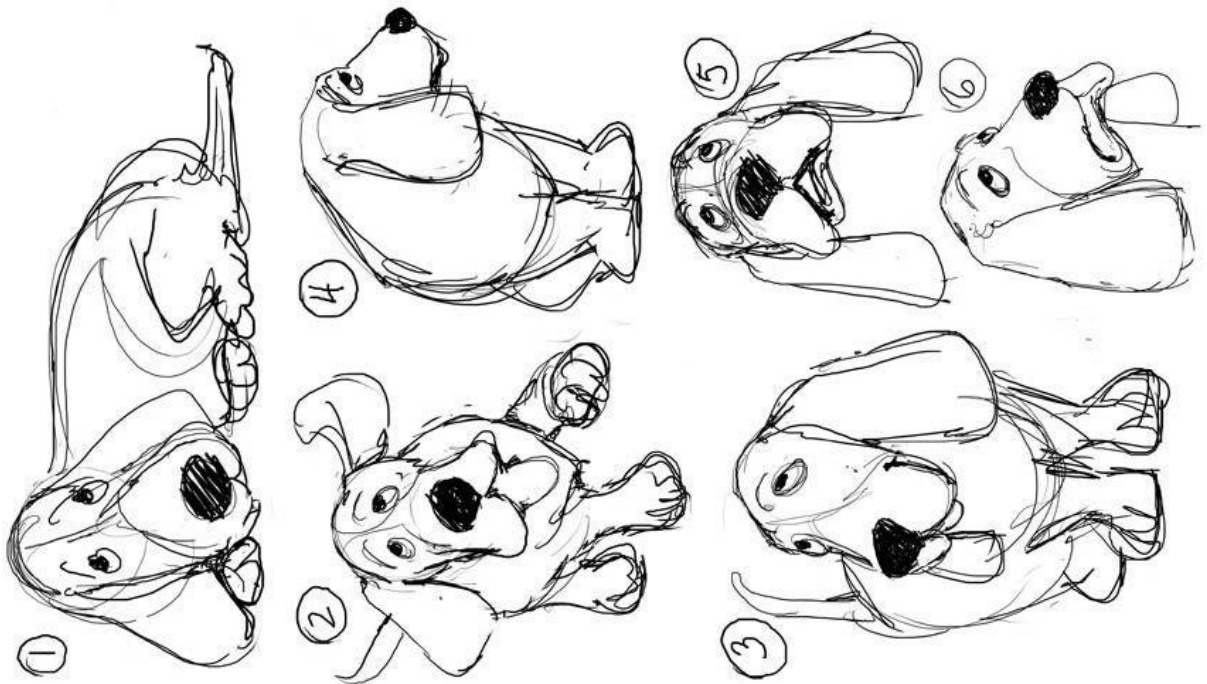
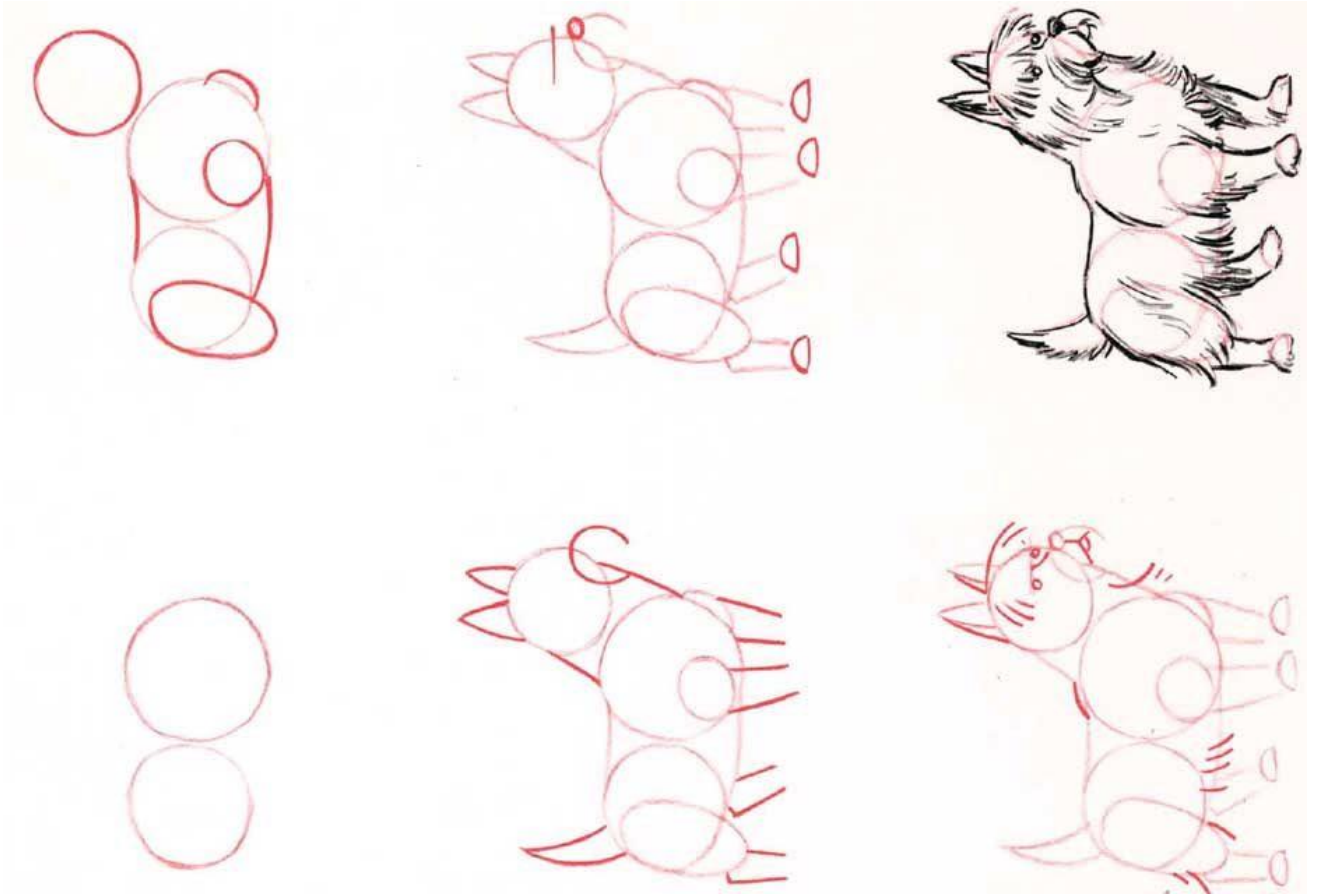

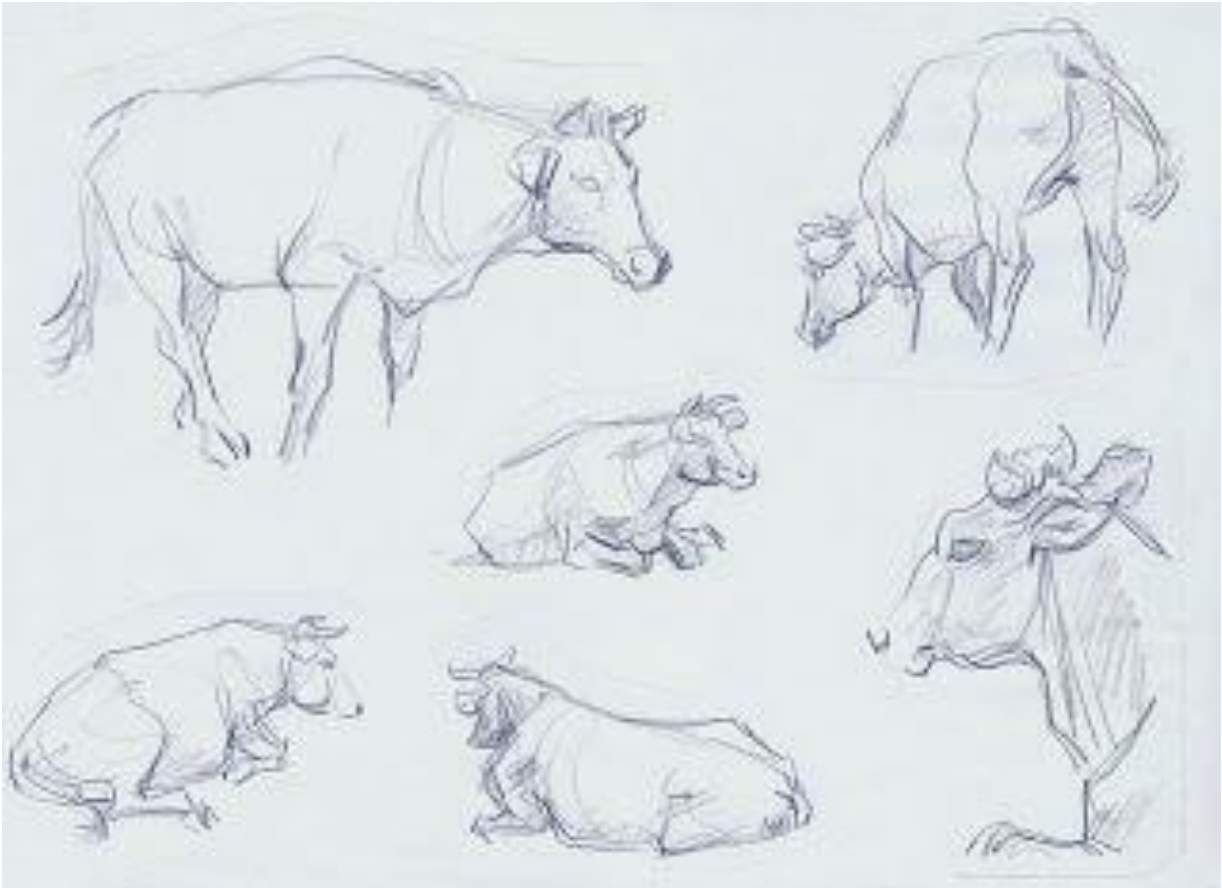
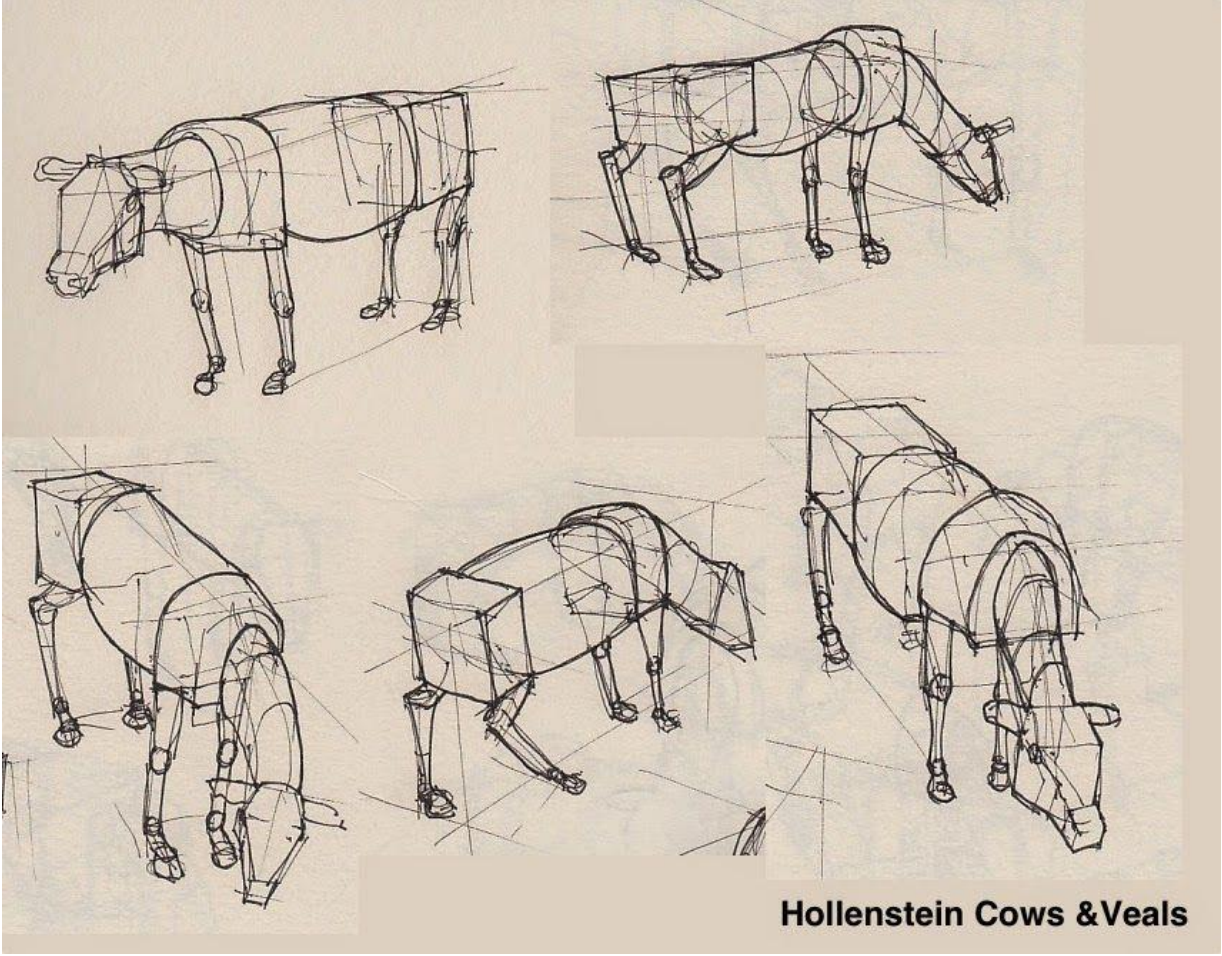

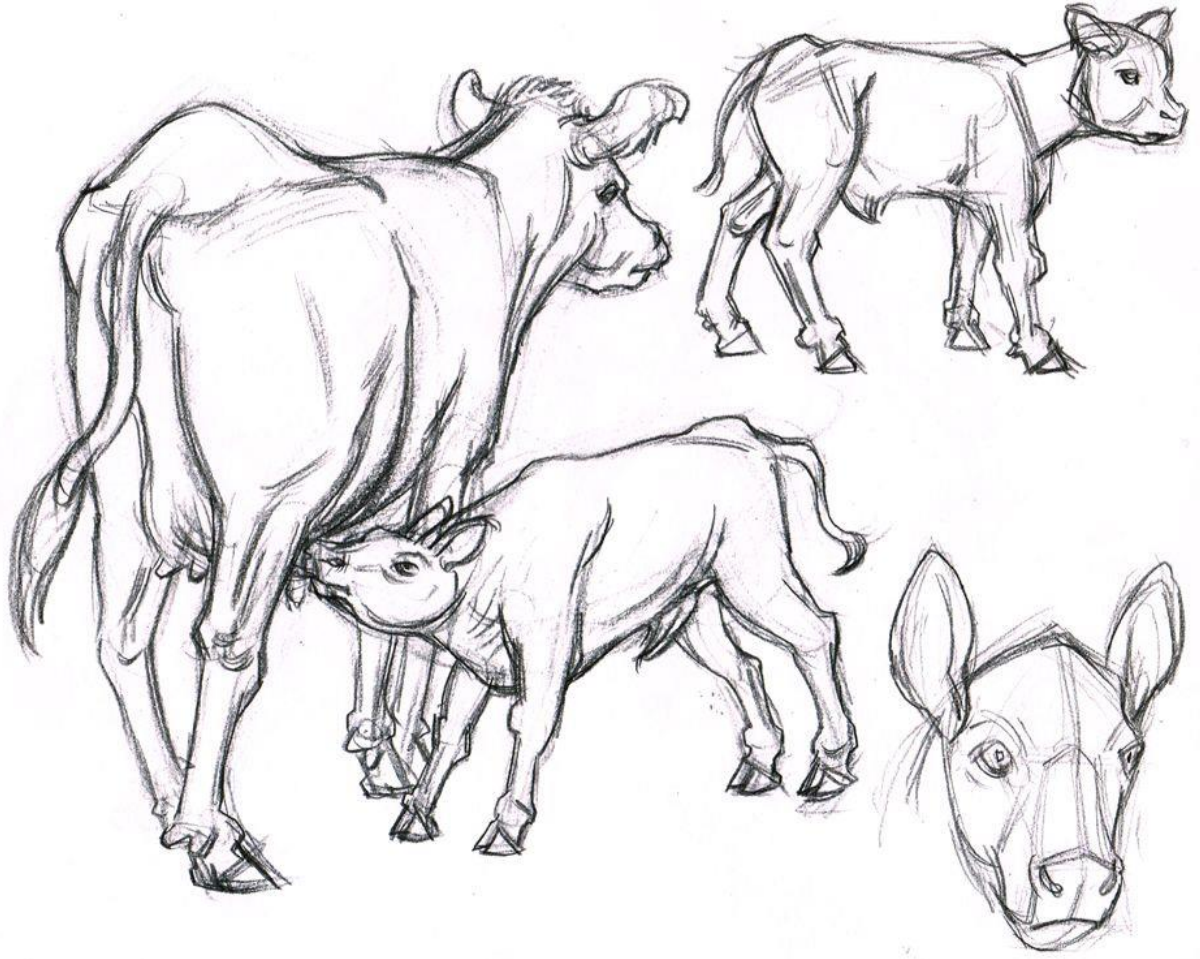

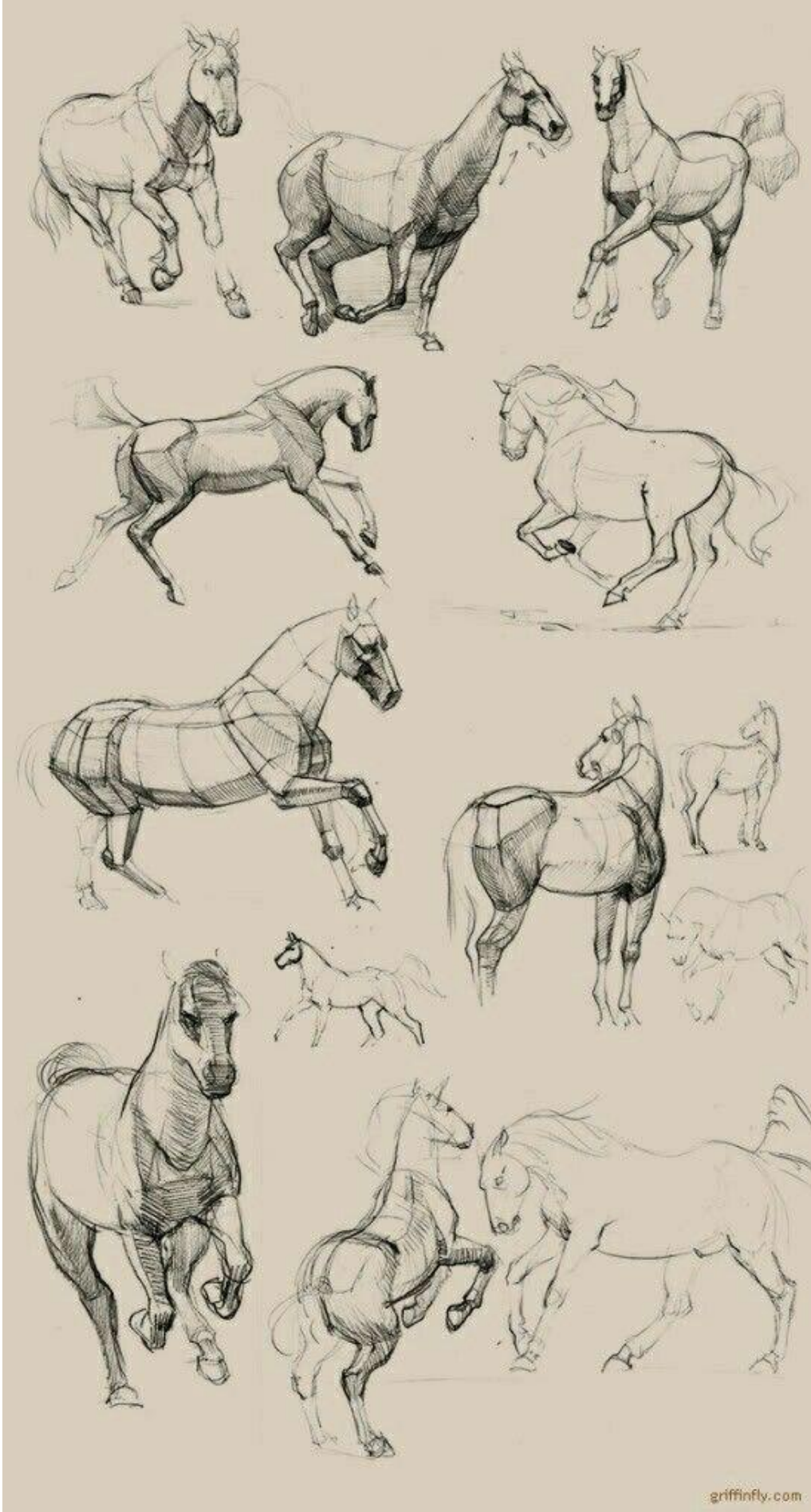

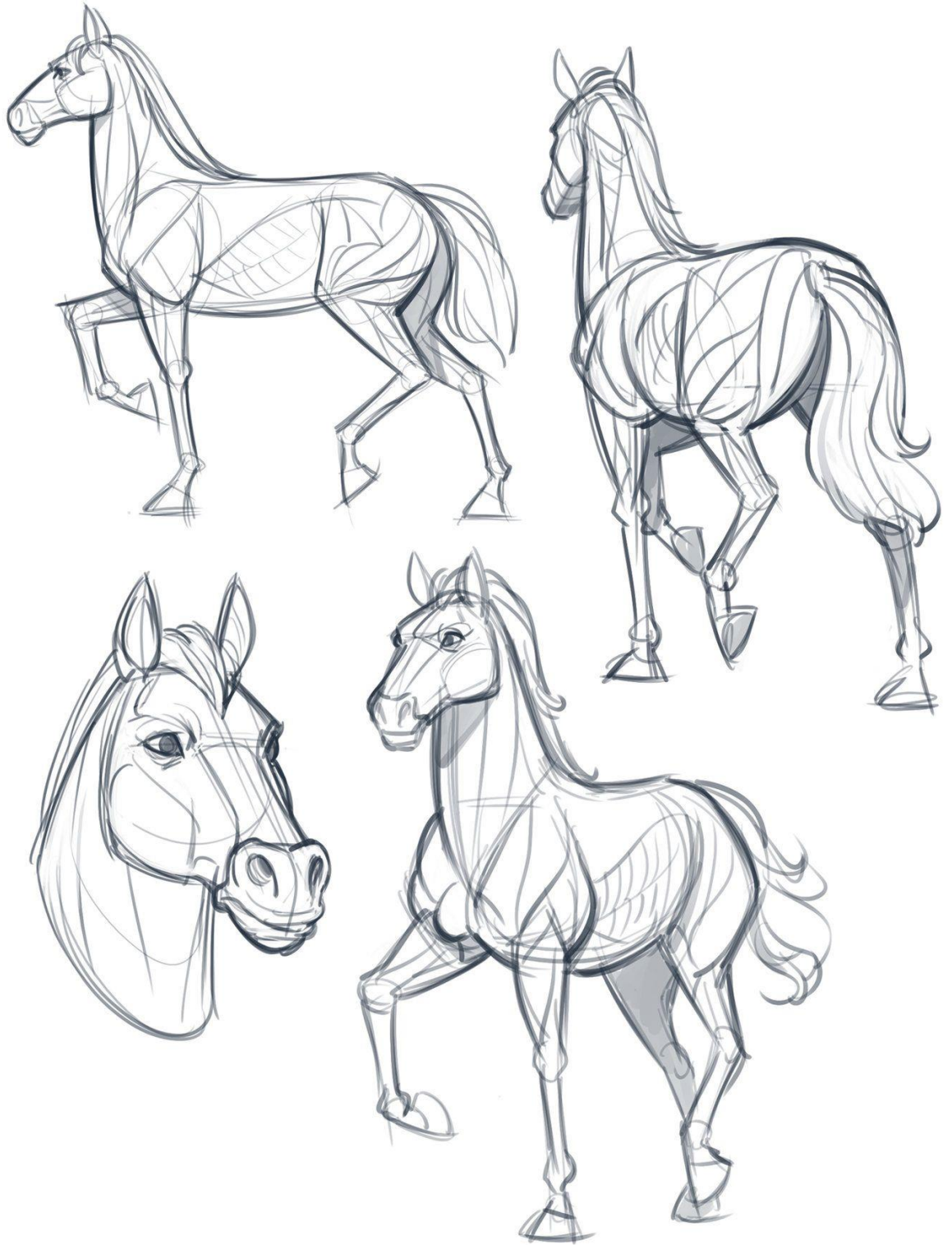



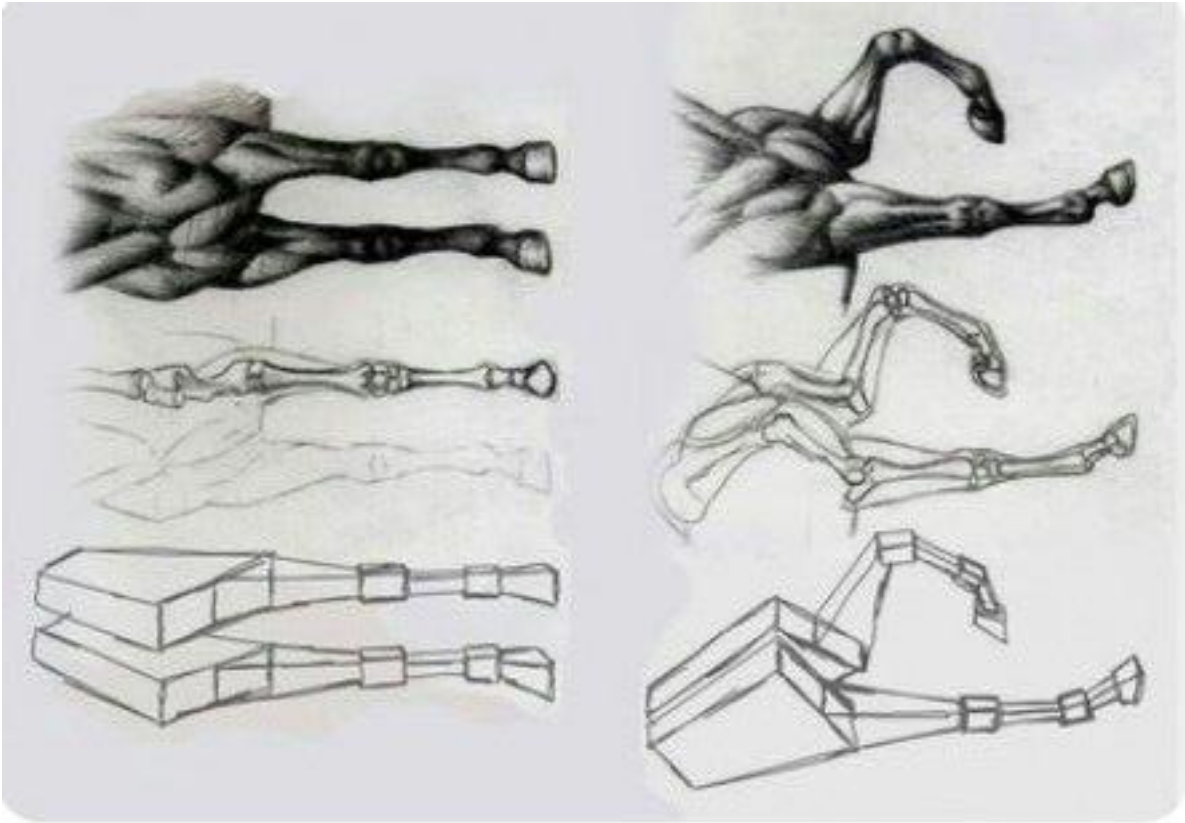



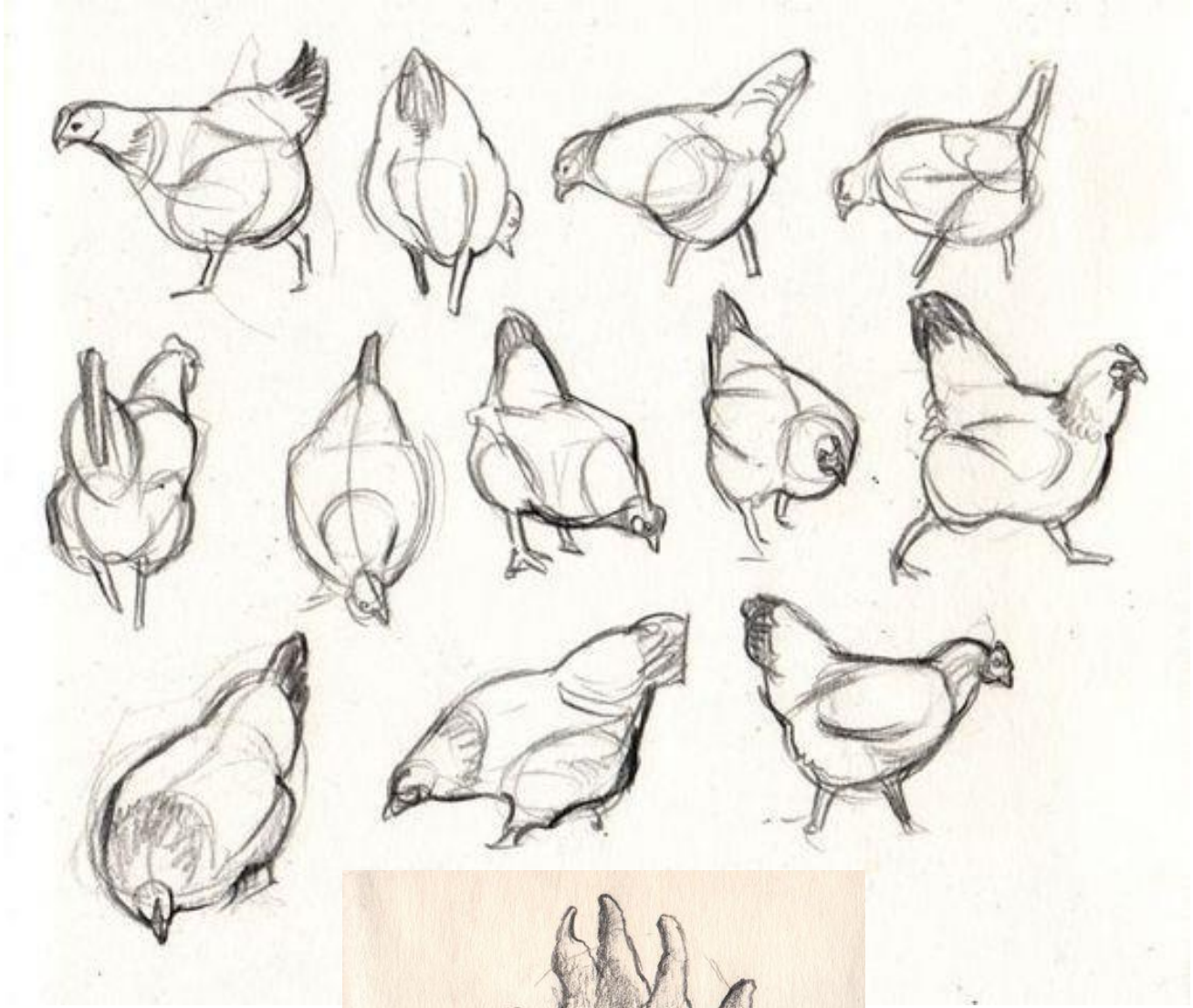



artwork by Bianca Siercke

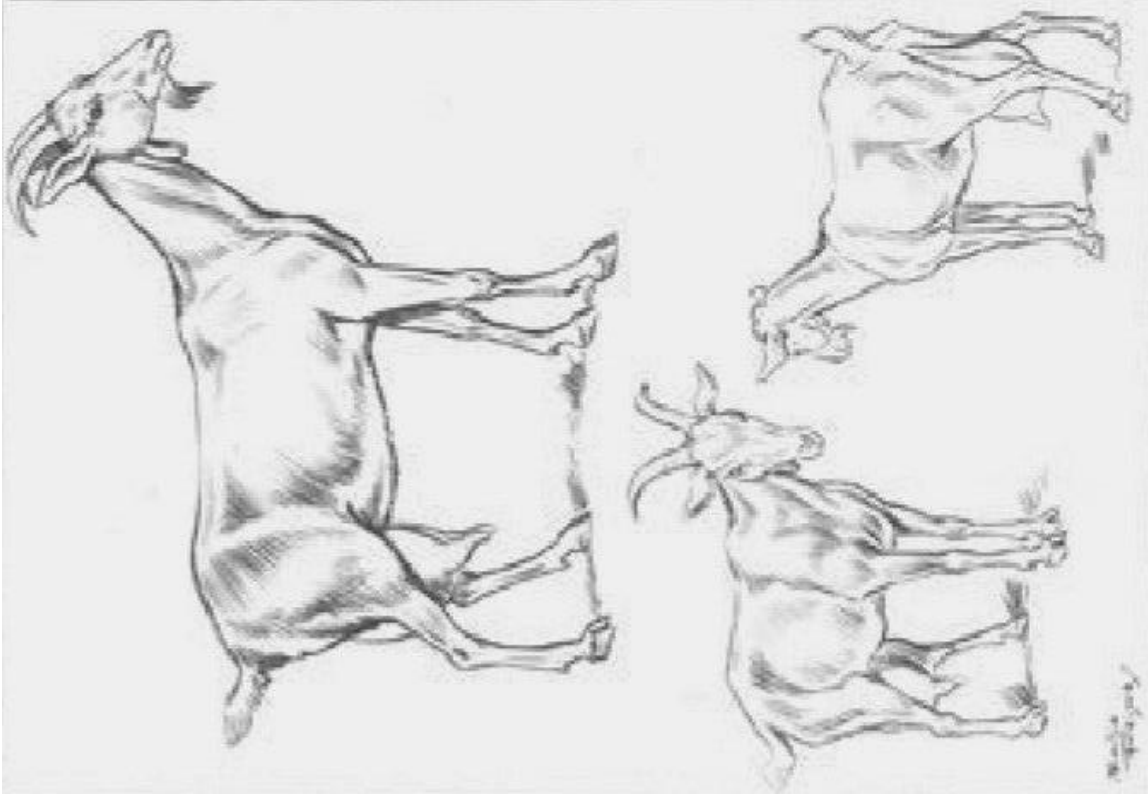

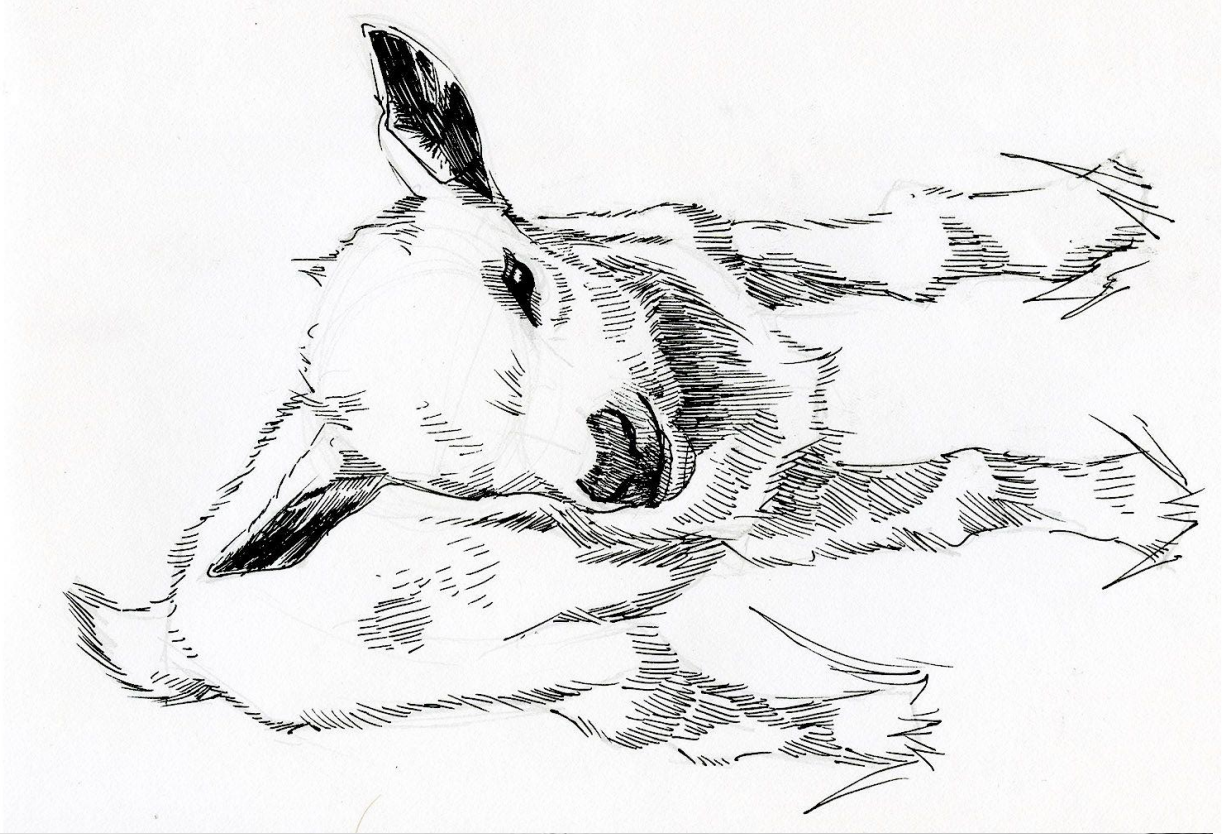

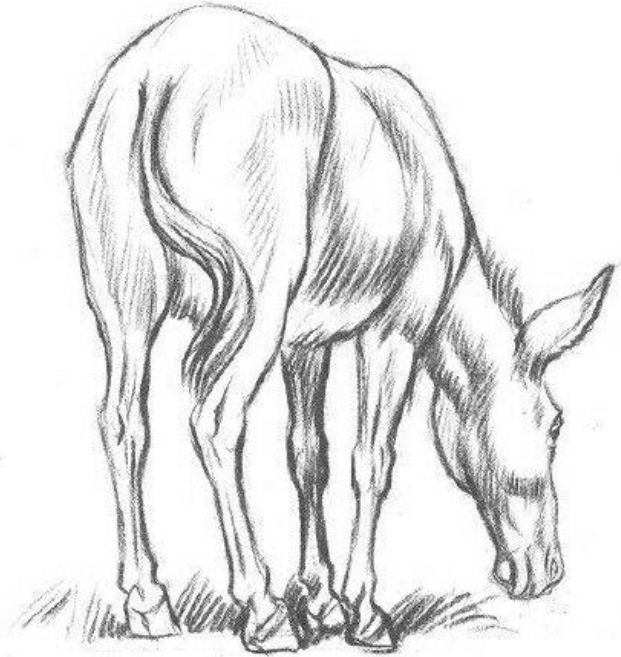
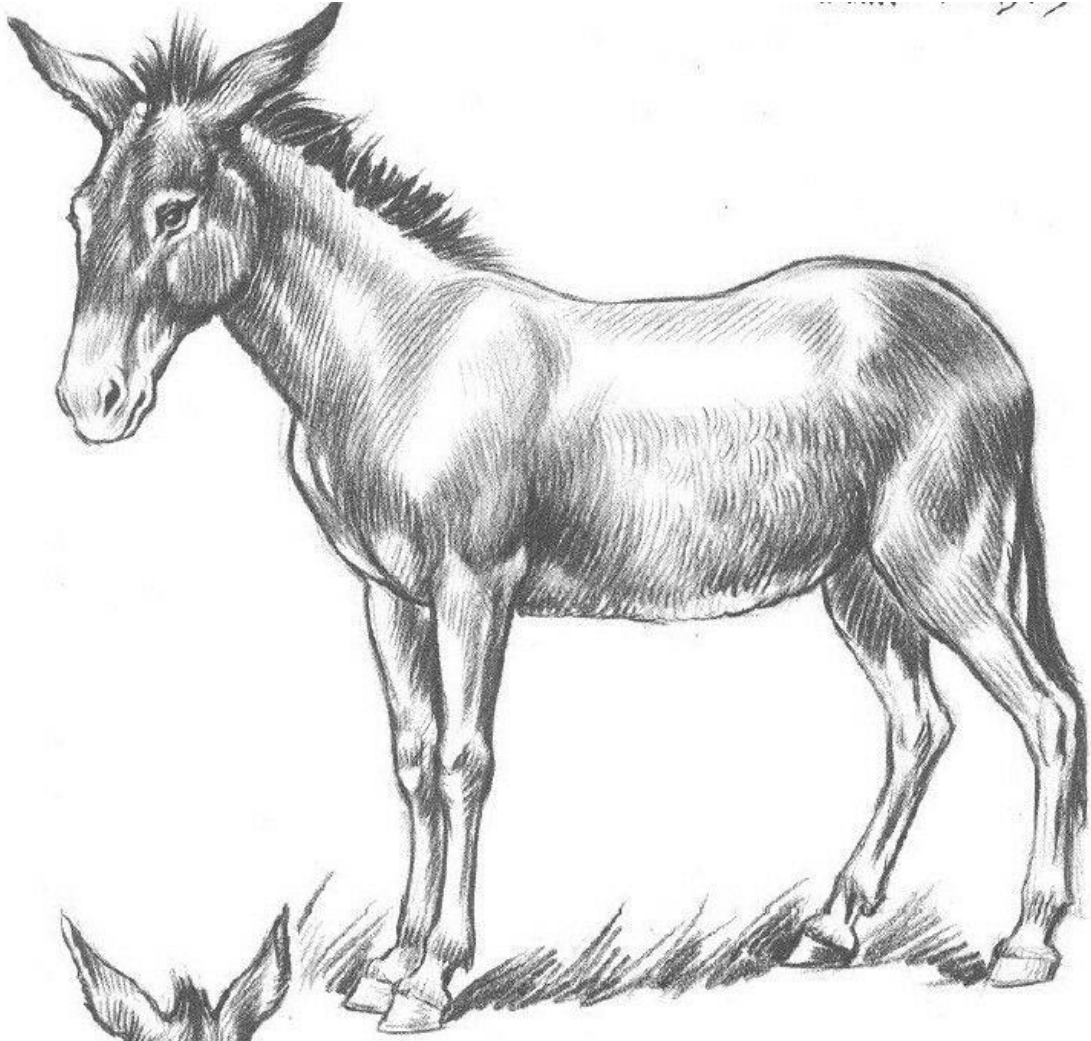

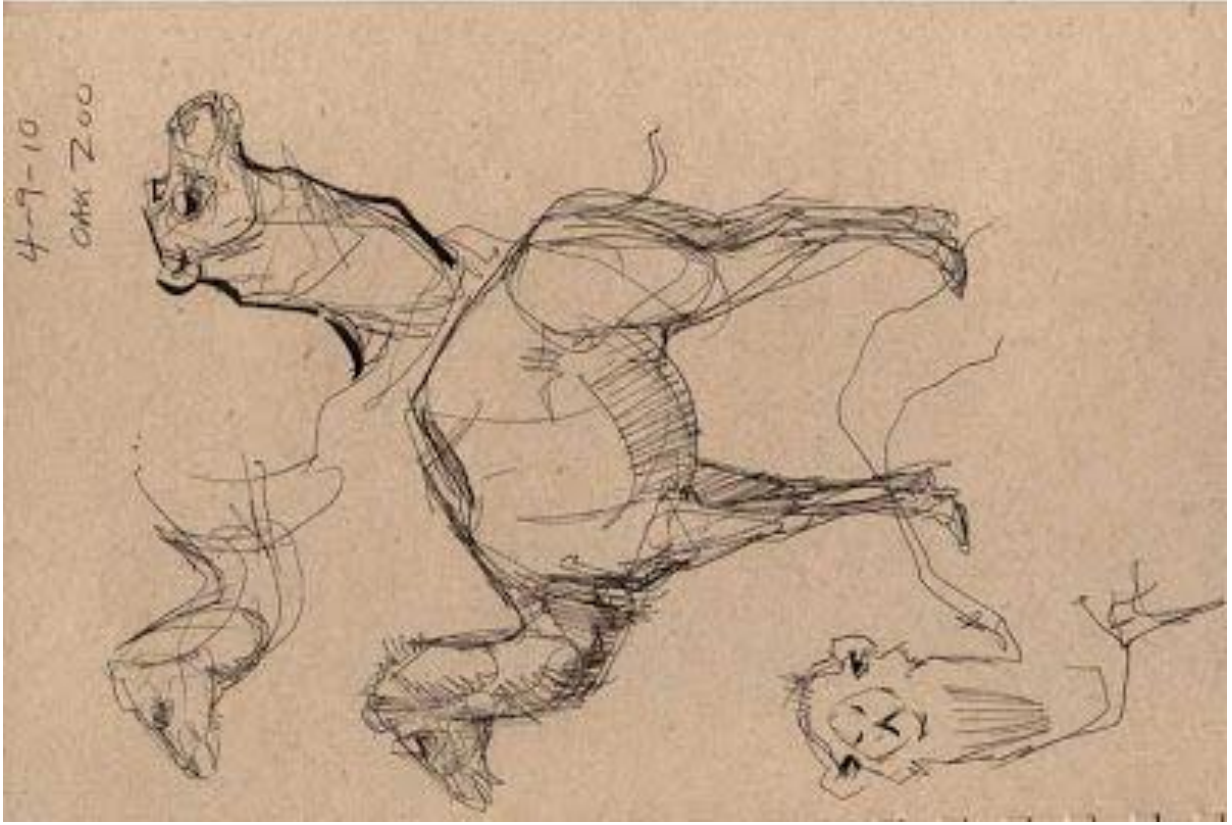





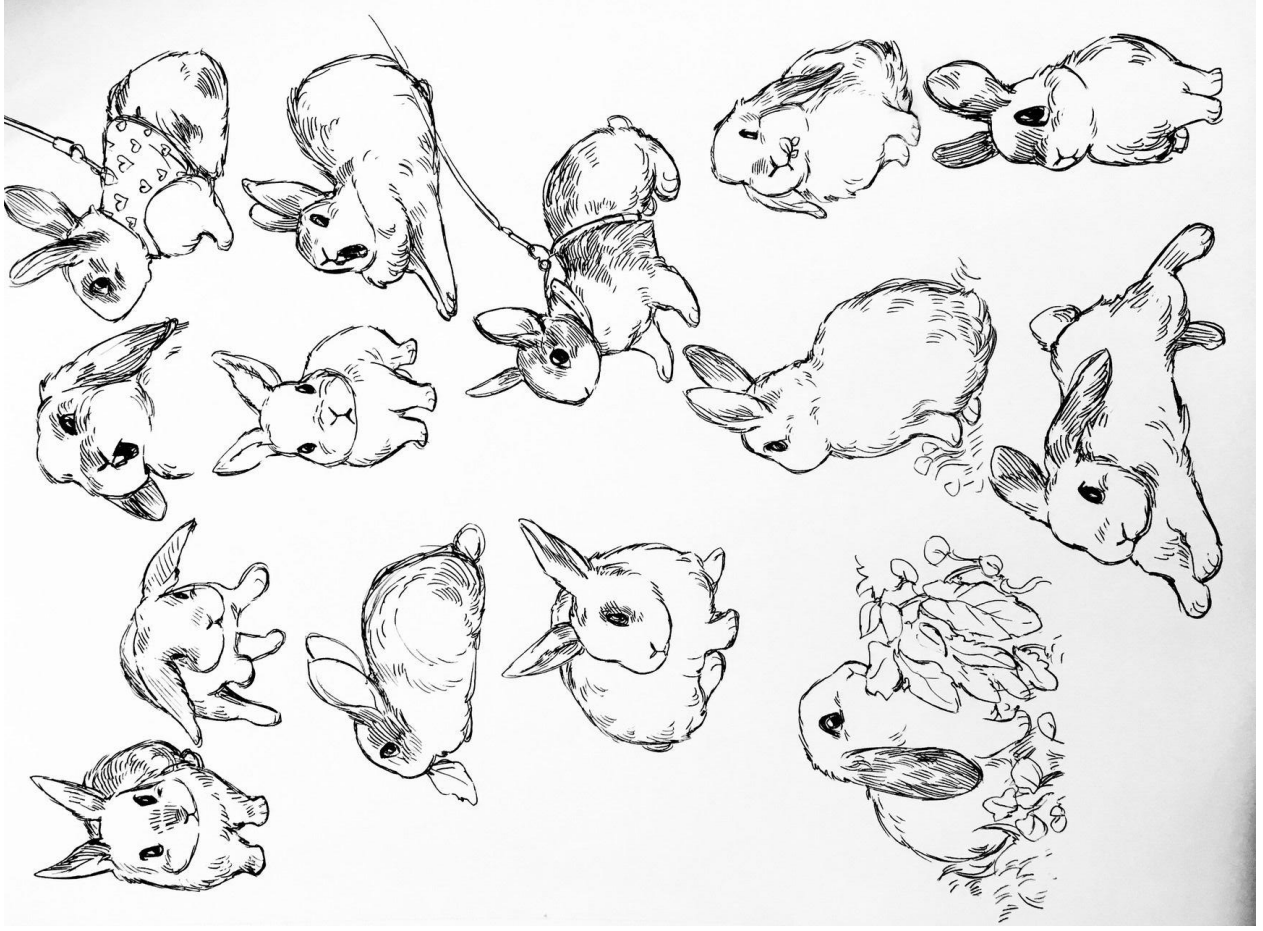

RABBITS

Their bodies are very elastic, and they double their length in stretched-out positions.

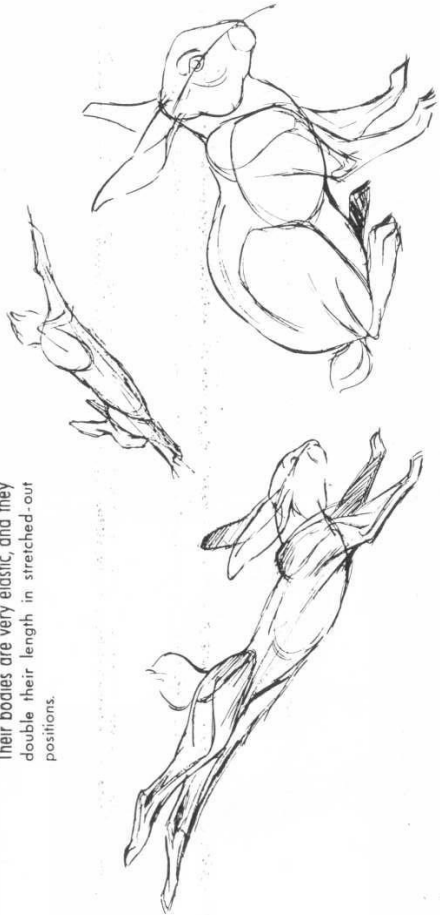

In the lower sketch, note the three basic units—head, chest, and the lower part of body.

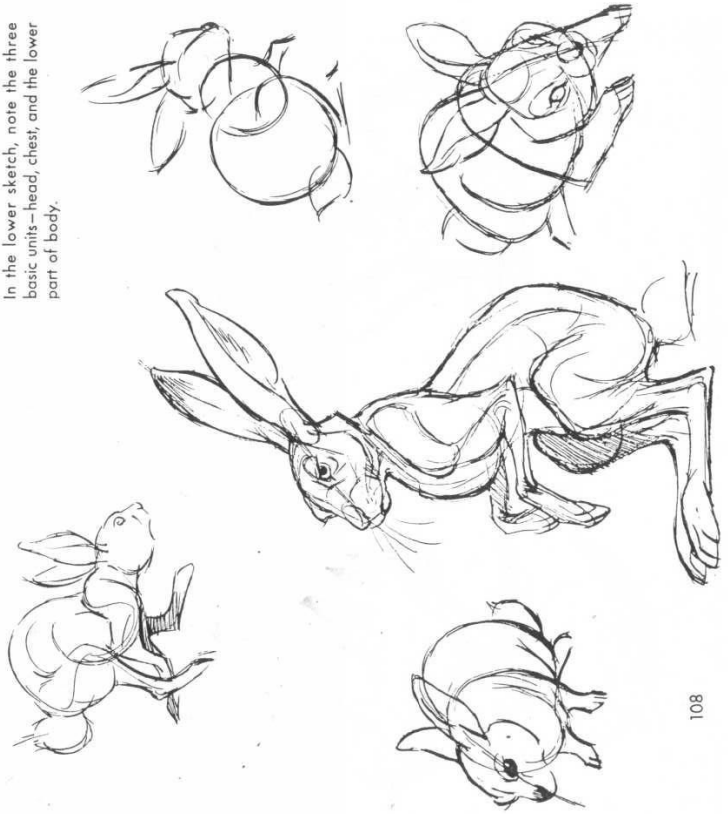



KANGAROOS

The rib cage is small, and the forelegs hang, rodent-like. Head and ears are similar to those of the deer. The tail is long and pointed and quite full at the base where it is attached to the body. The tail is very important to kangaroos, since they use it as a rudder and to help support their weight. Because of its prominence, it will give you a strong line of action, and add sweep to your drawing.

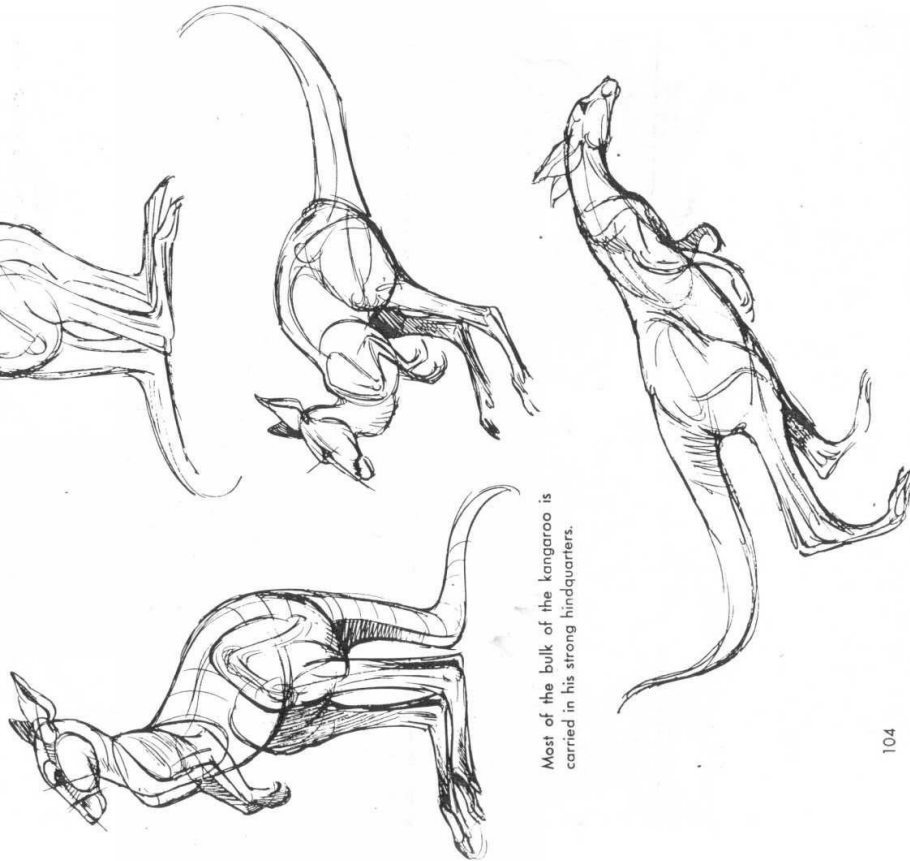

Most of the bulk of the kangaroo is carried in his strong hindquarters.

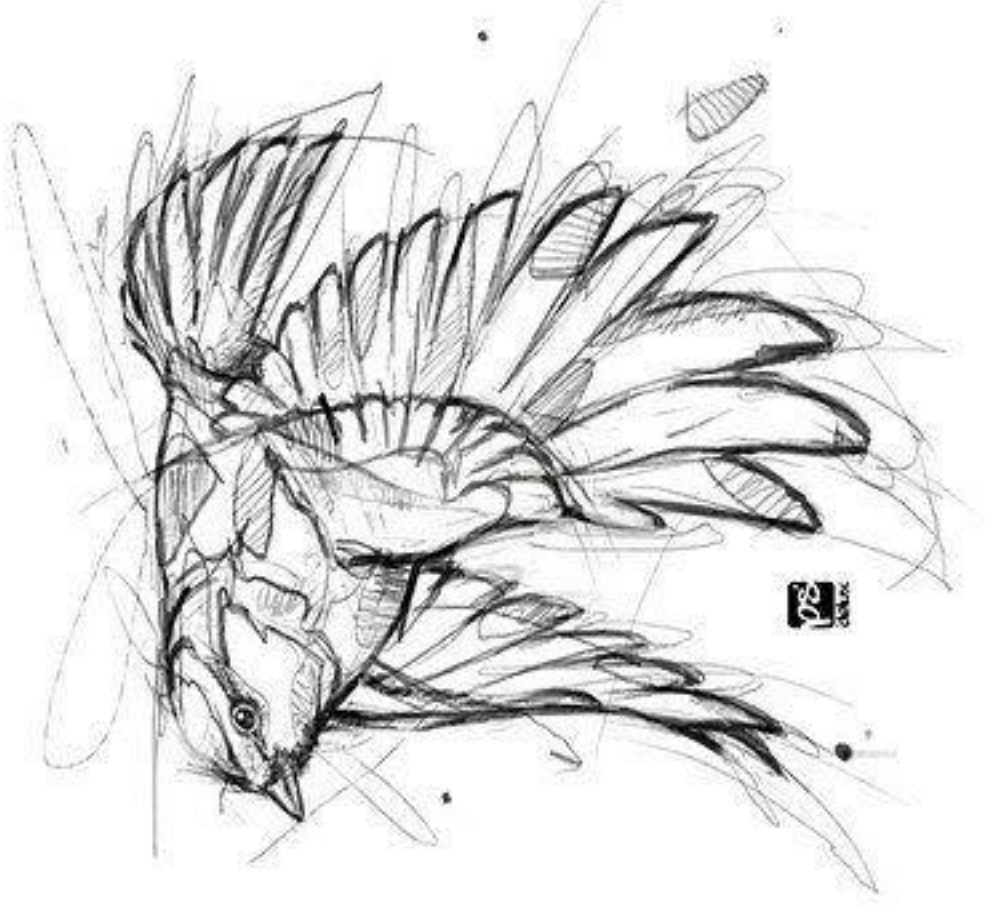

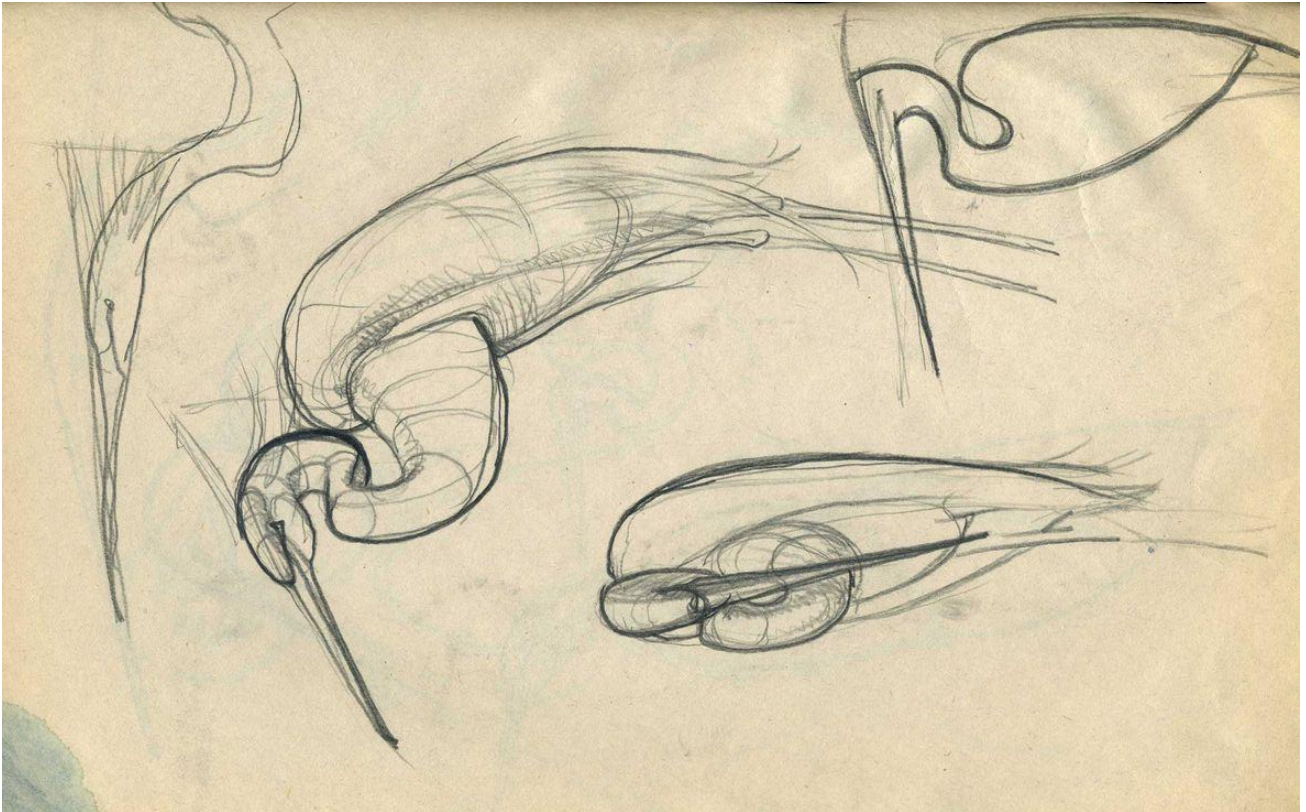
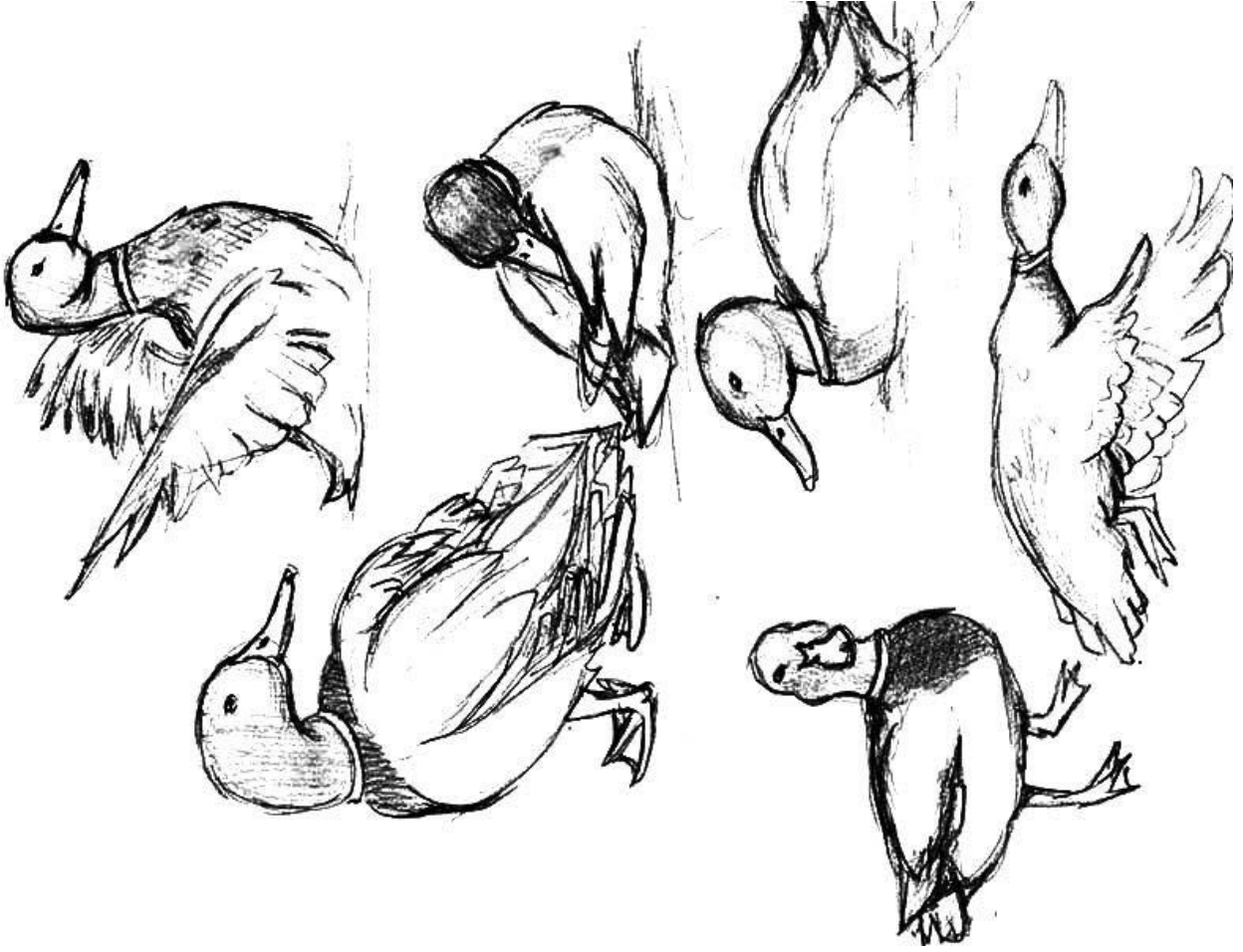













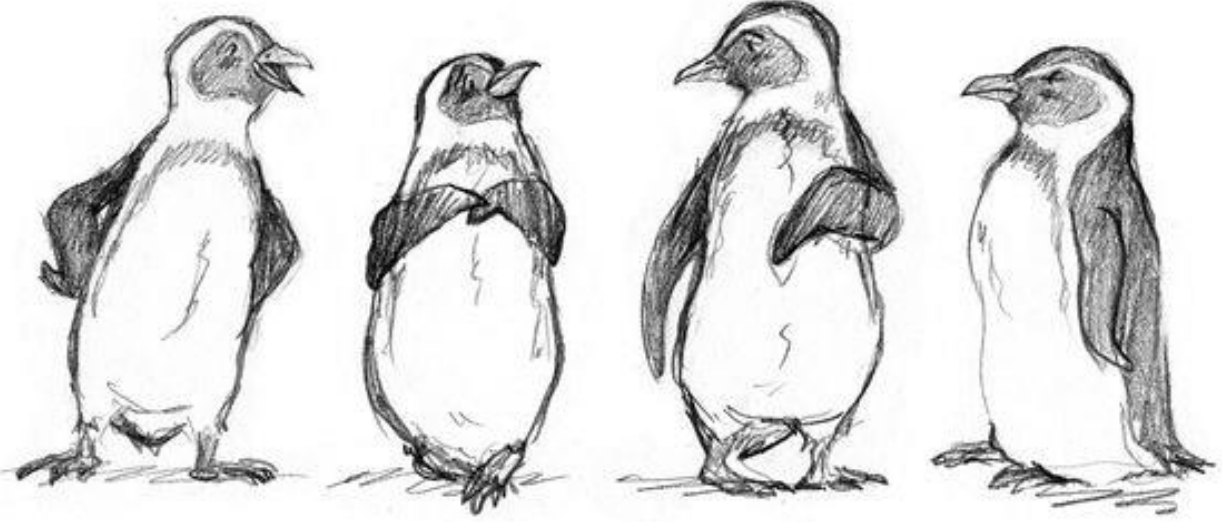
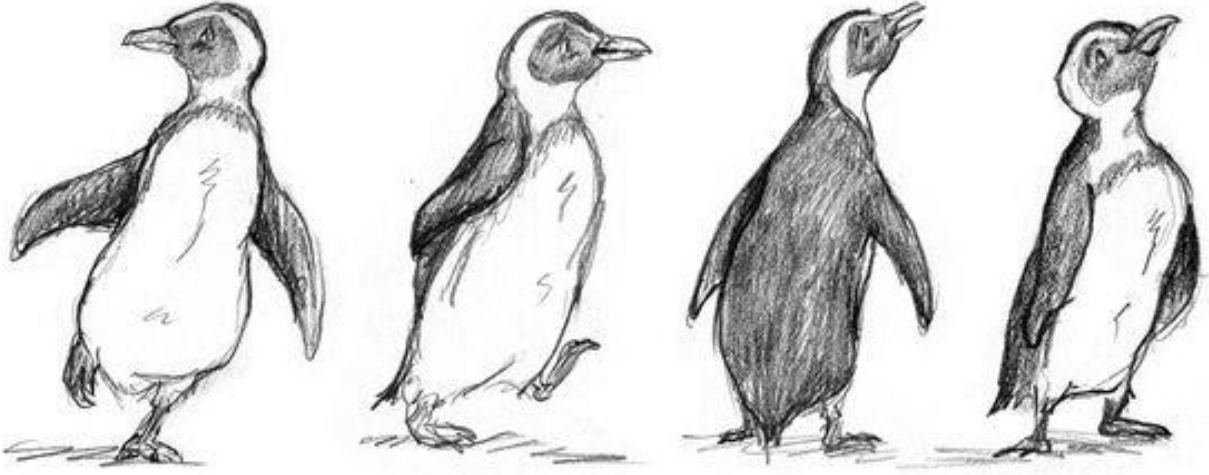

Zebras have beautifully striped patterns. As far as the artist is concerned the anatomy of the zebra is the same as the horse. Zebras have a large head, hooves that are smaller than most horses, a stiff, upright mane, and a narrow tail terminating in a long tuft of hair. Other zebra characteristics are large ears, and a rounded body shape. The striped pattern must follow the form to show proper volume.

## Zebras

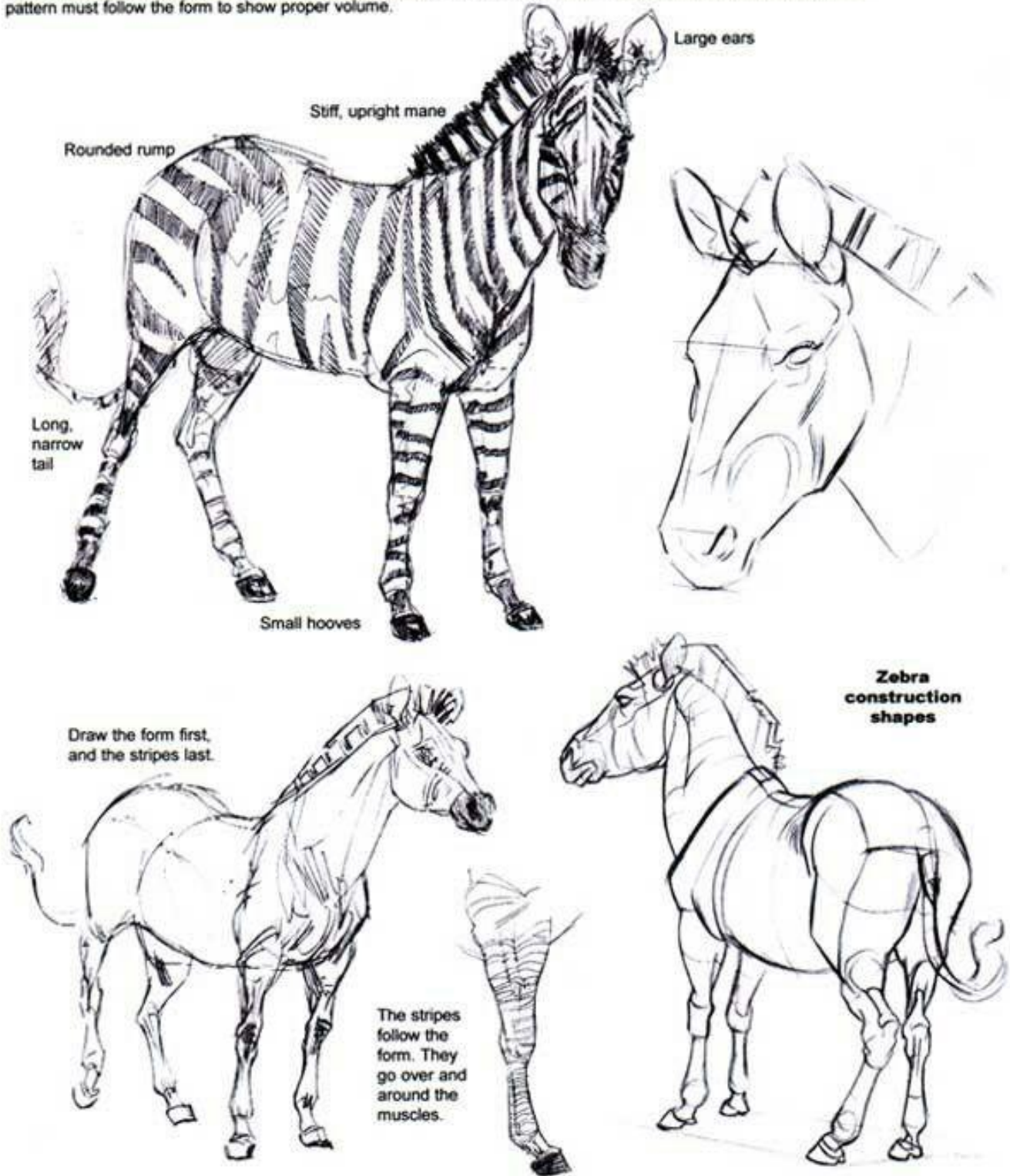

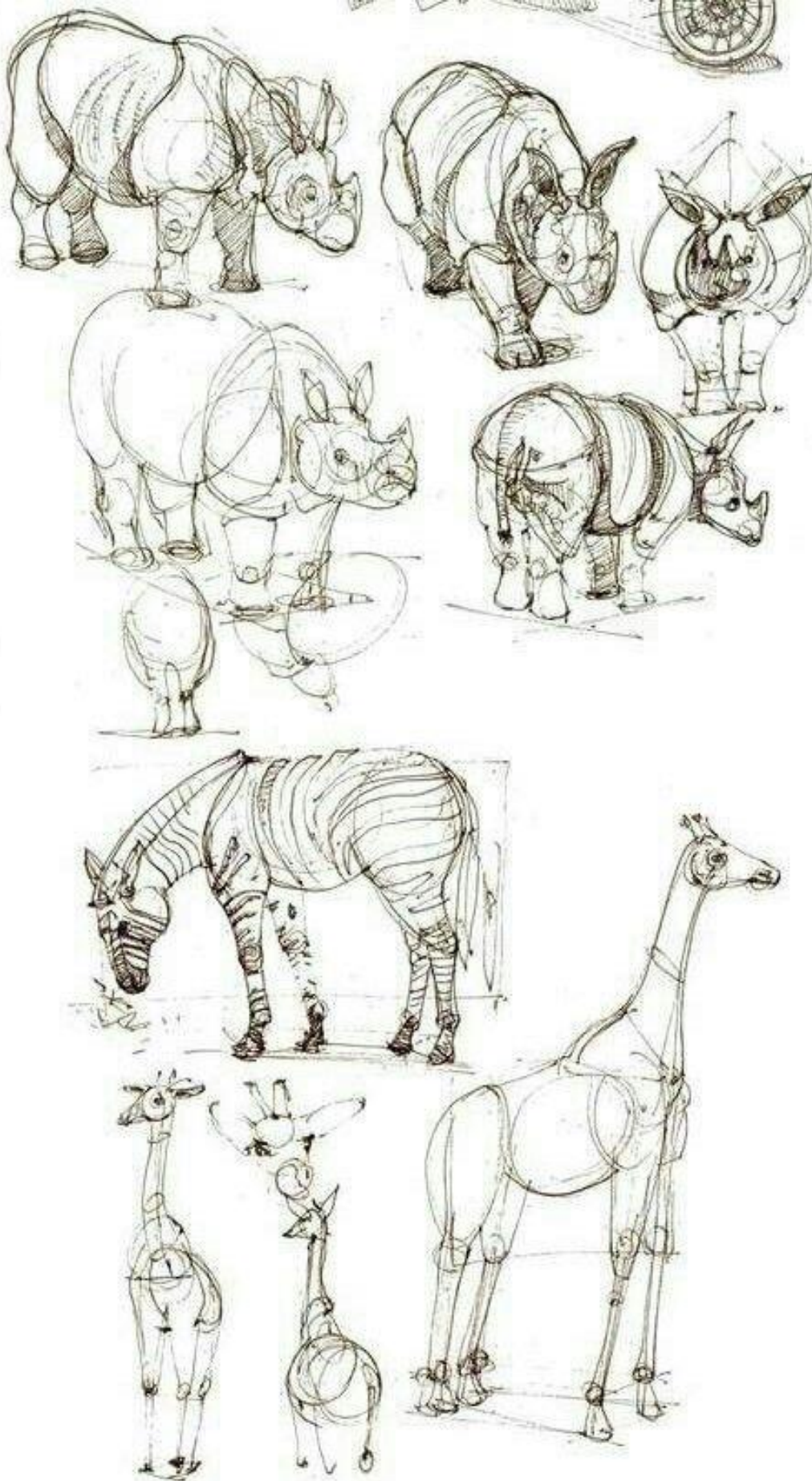

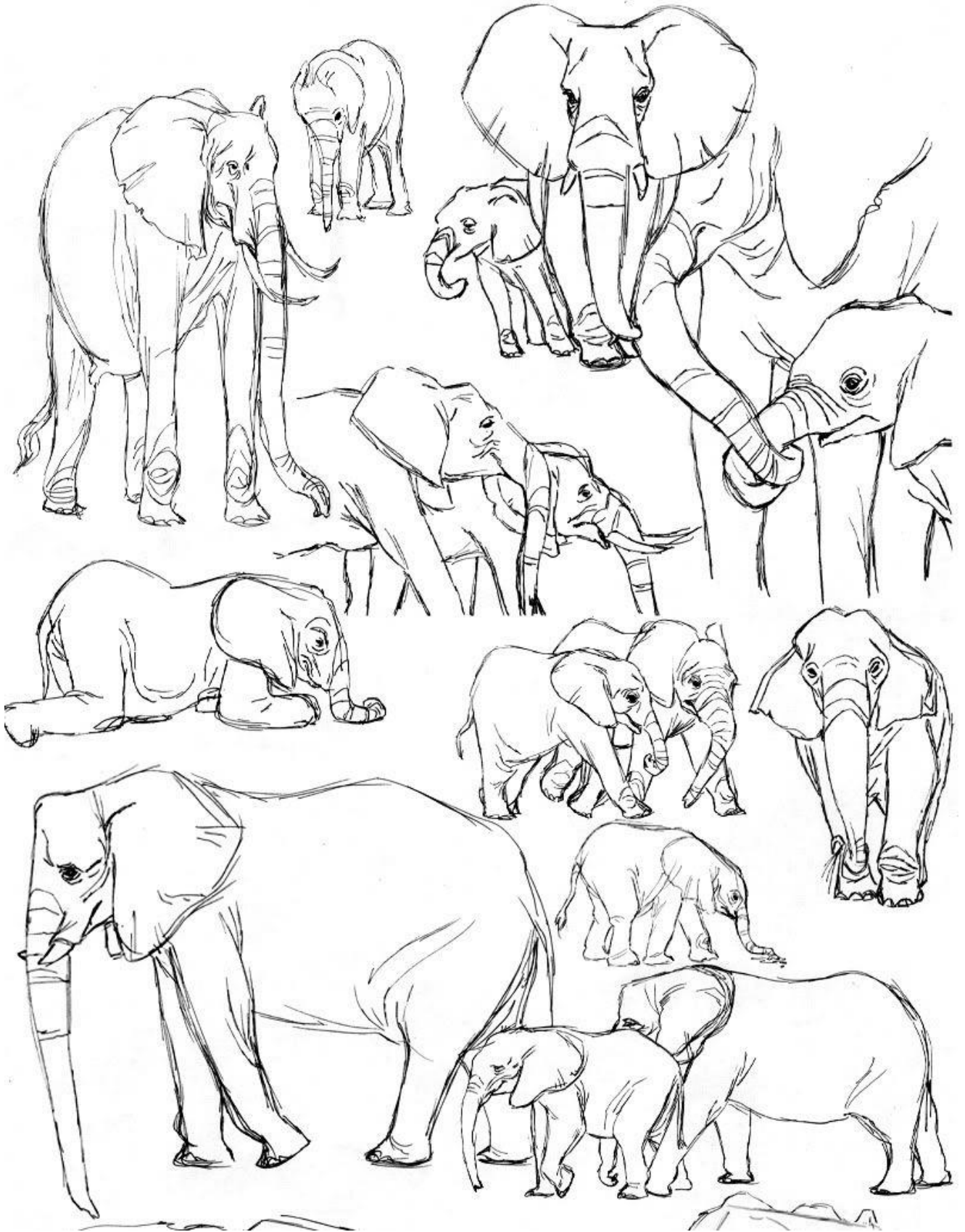

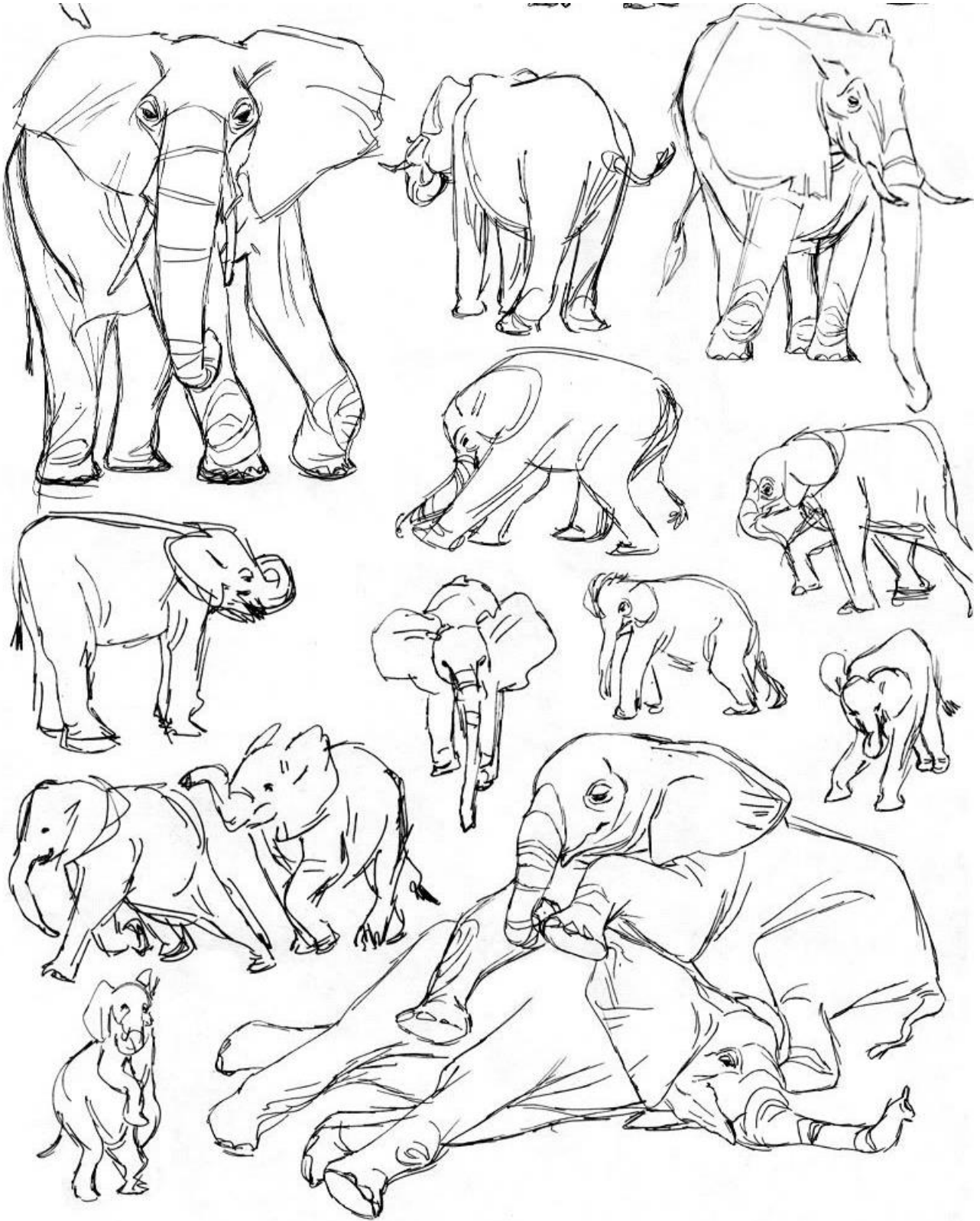

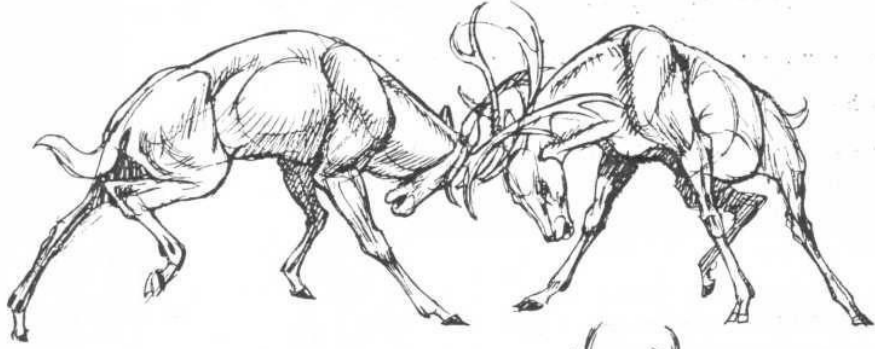
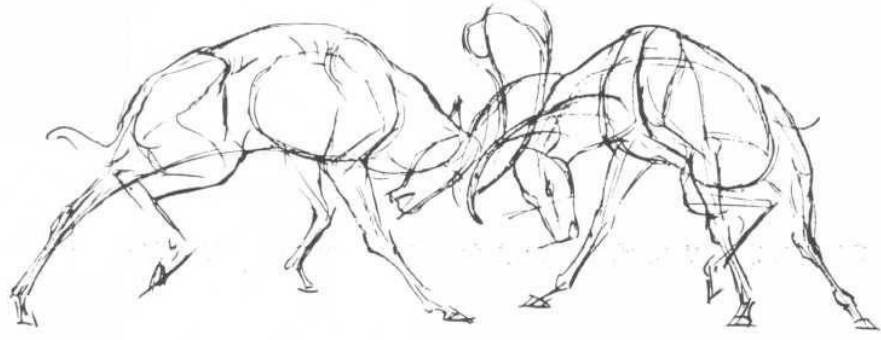

A few lines can suggest many forms.

It is helpful to have a strong line of action, leading from the rear leg to the head.





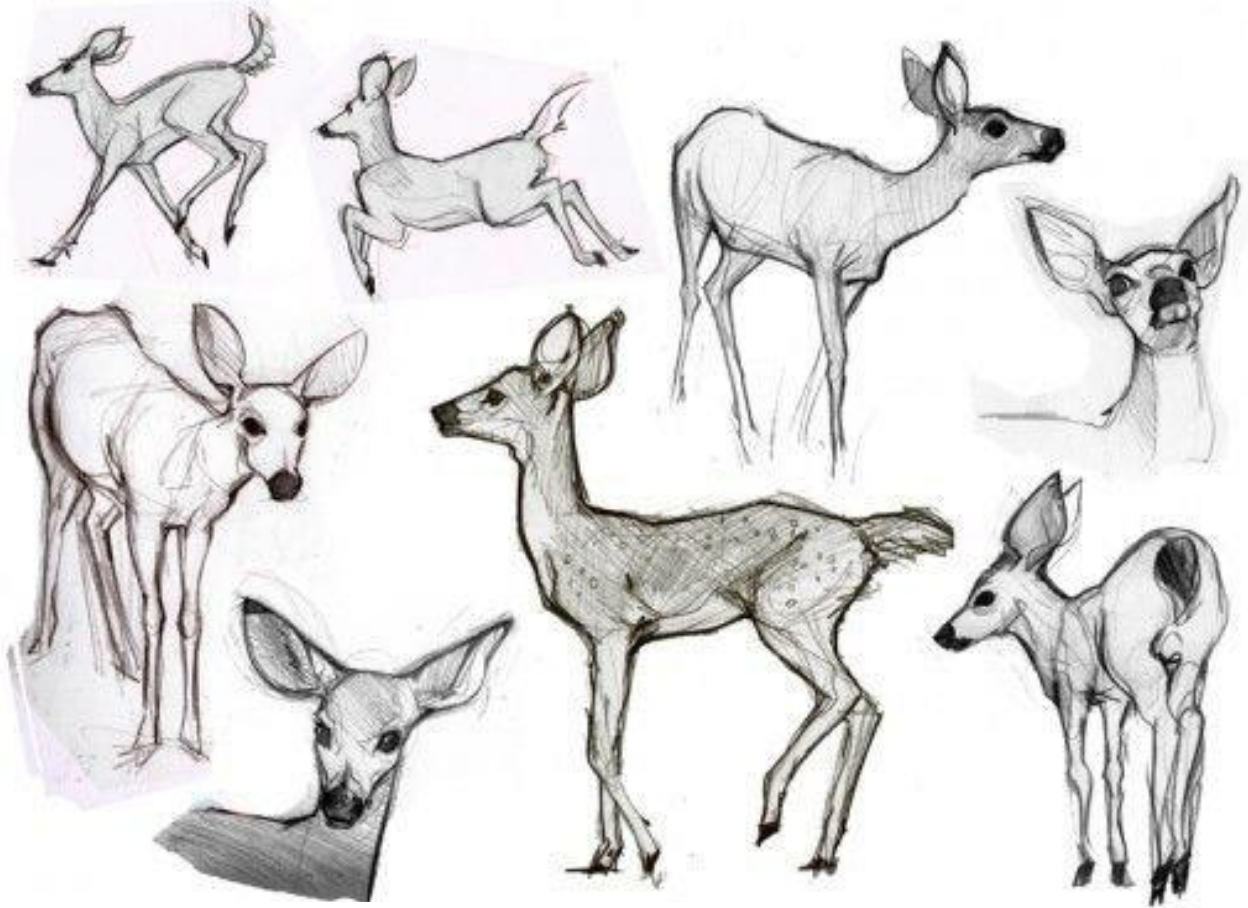

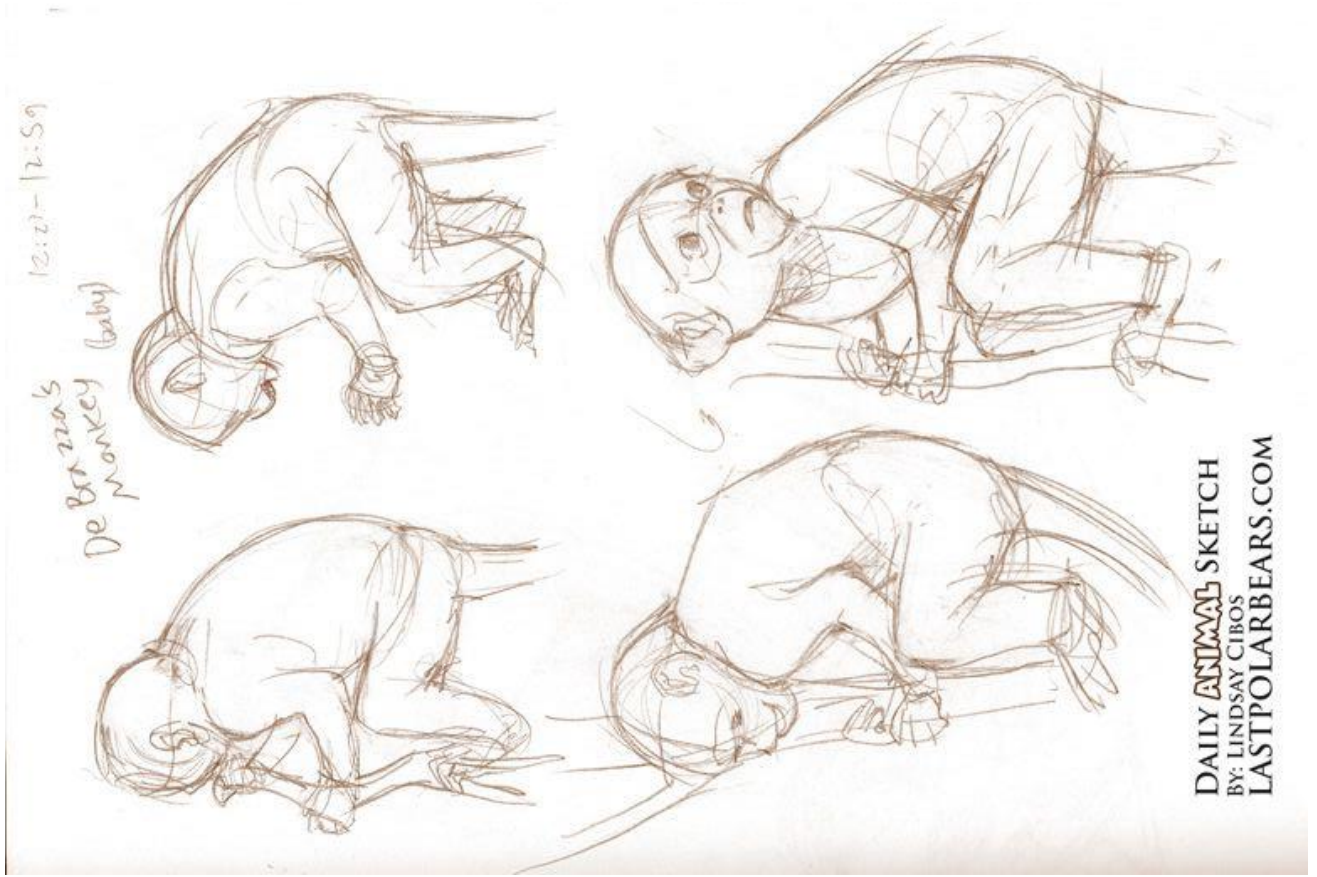

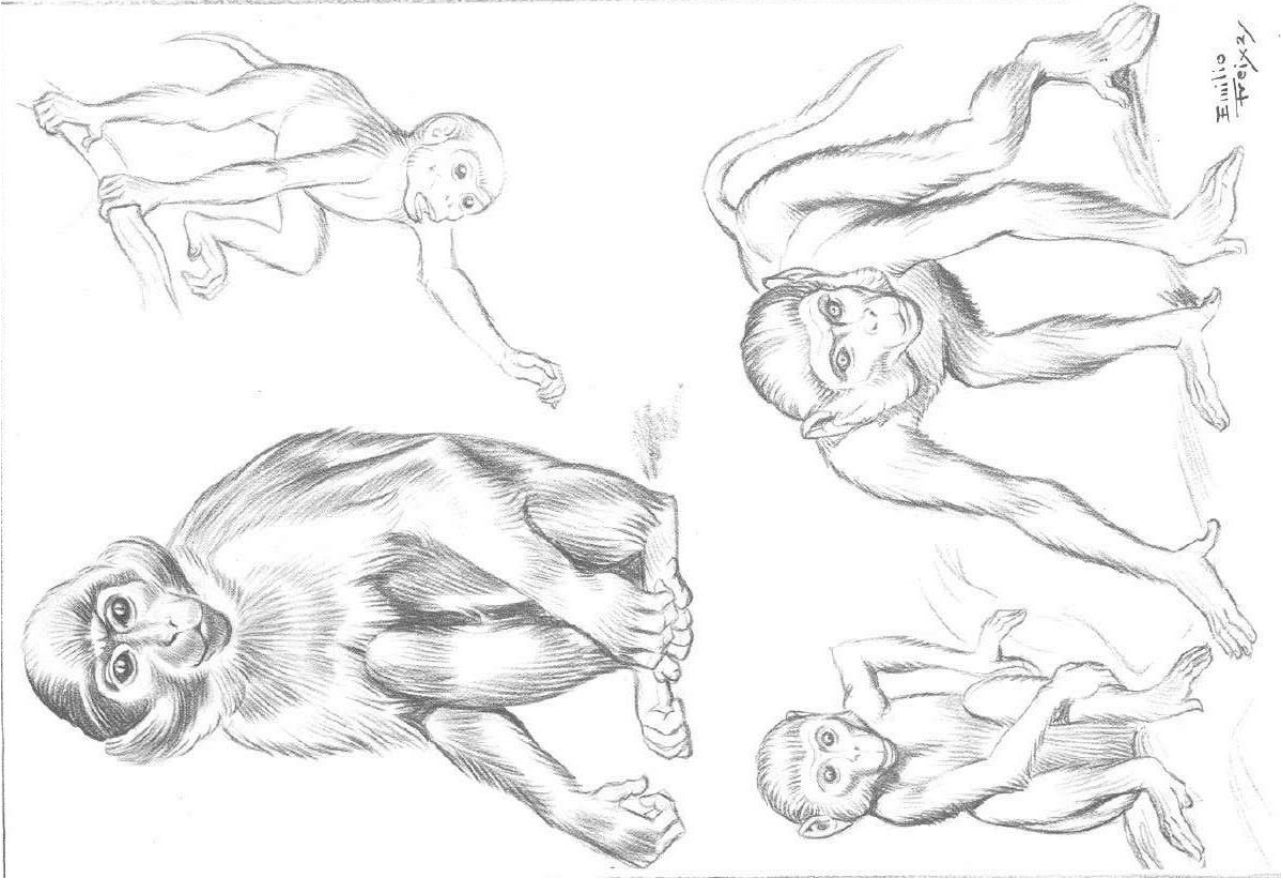

The Weatherly Guide to Drawing Animals

## The Principles of Construction

Drawing using construction not only allows for solid drawing from life, but also the ability to draw from imagination. Construction is conceiving the form in terms of basic geometric shapes and it must become an instinctive part of drawing. Practice it until it becomes automatic. If you can draw a box, sphere, cylinder, and ovoid shape then you can draw any animal. Most angles and foreshortened views can be simply broken down by using basic shapes to construct. Always remember to draw through the forms as though they were made of glass. This will help you to see through and help visualize relationships.

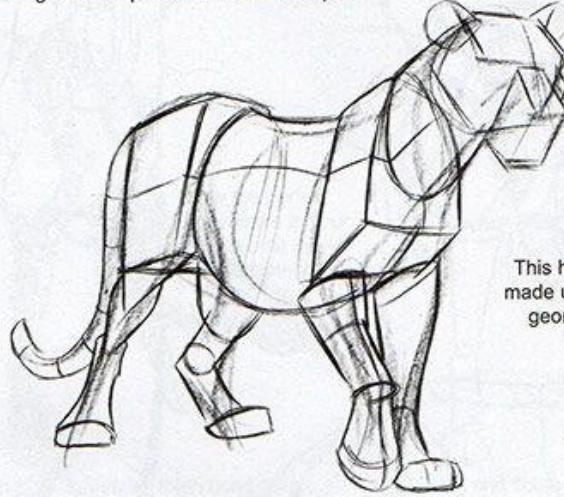
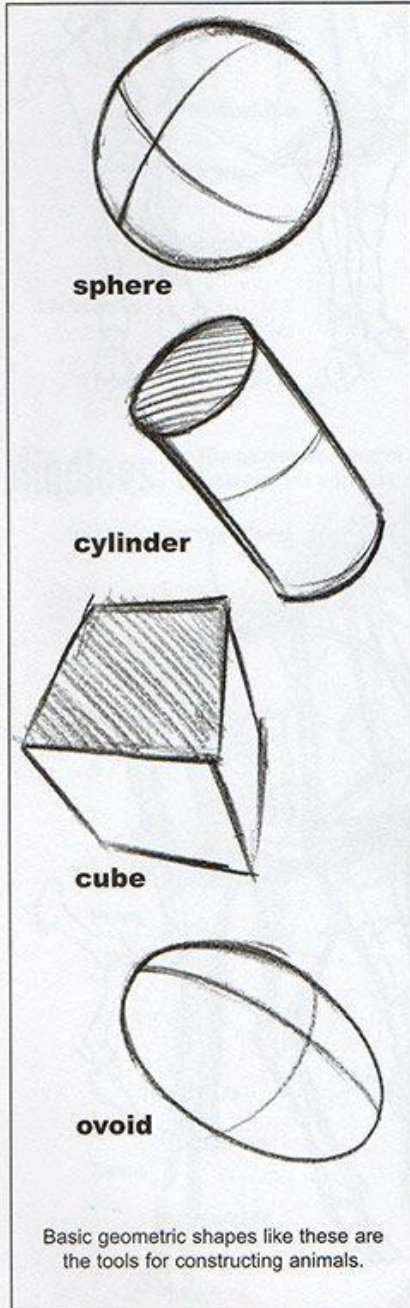

This horse, bear and lion are made up from a series of basic geometric shapes like the ones on the left.

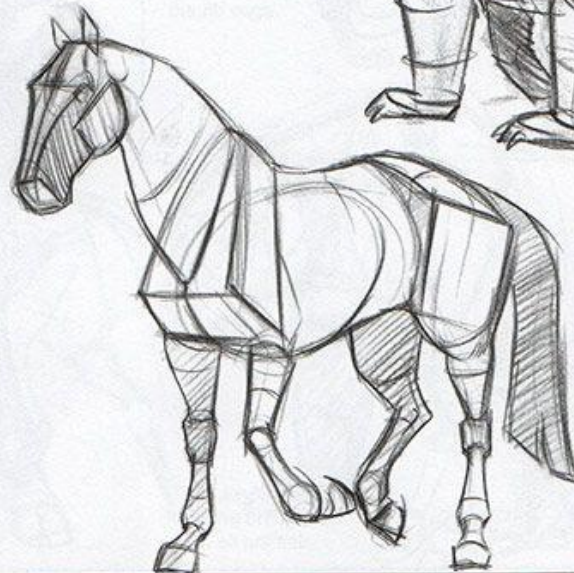



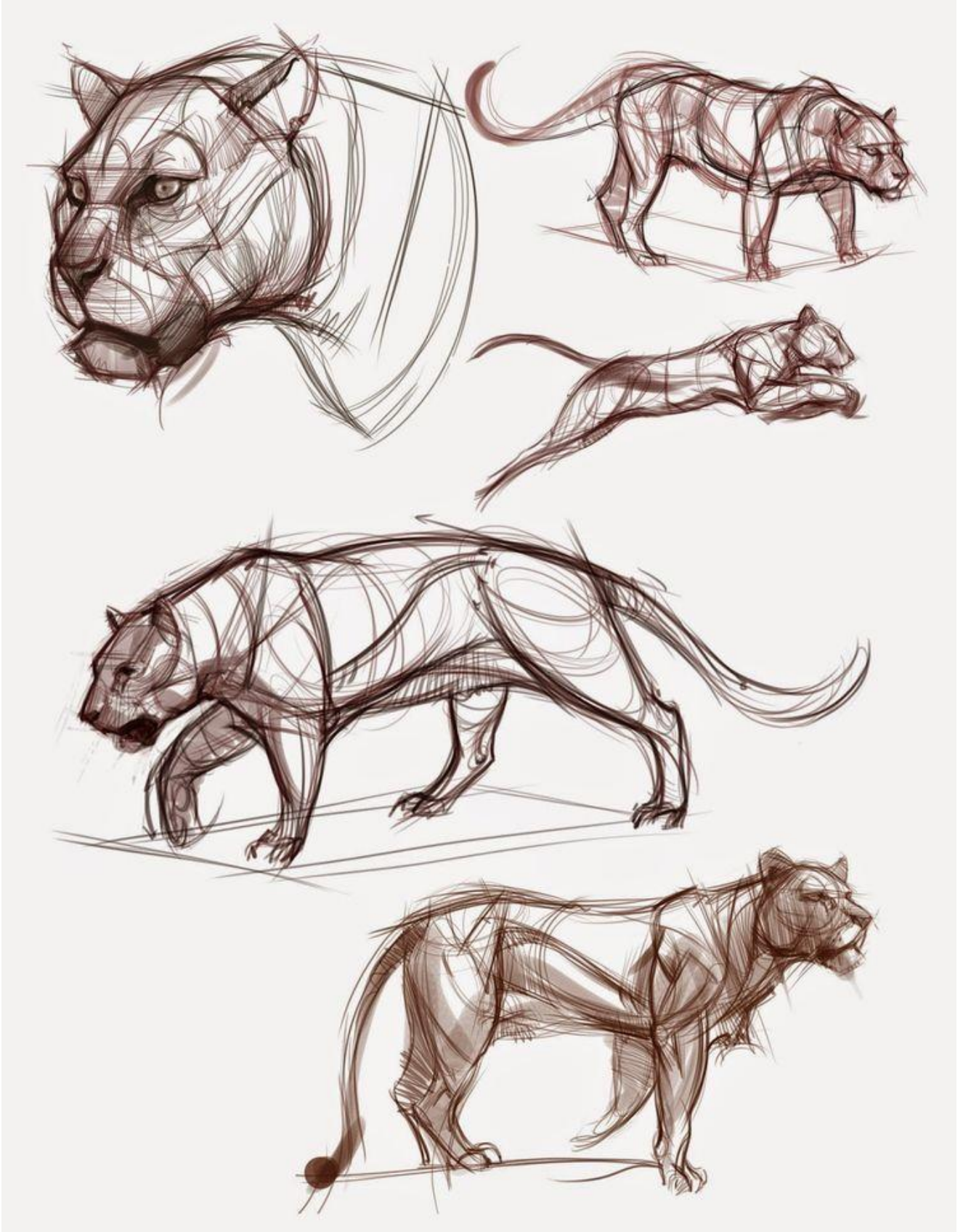







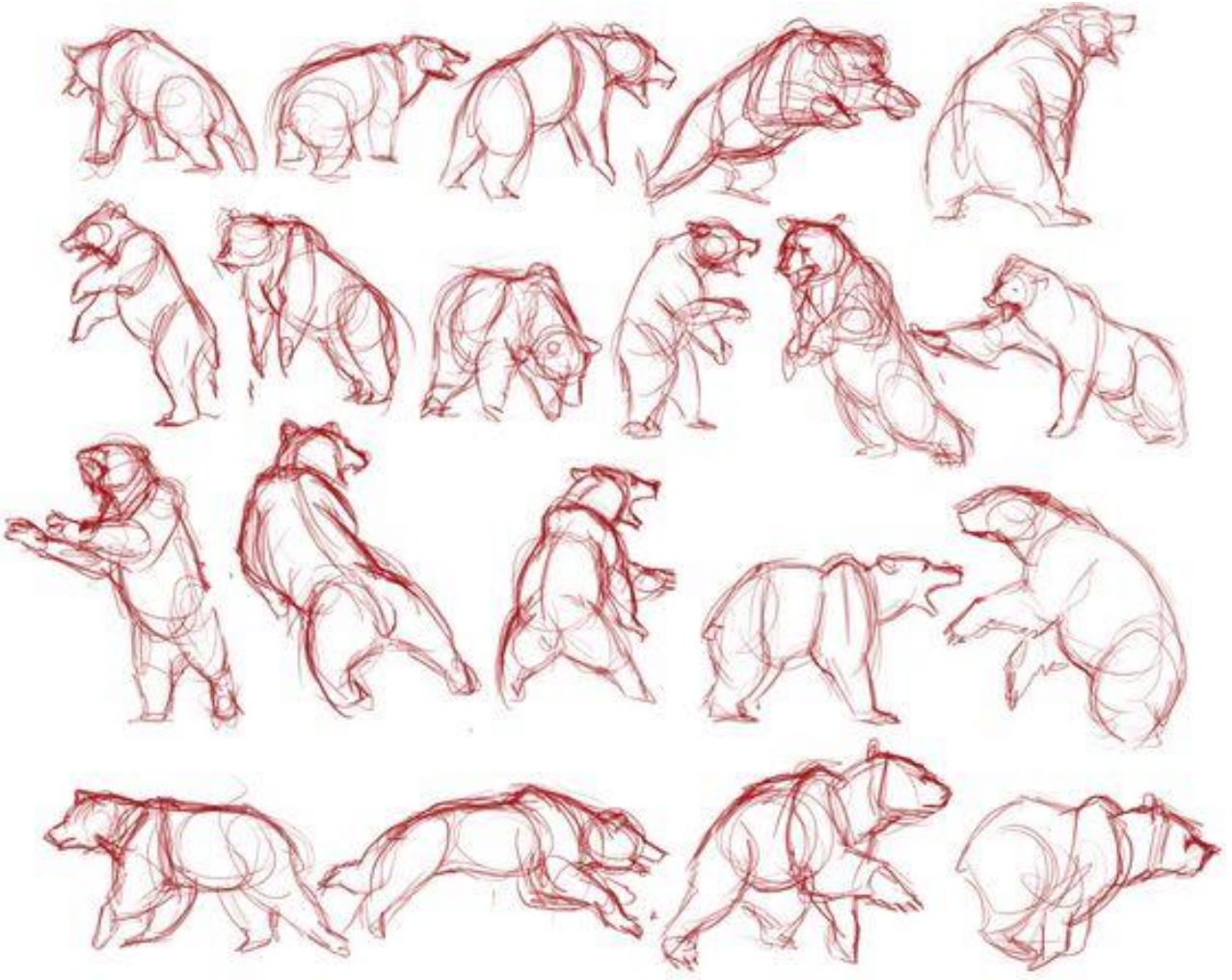

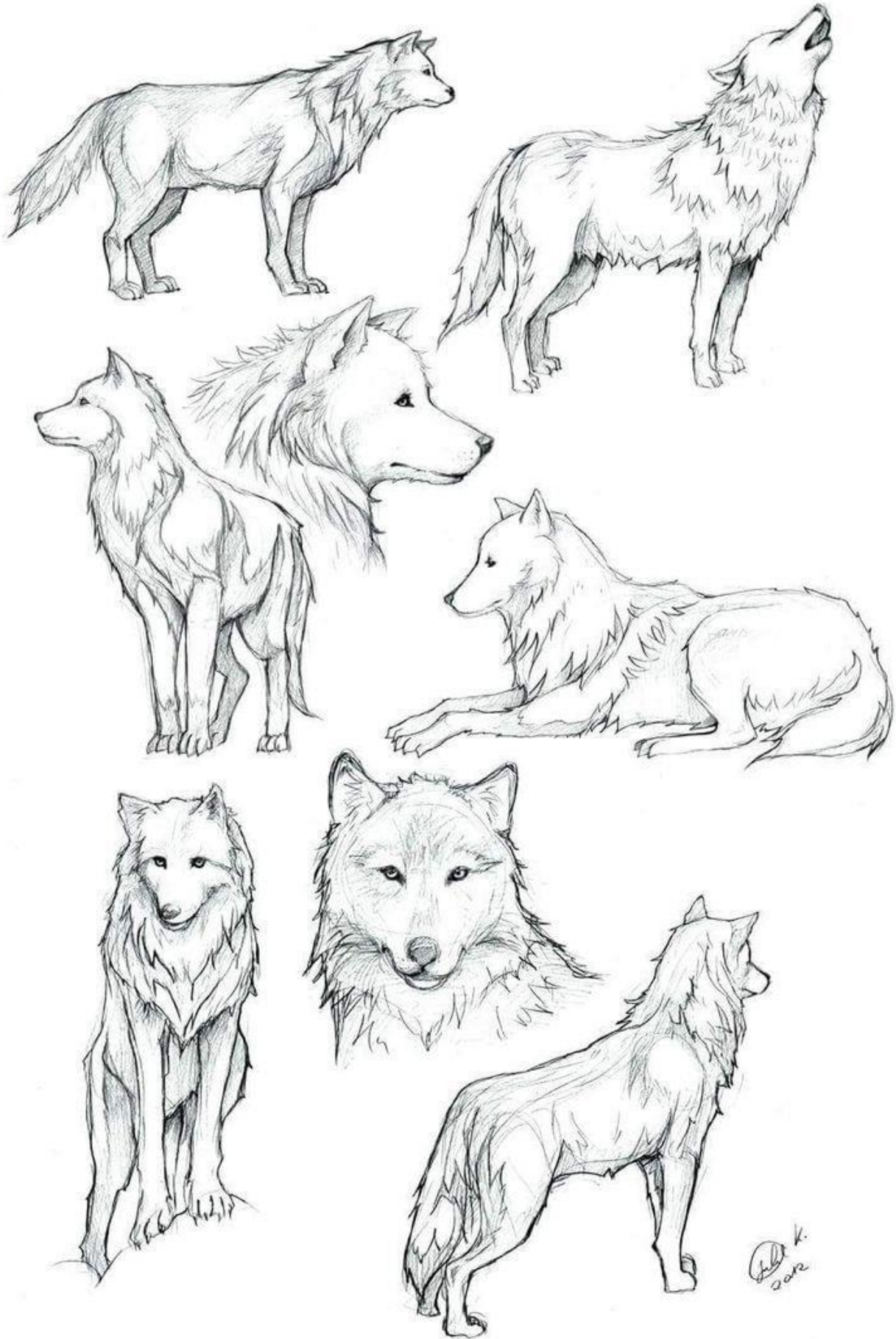

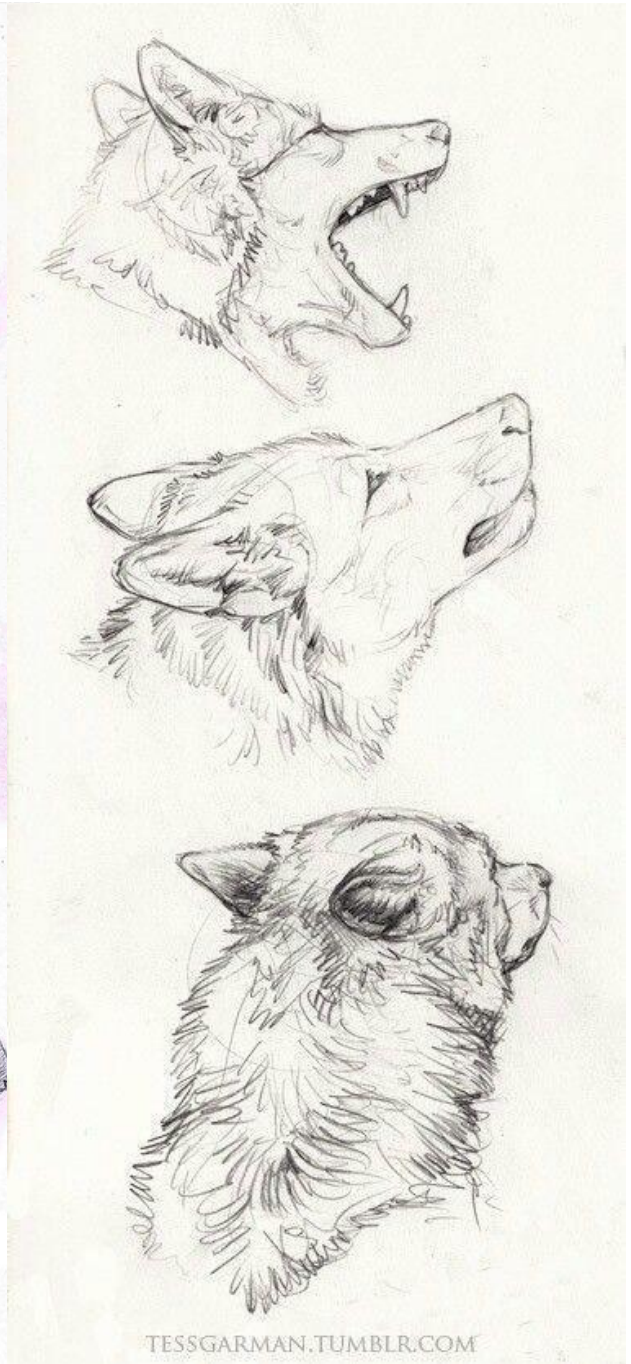
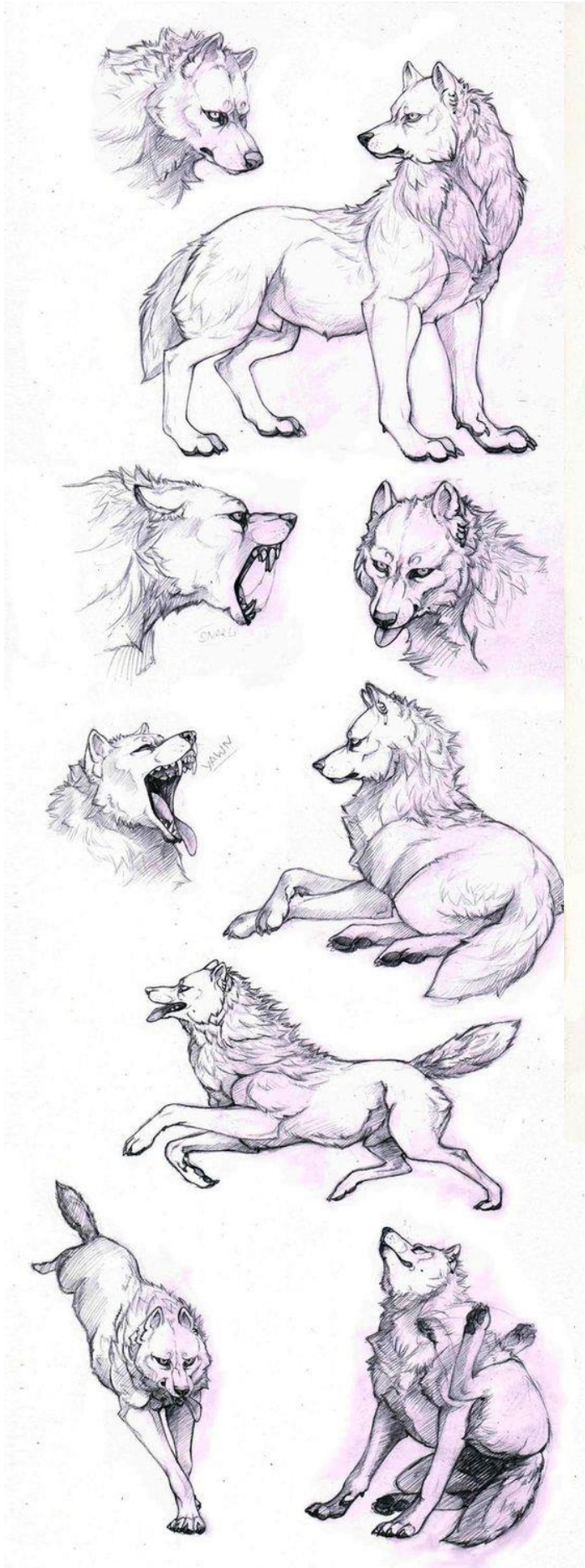



SGARMAN.TUMBLR.COM



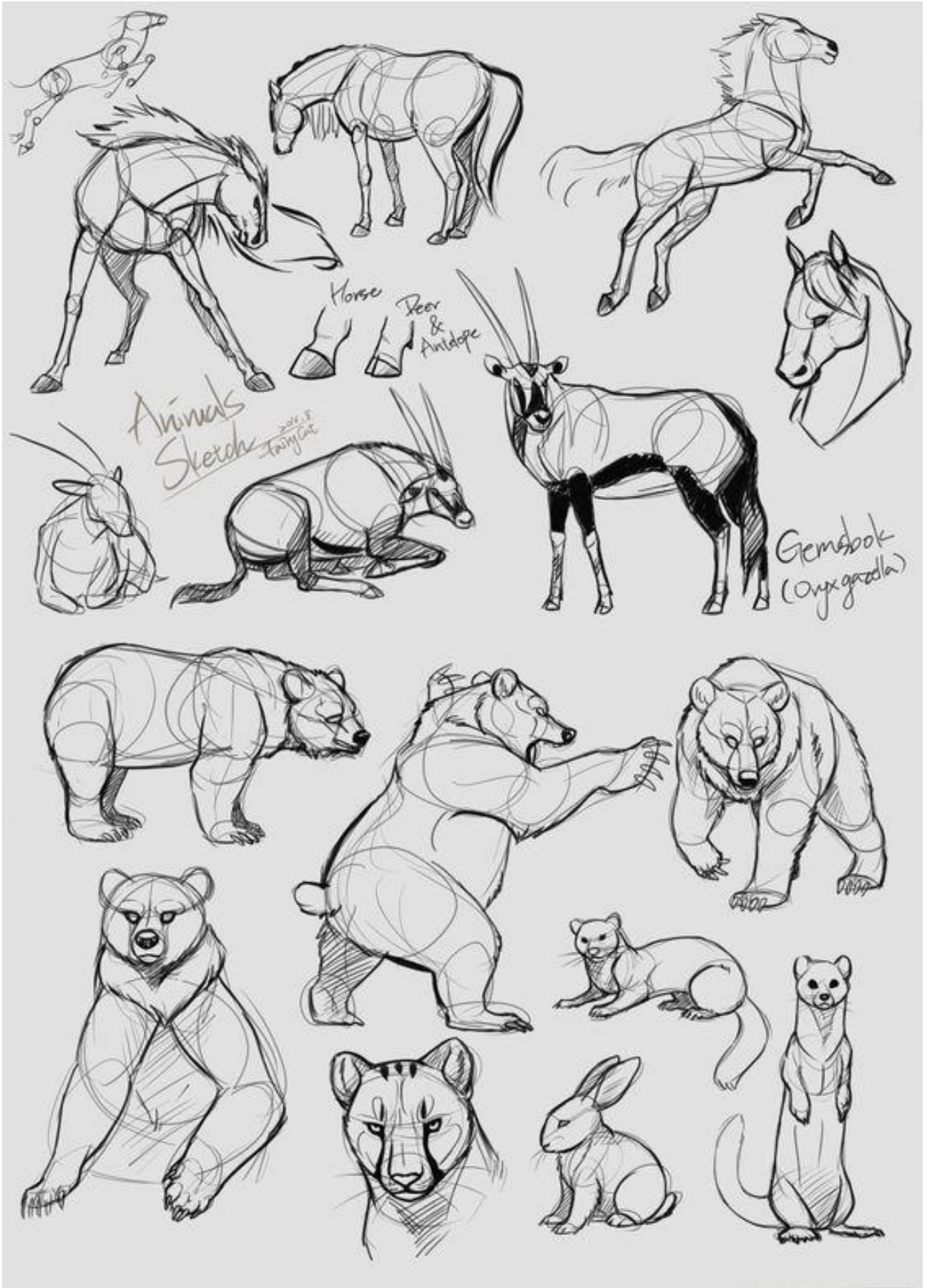

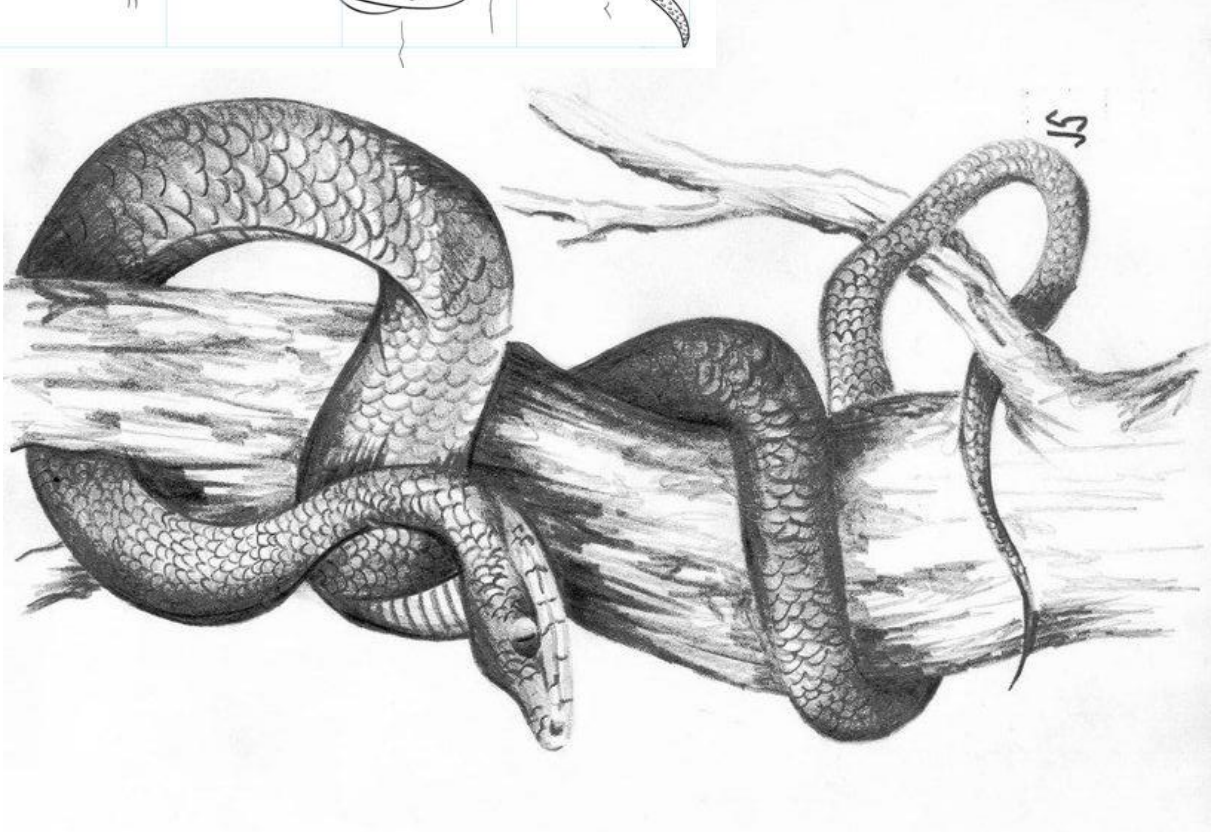
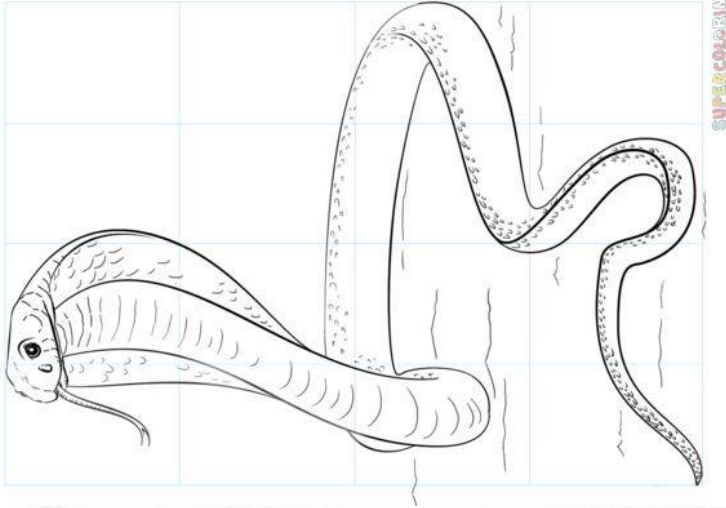
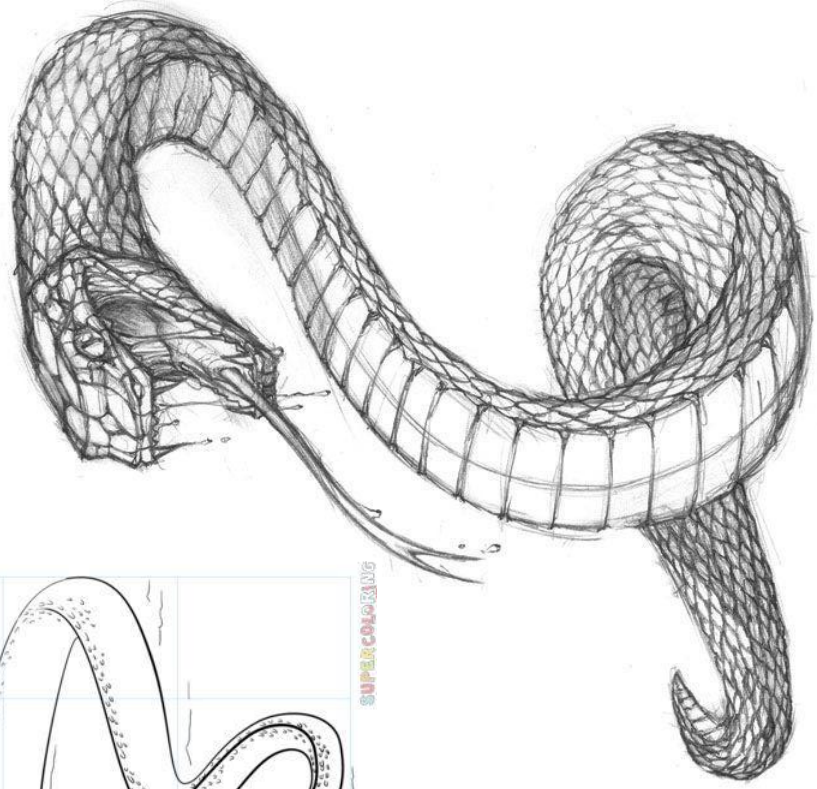

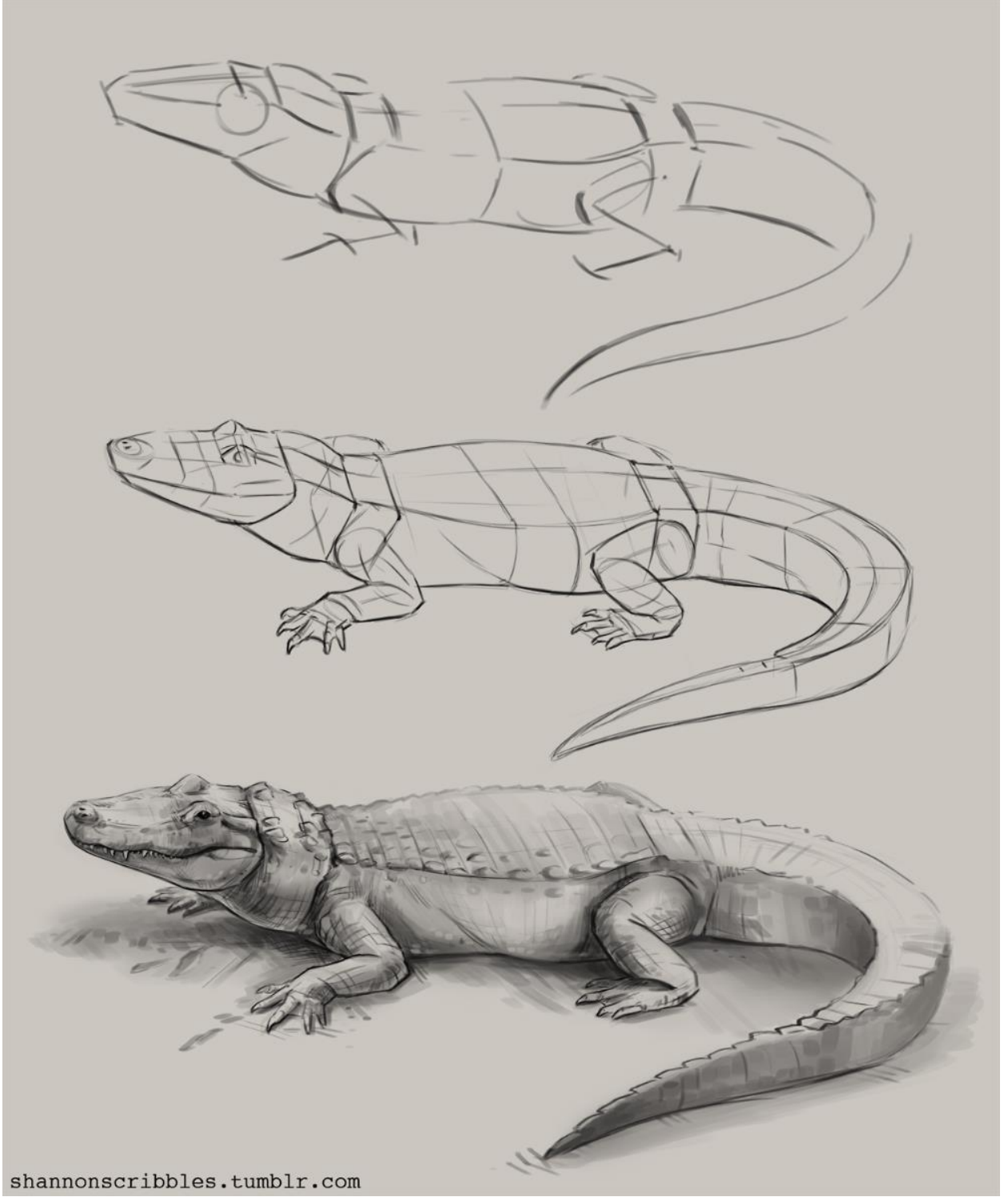





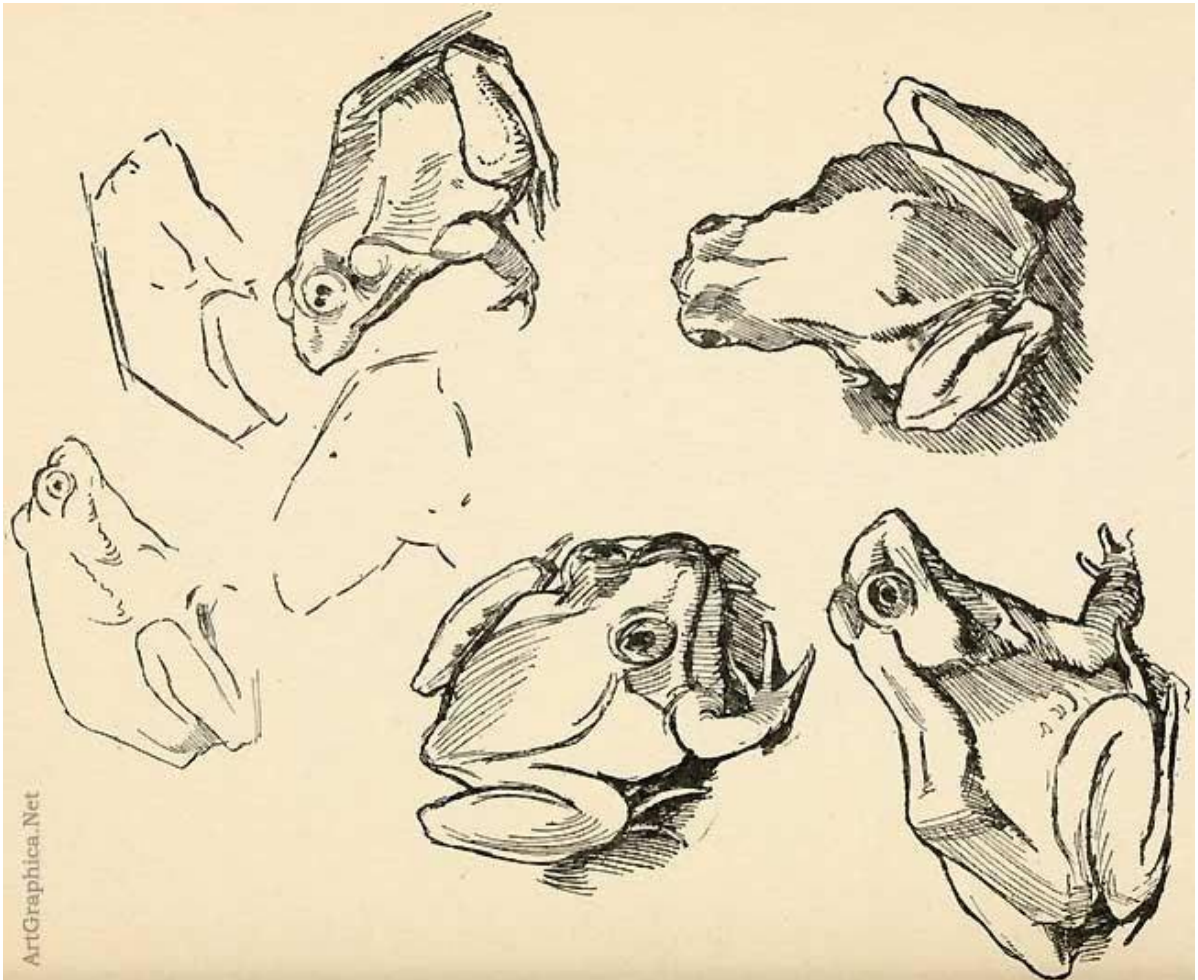
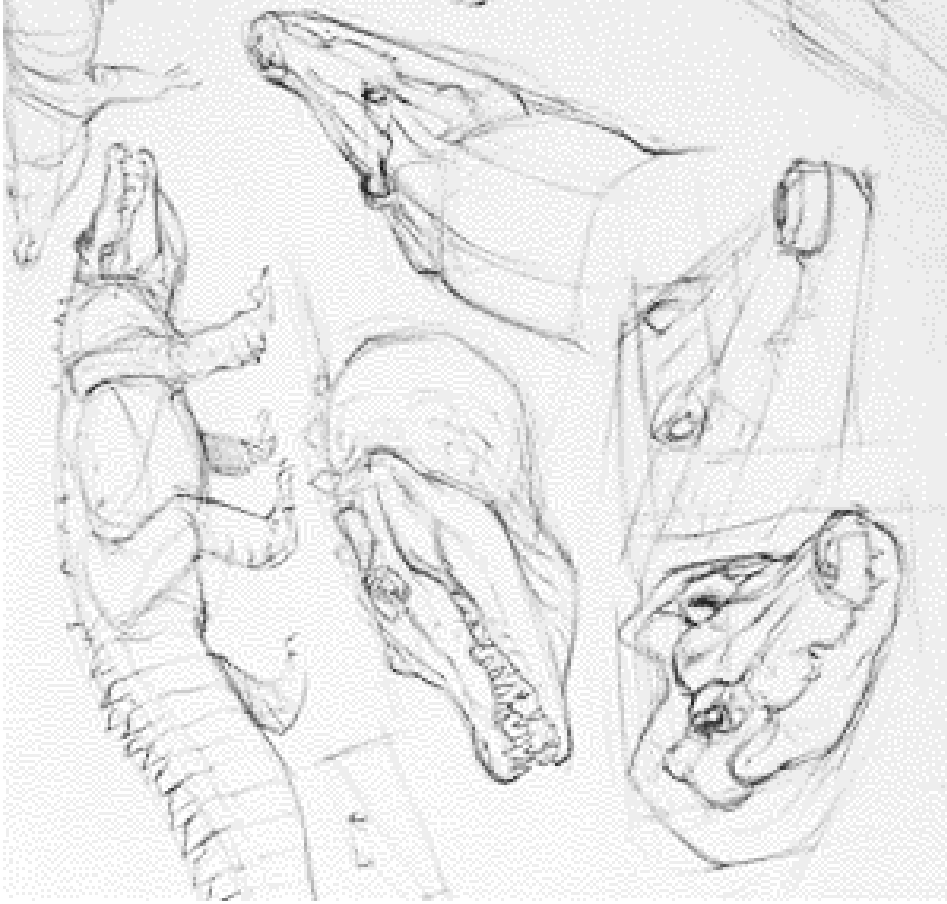

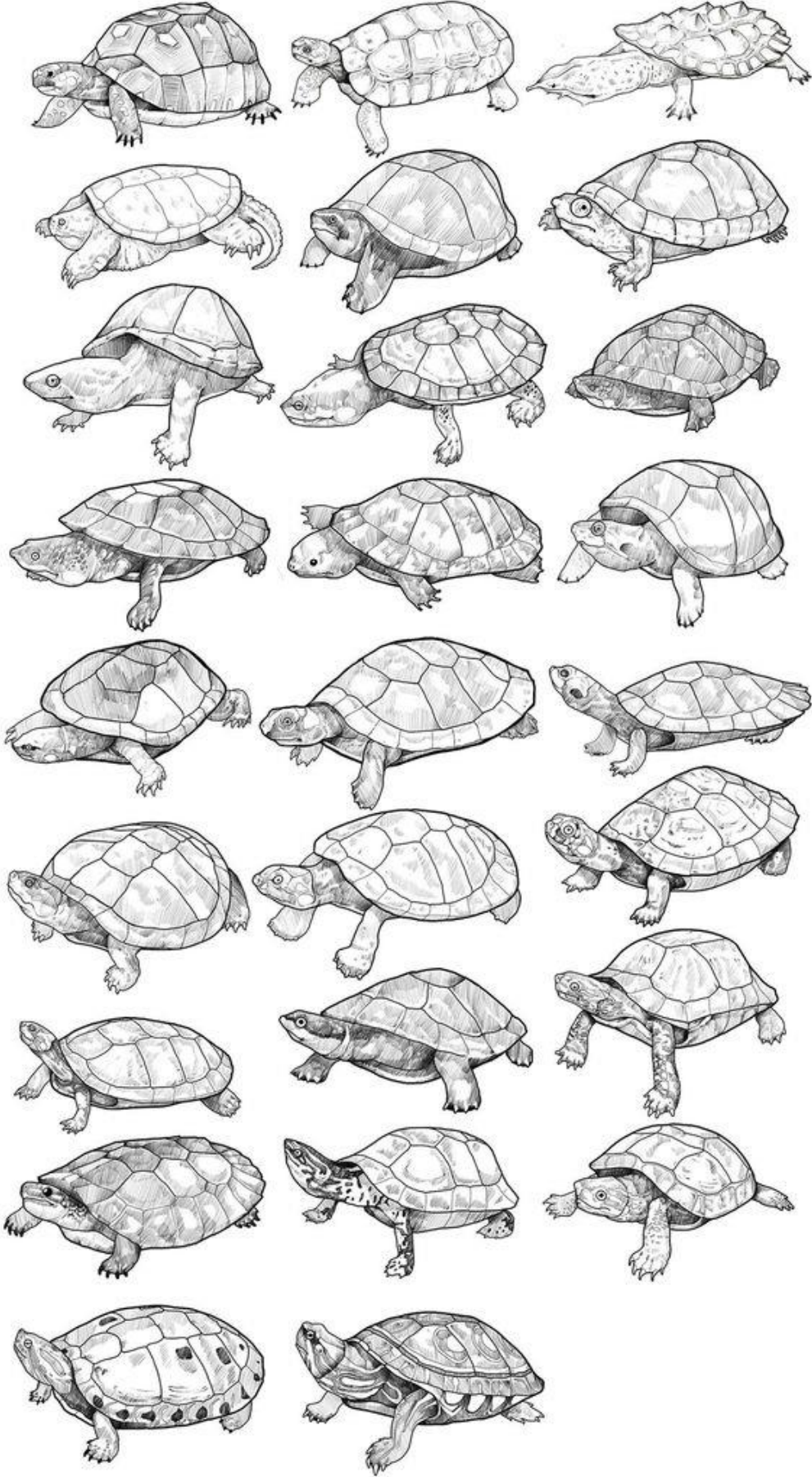

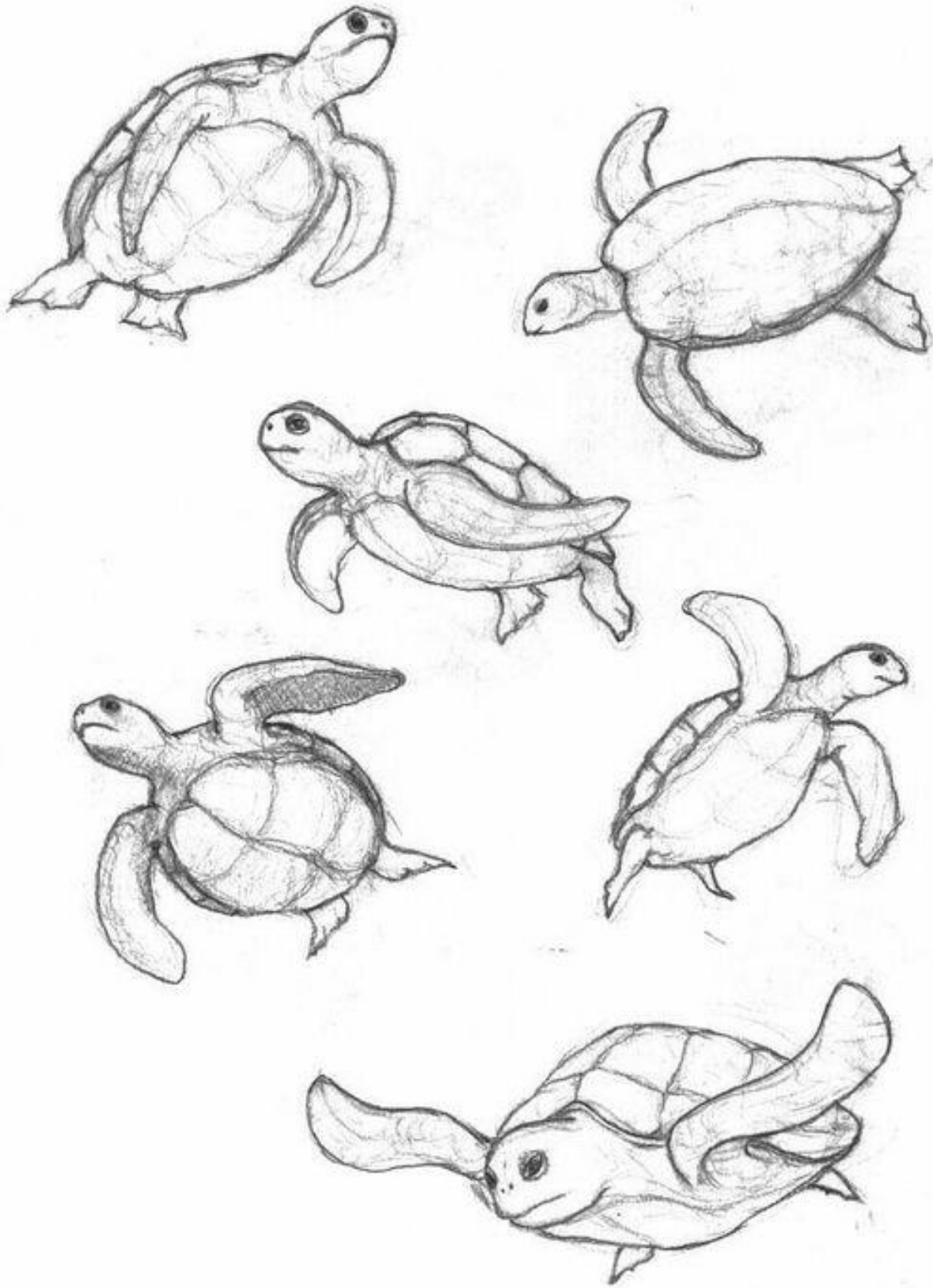



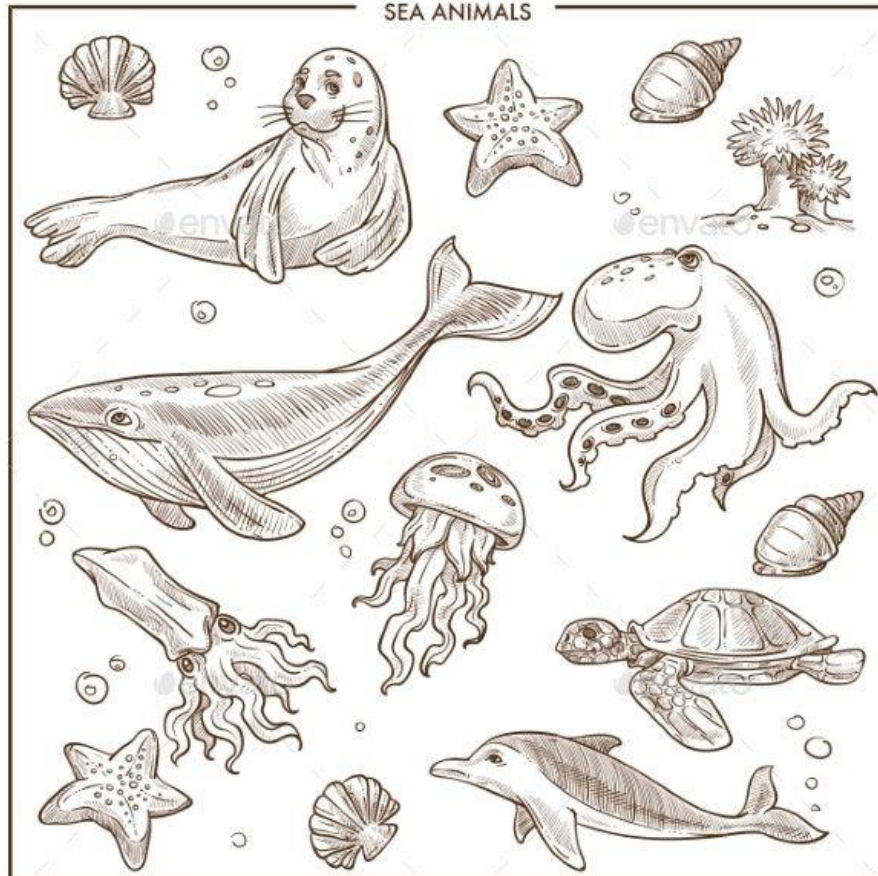
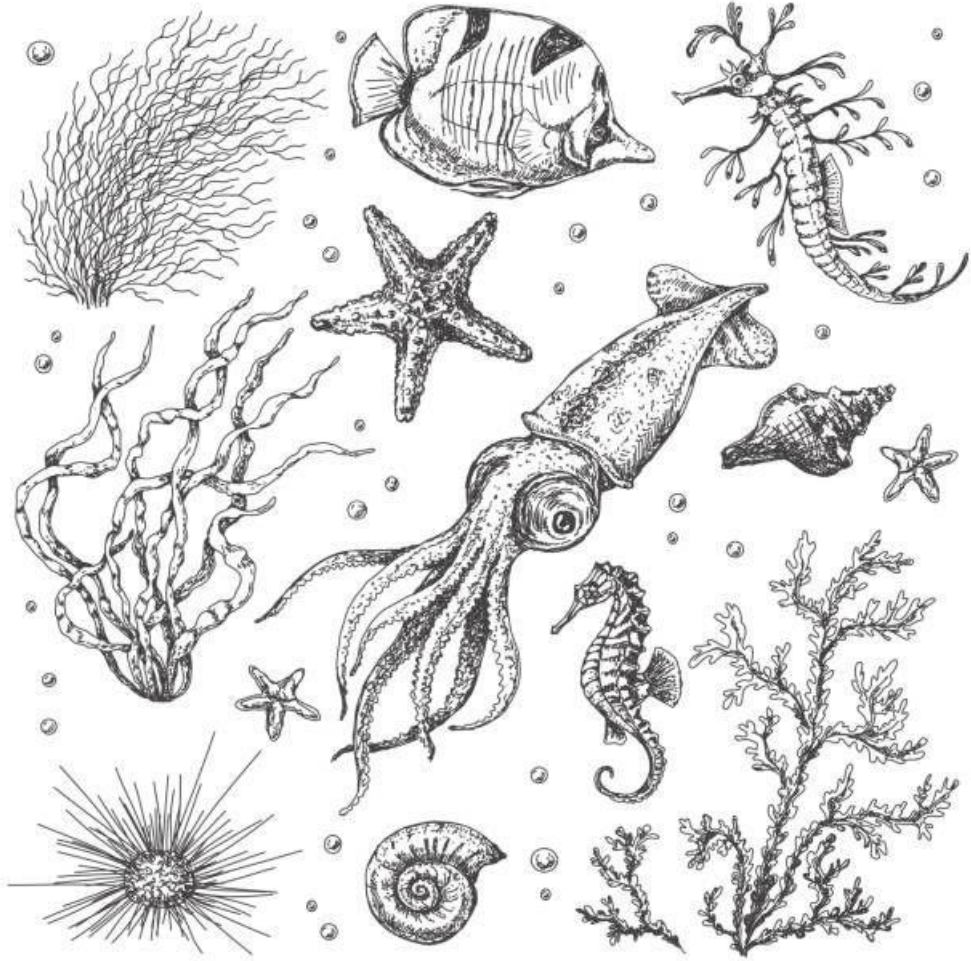

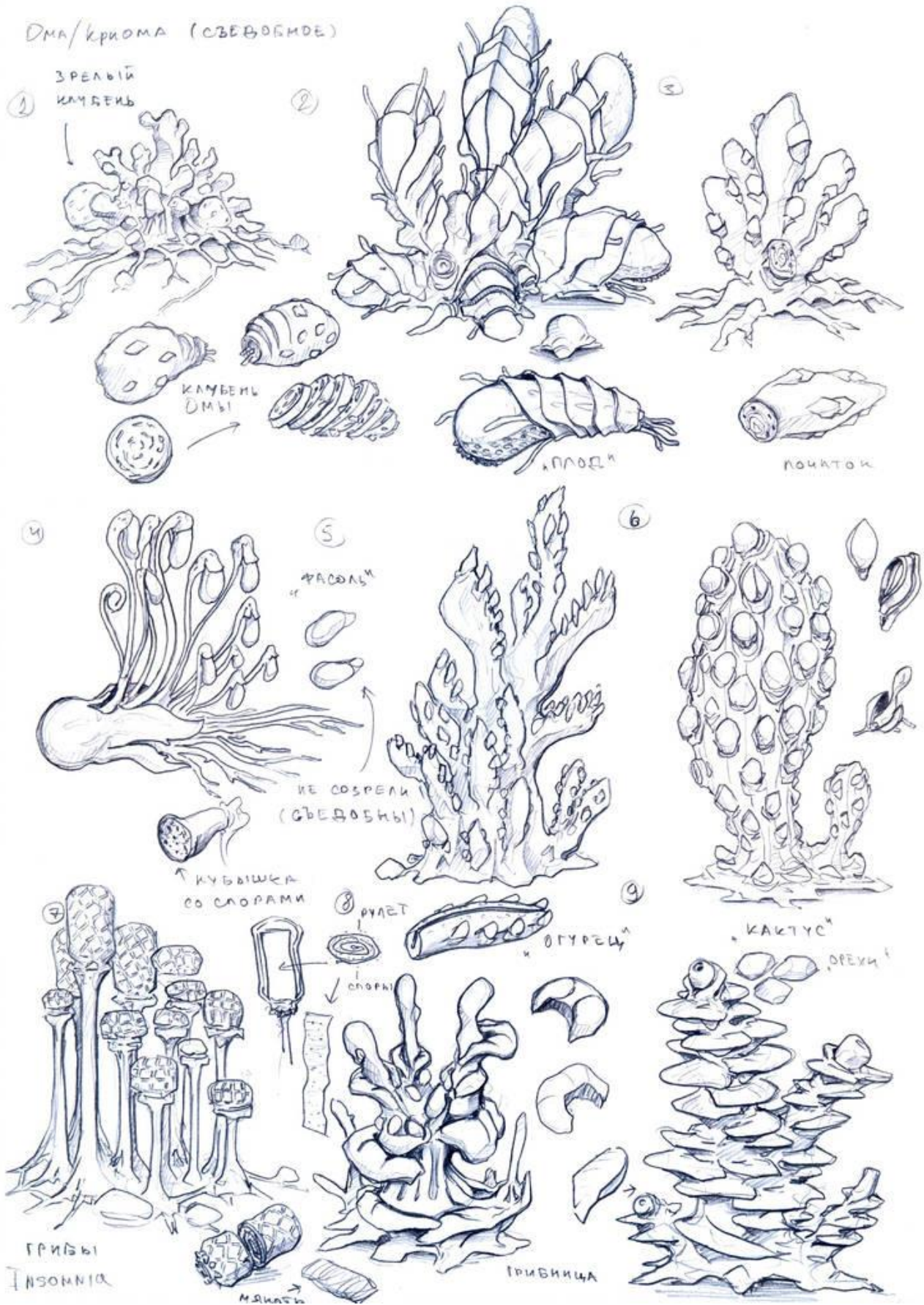

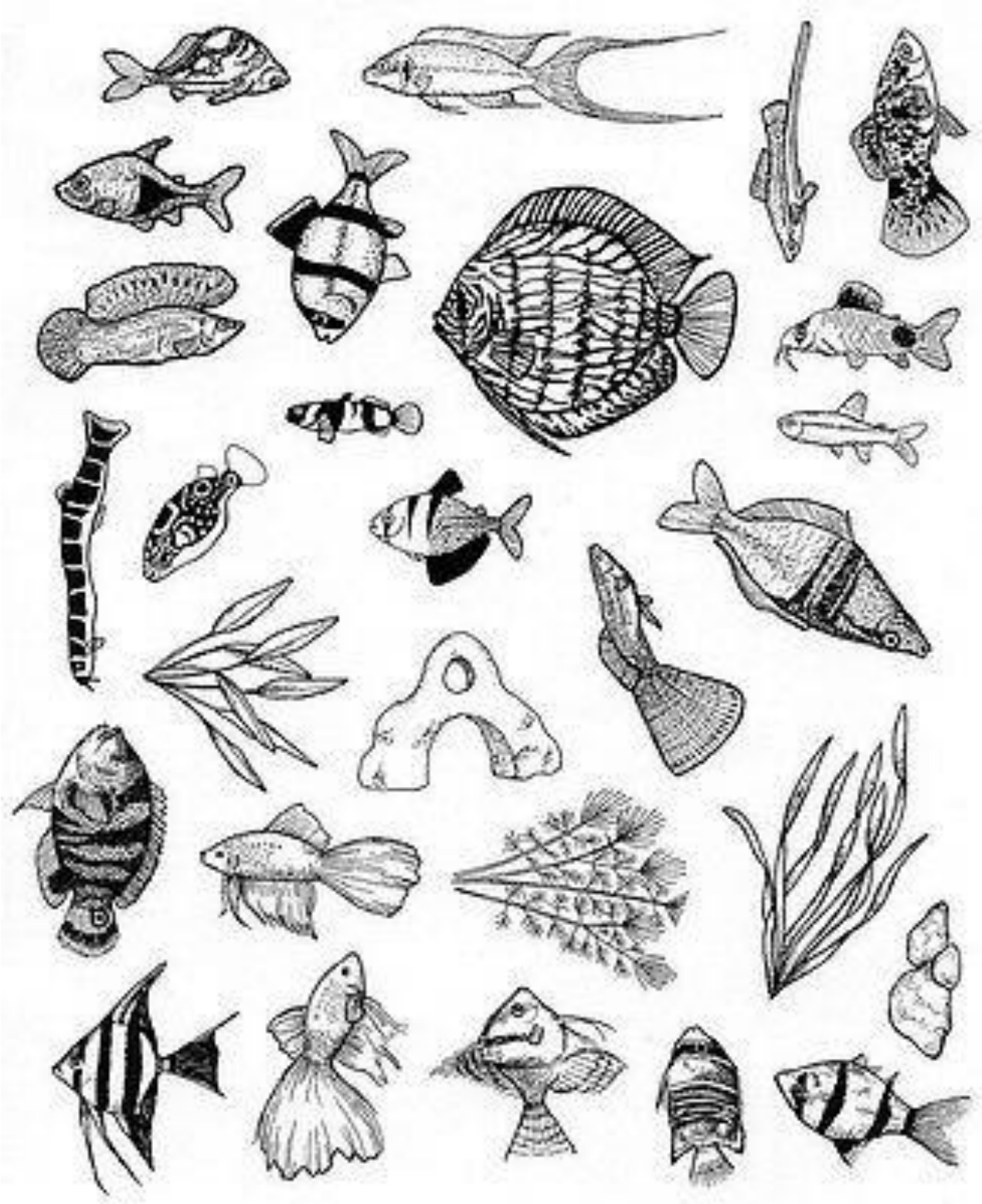





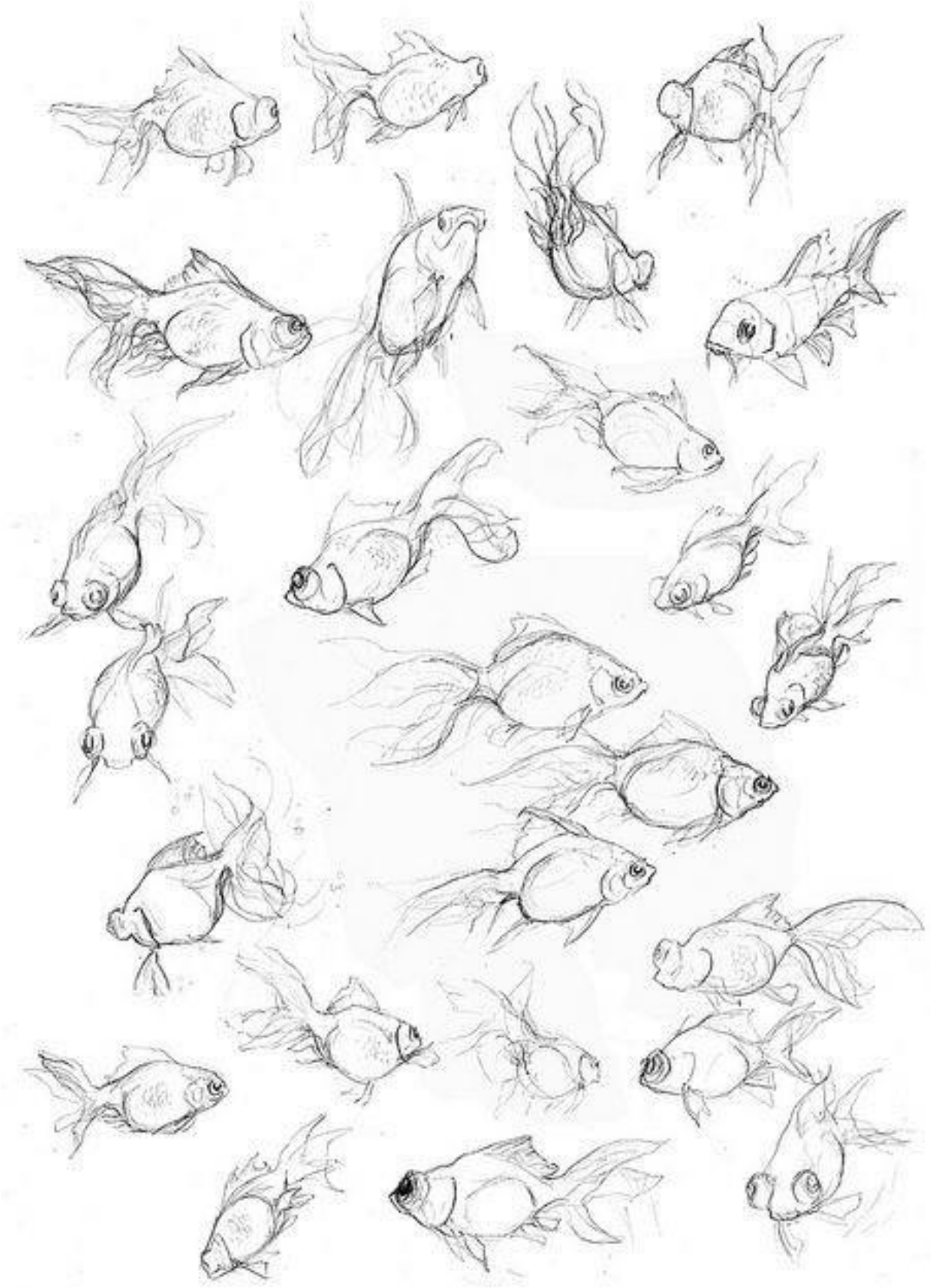

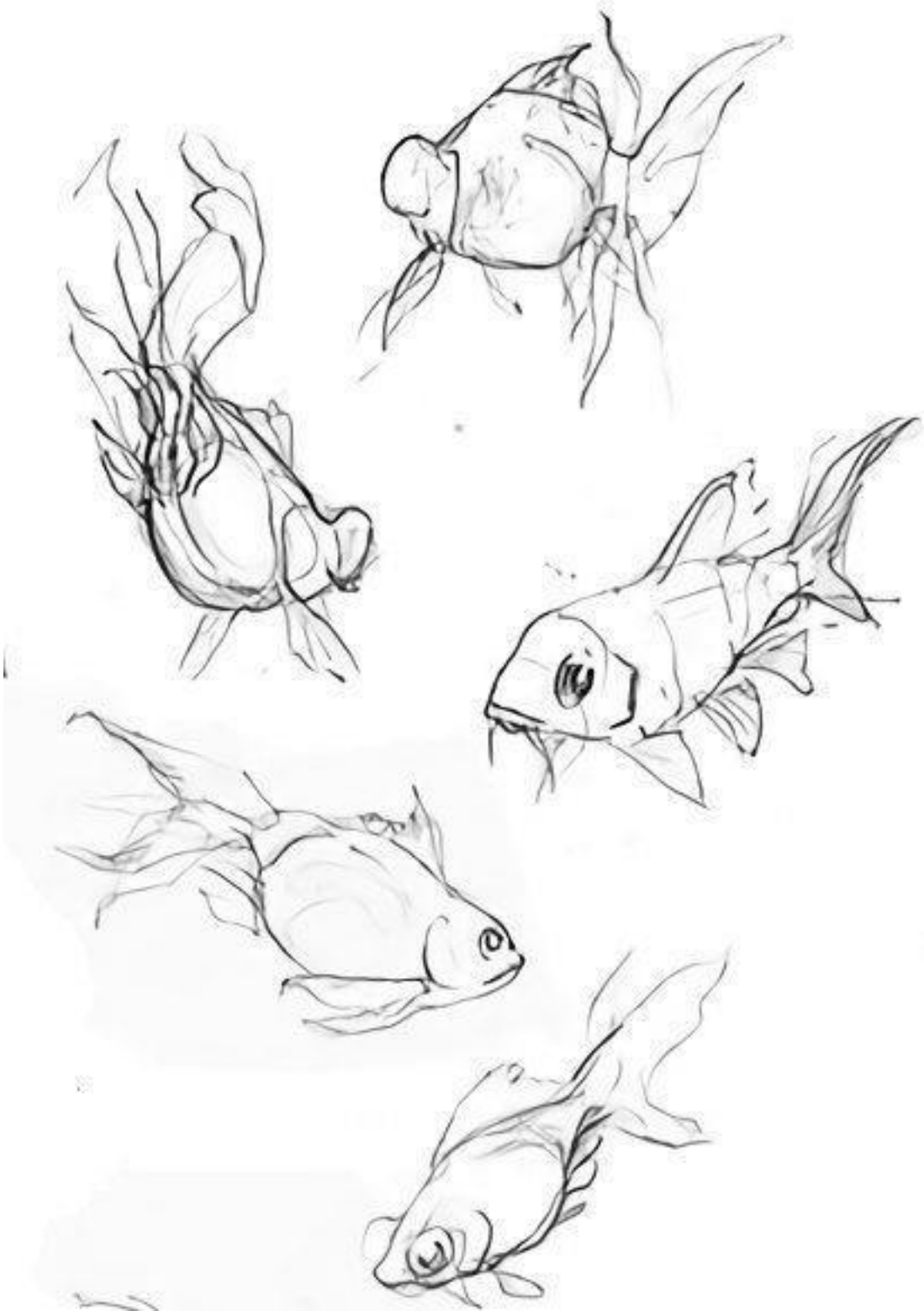

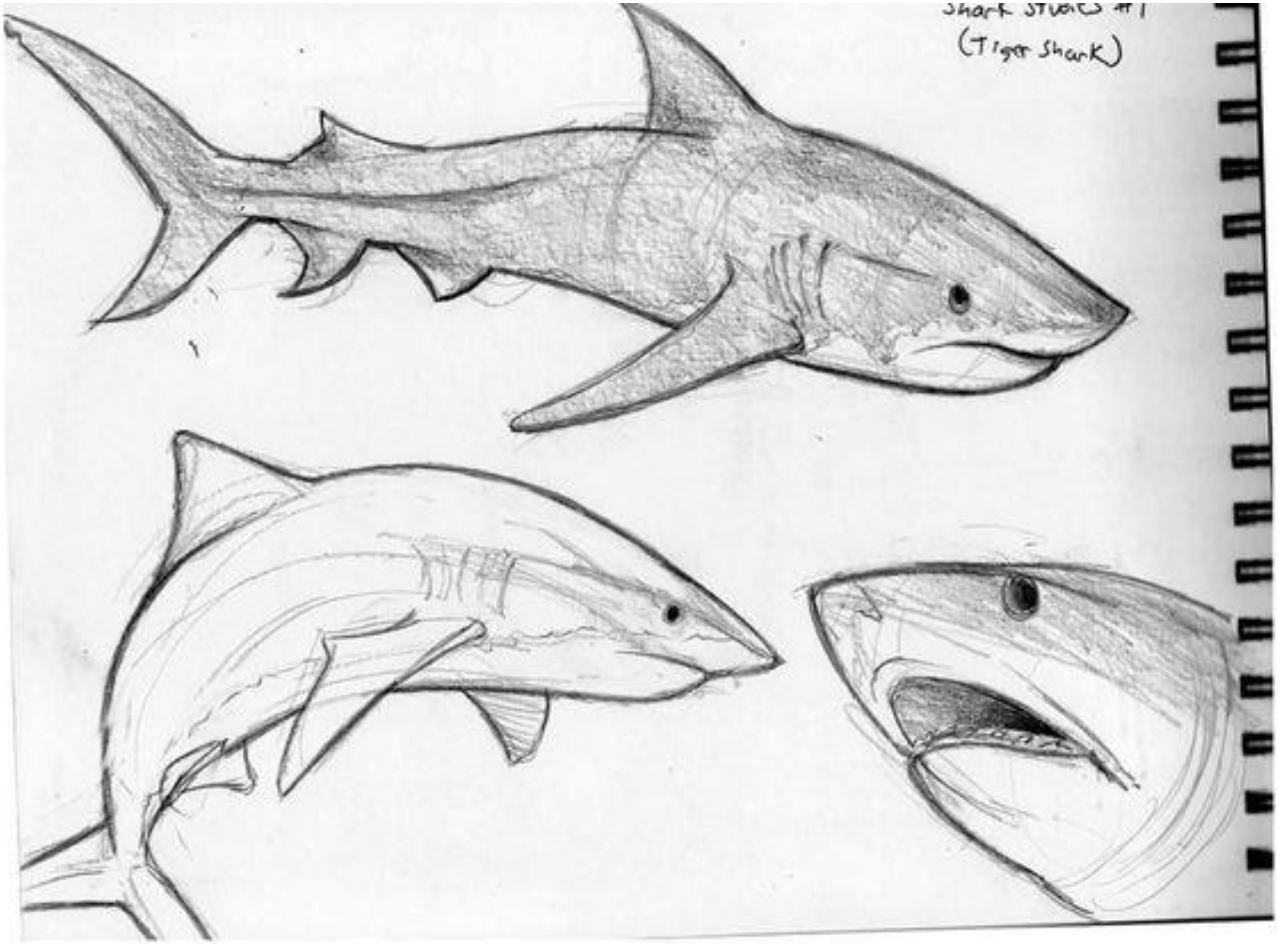

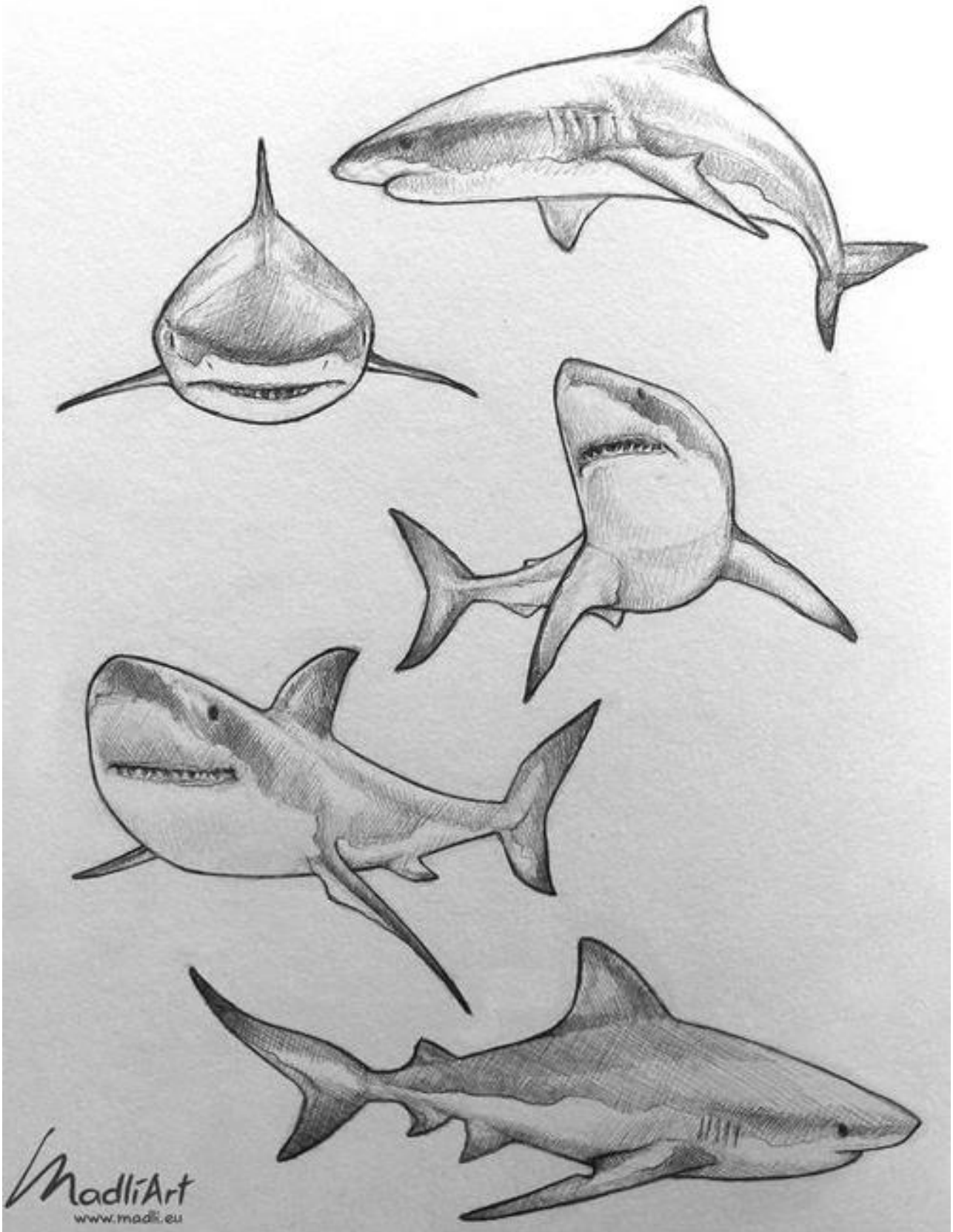

## ÖRNEK PERSPEKTİF ÇİZİMLERİ

A- Figür Ve Mekanların Perspektife Göre Çizimi

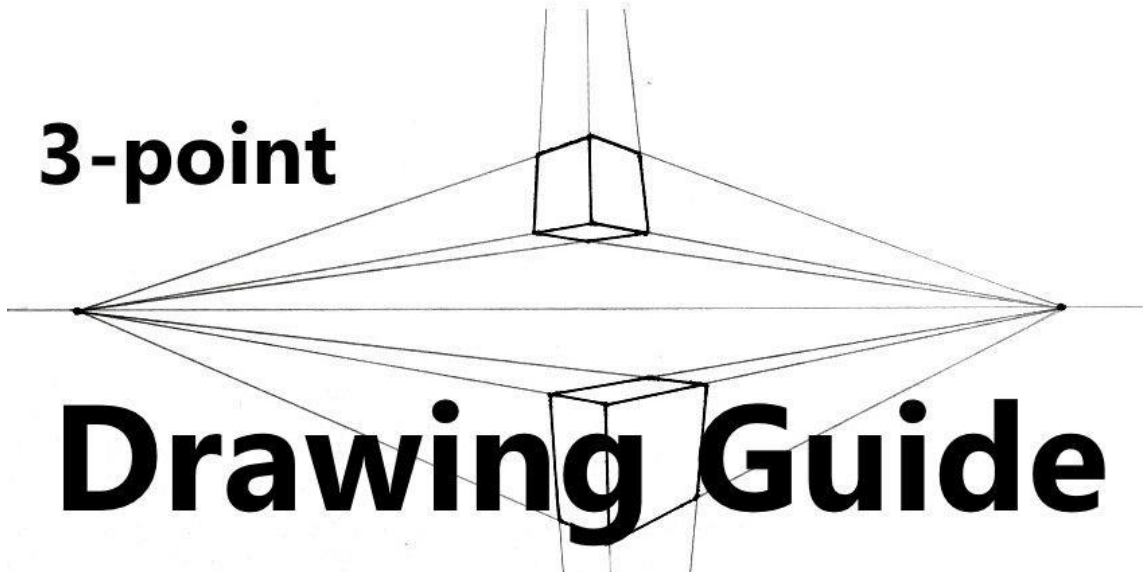
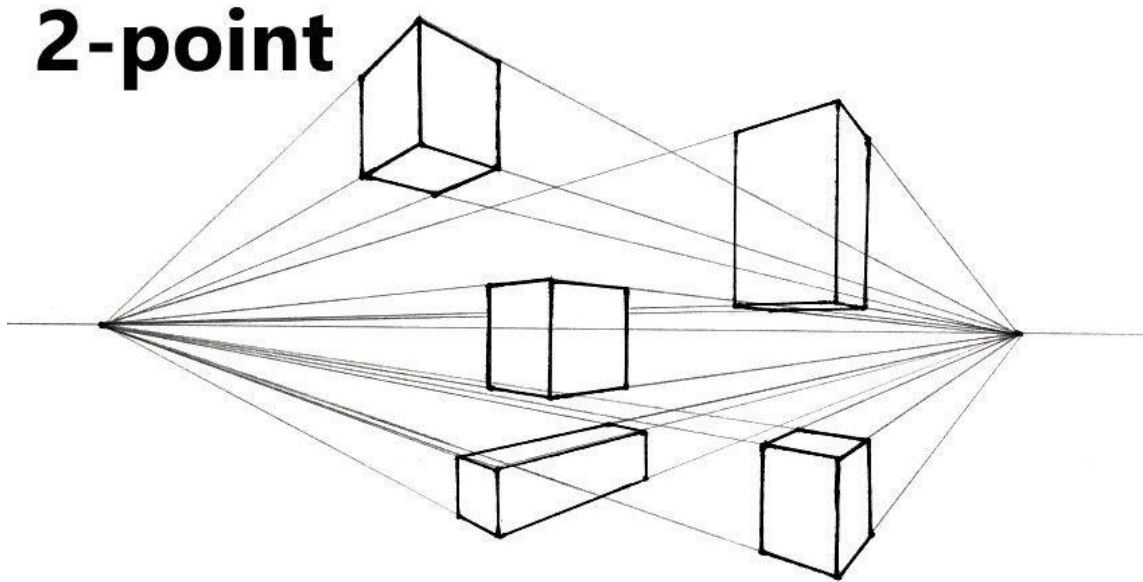
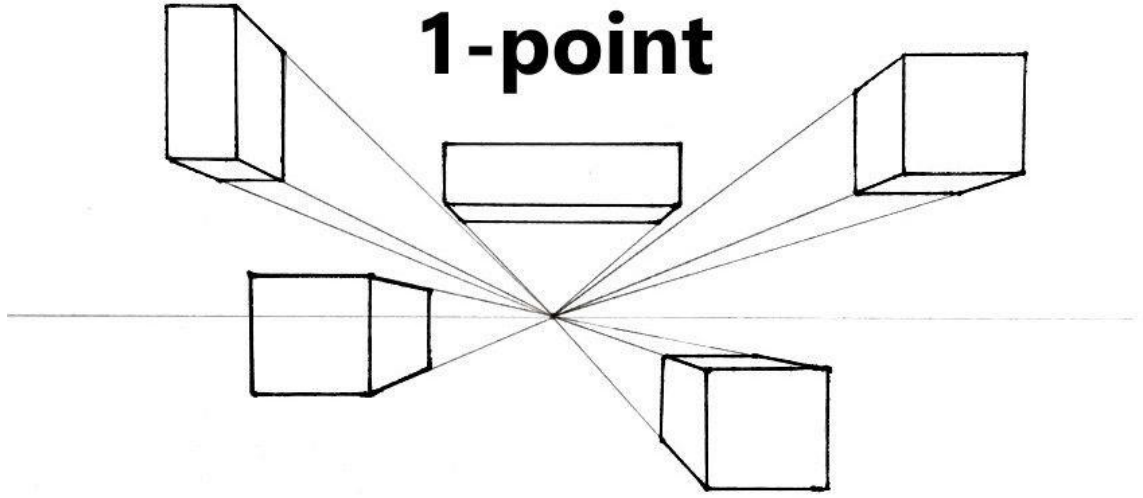

# Drawing Guide

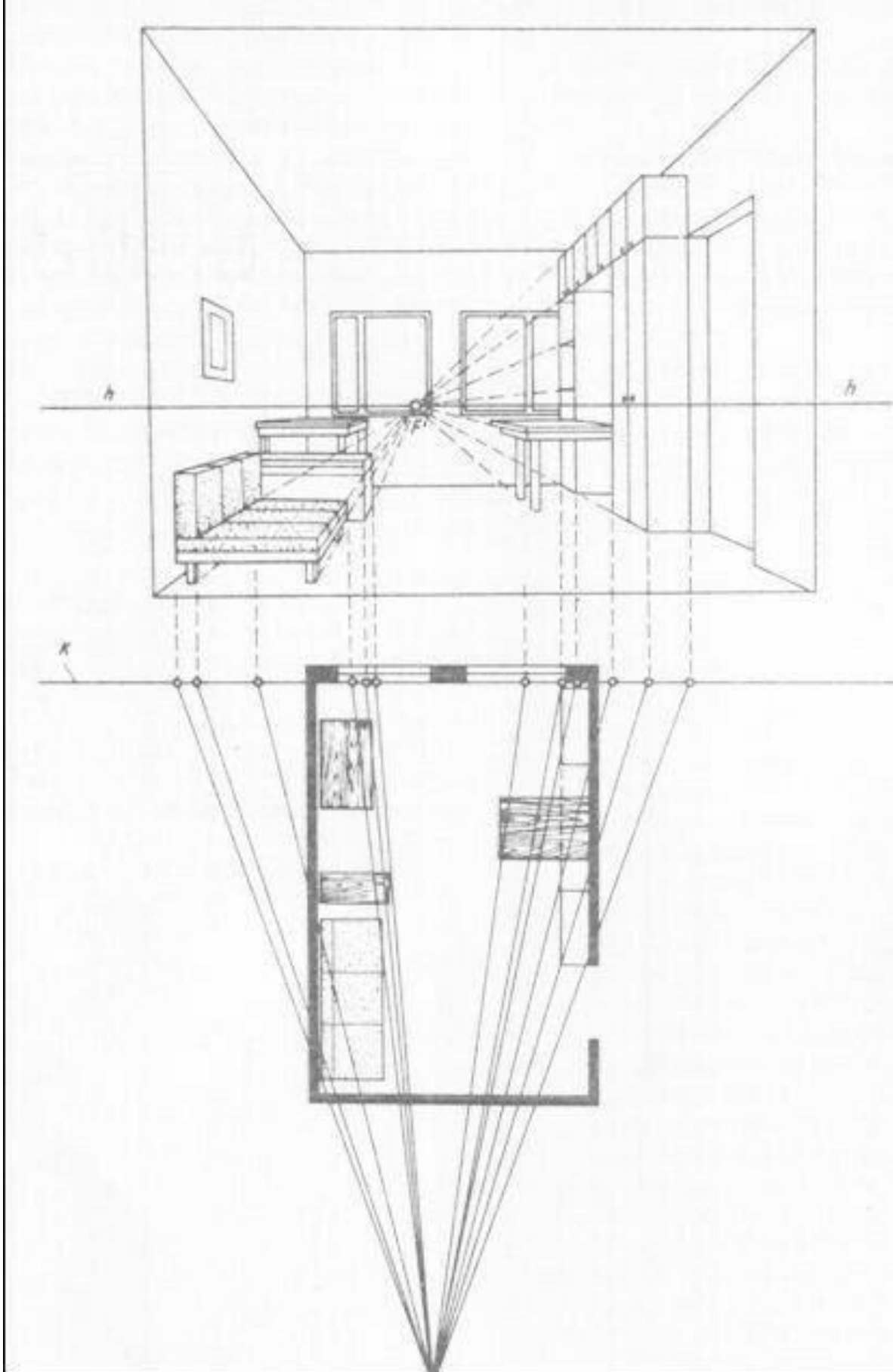

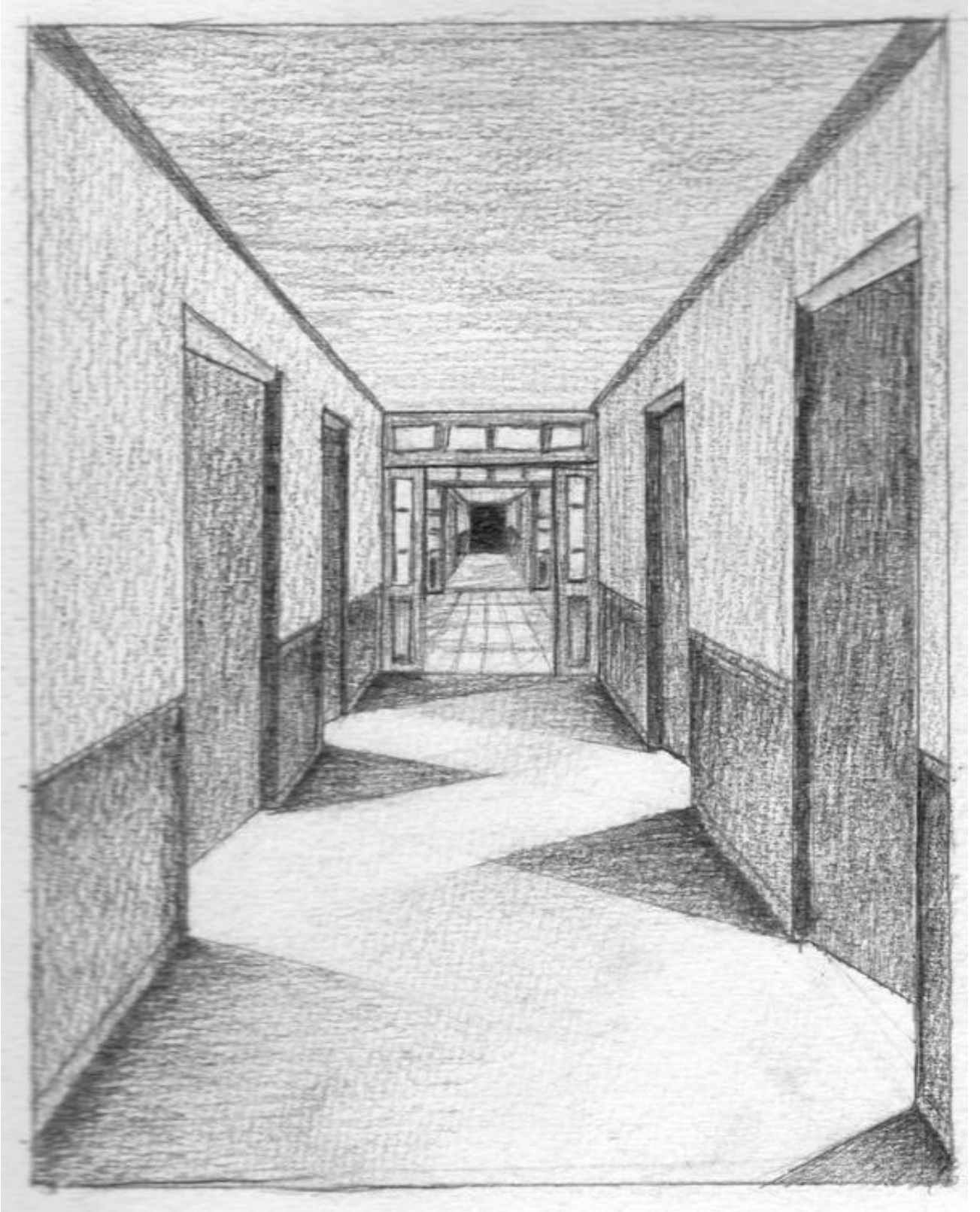



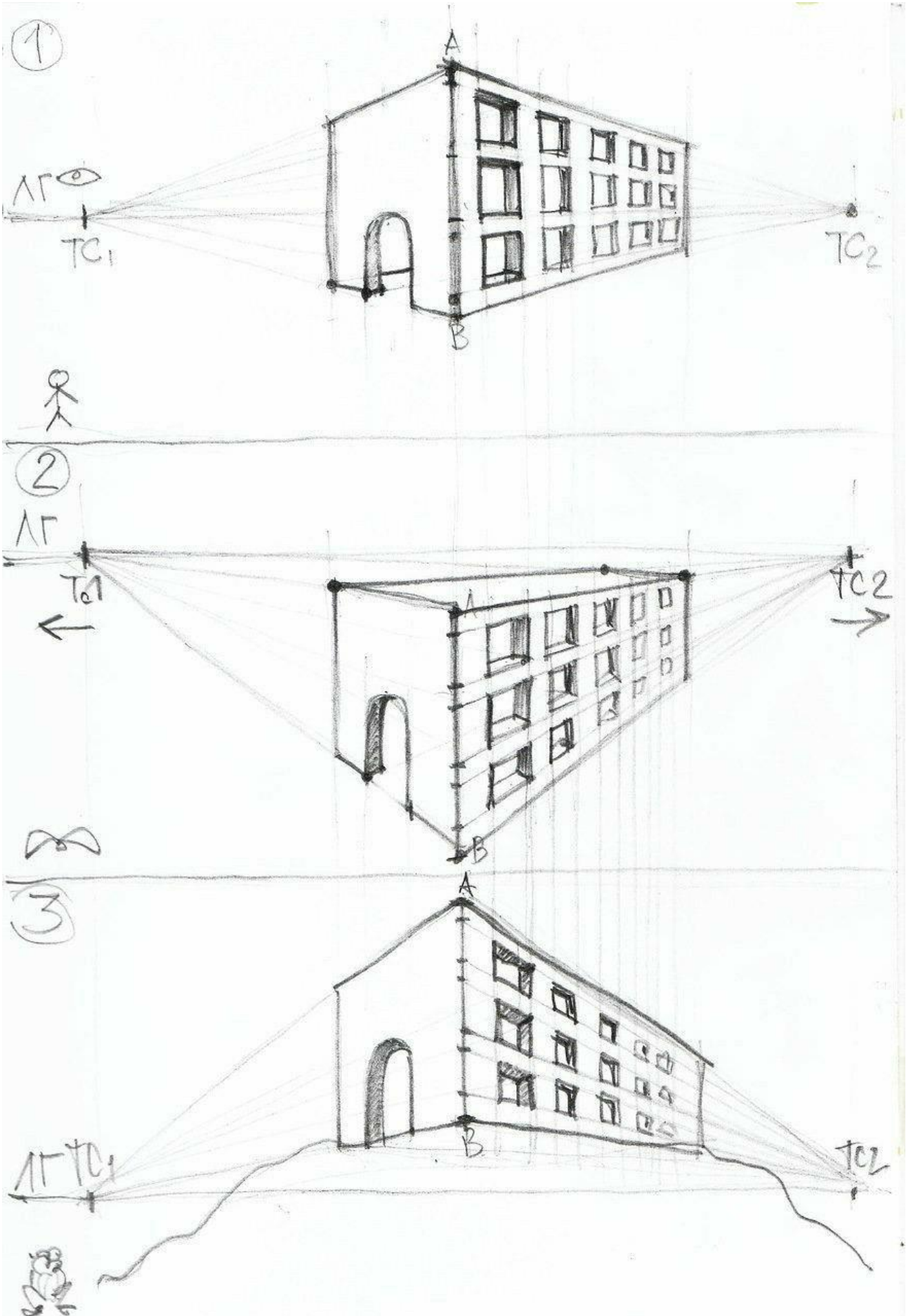

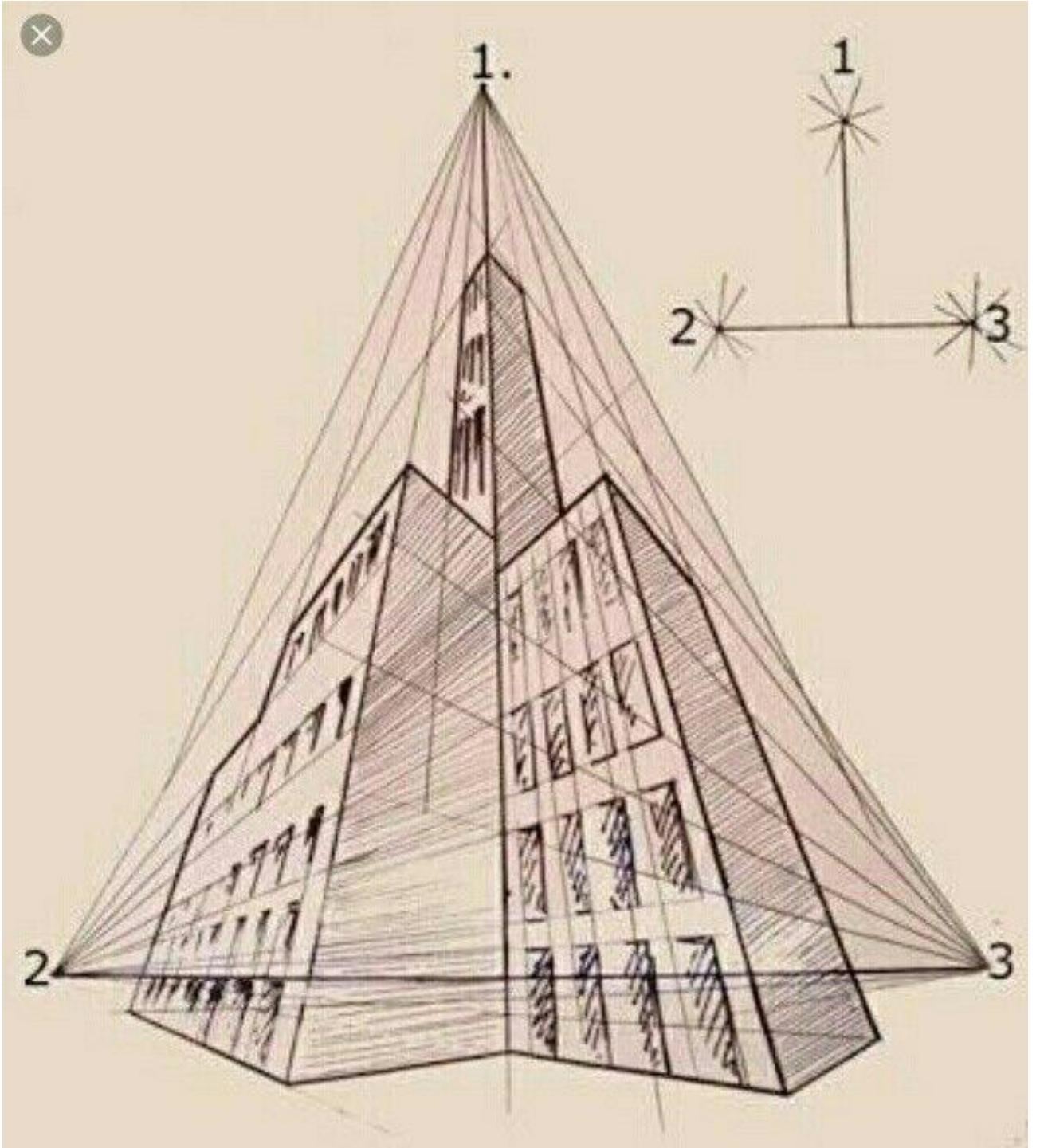

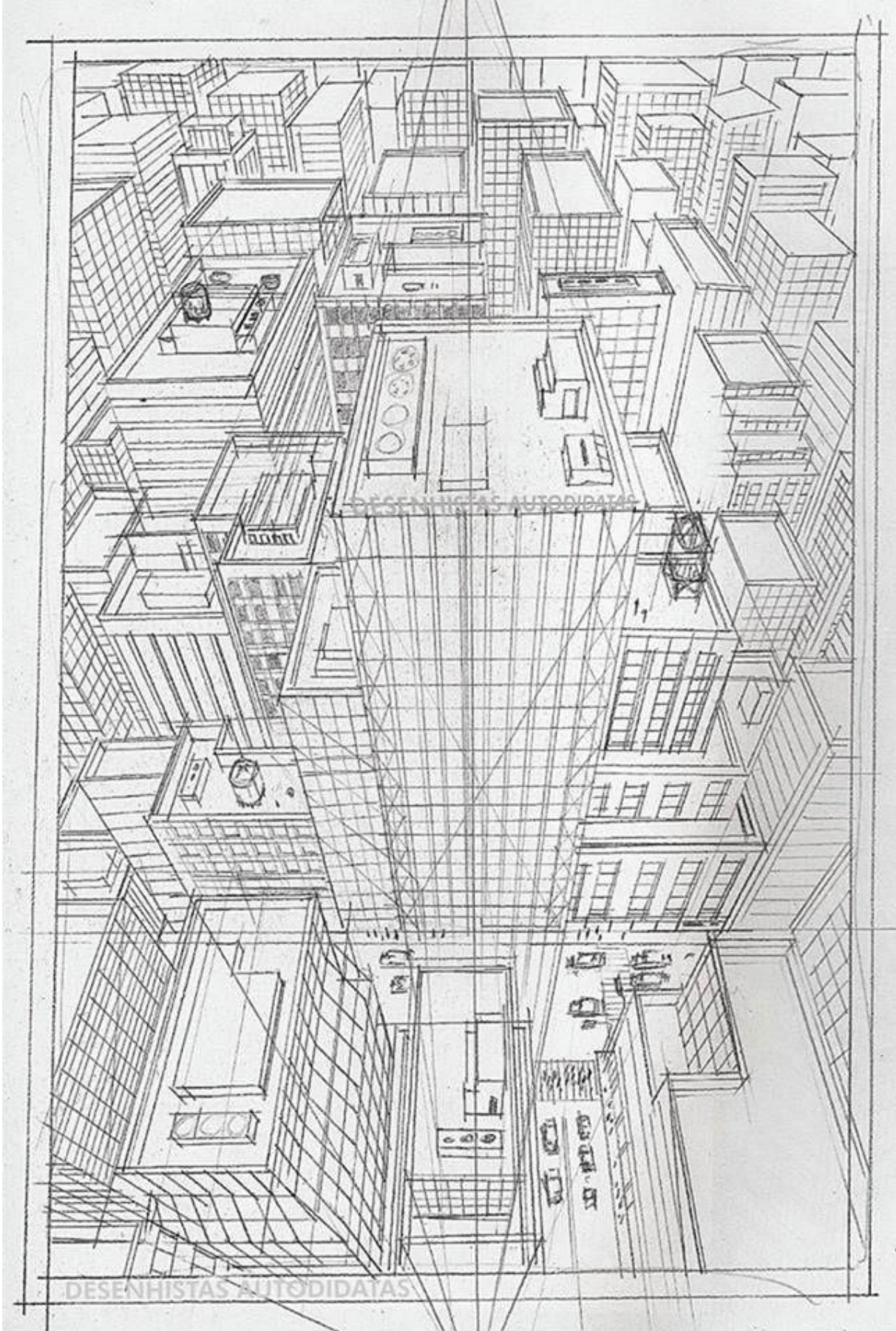

## ふたりの立ち位置と遠近法

### 一点透視図法で描く

キャラクターが手前・奥など、どの立ち位置に居ても身長差をキープしながら描くことができる

この一点から放射状にガイド線を描いていく

消失点

身長差を表した長方形の四隅を同一放射線内で再現すれば、手前・奥に居ても身長差を再現できる

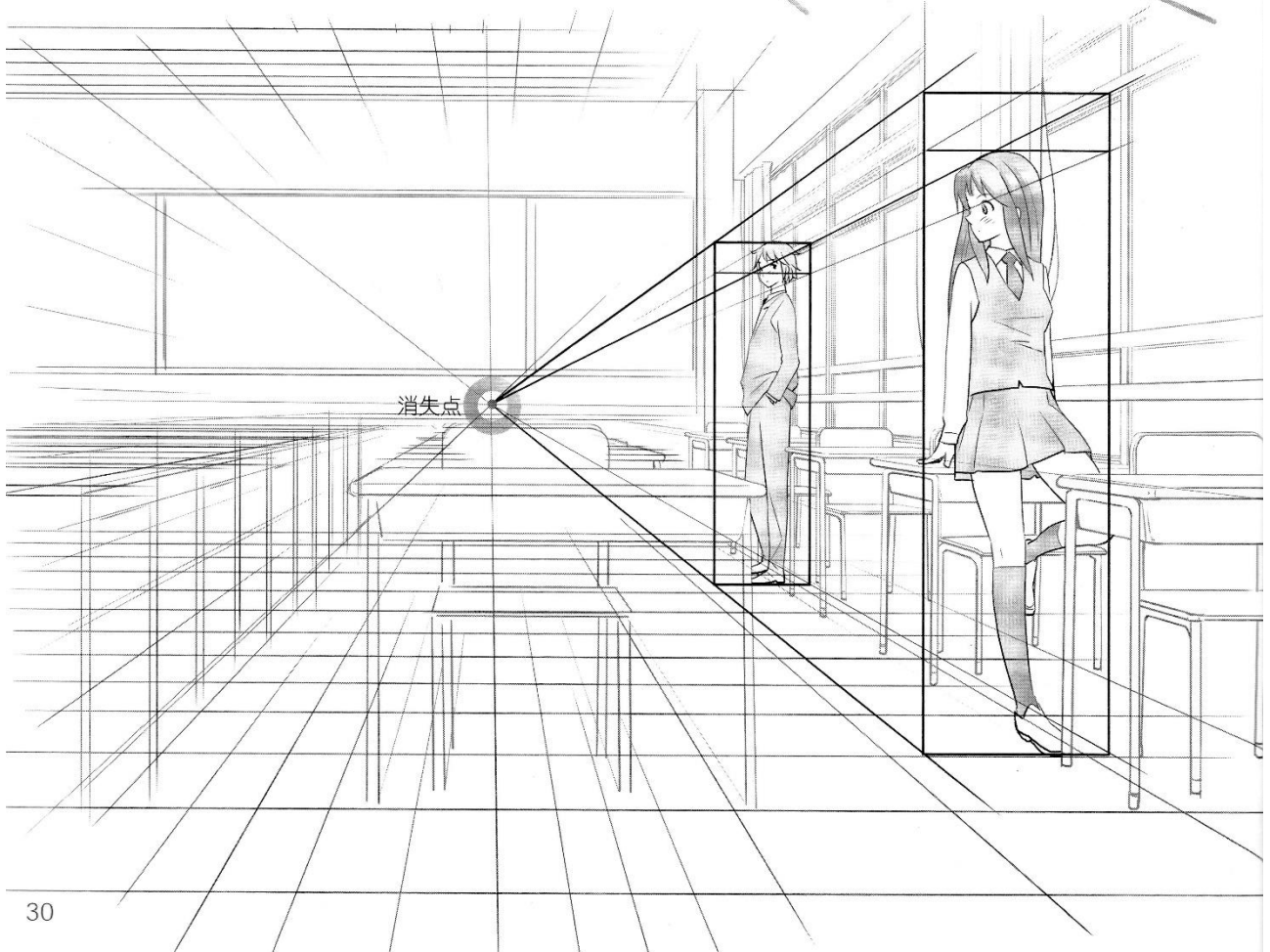
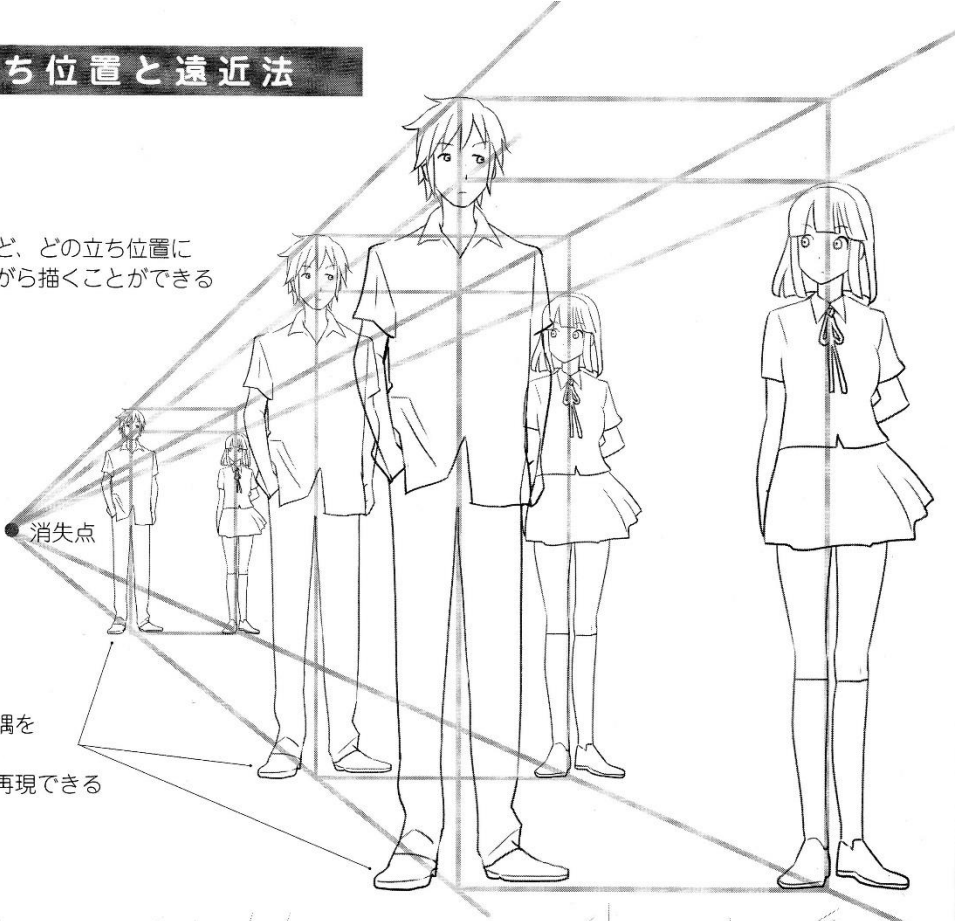

## PERSPECTIVE IN THE FIGURE

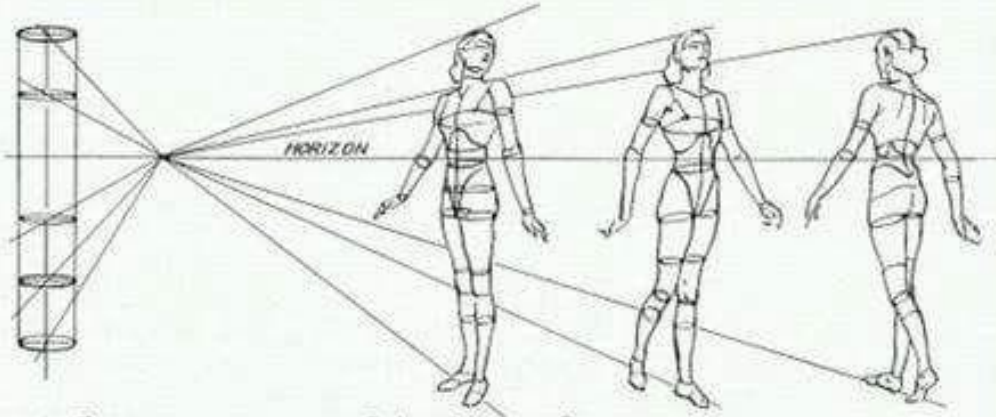

*Cylinders in Perspective*

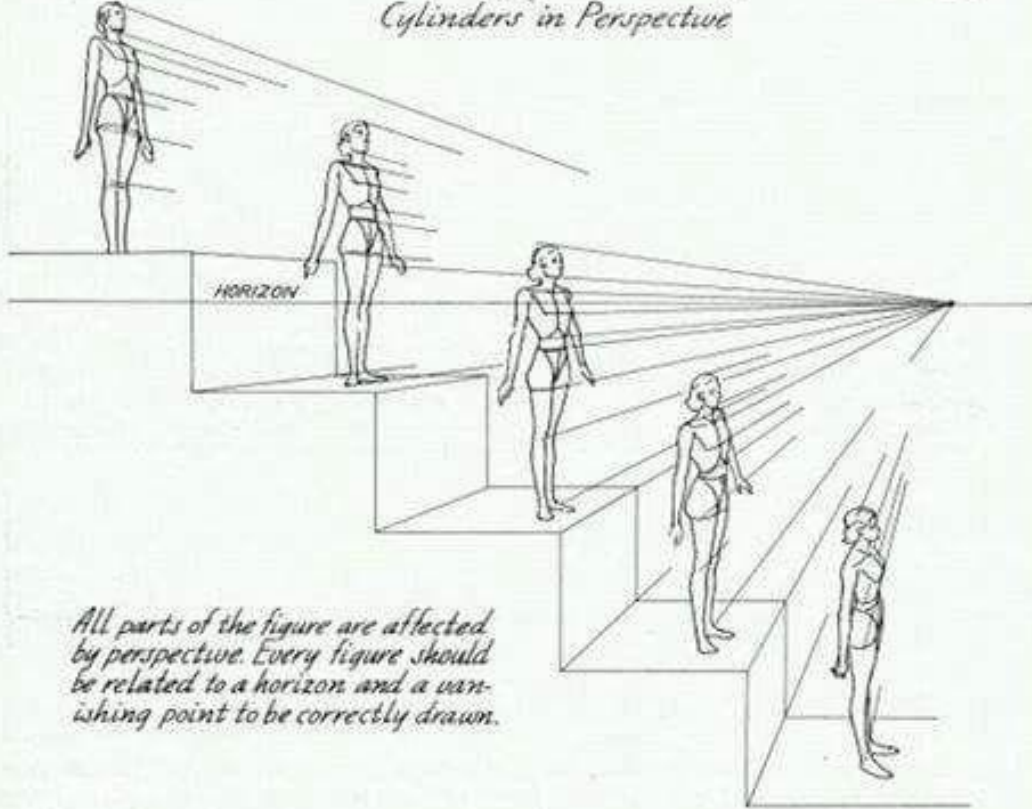

*All parts of the figure are affected by perspective. Every figure should be related to a horizon and a vanishing point to be correctly drawn.*

### PERSPECTIVE IN THE FIGURE

No matter how much you know of anatomy and the construction of the figure, you will not be able to draw figures from imagination until you can relate the different parts of the figure to a

horizon or eye level. Sometimes it is helpful to think of the various forms as they would appear as blocks – square instead of round. Then round them out.

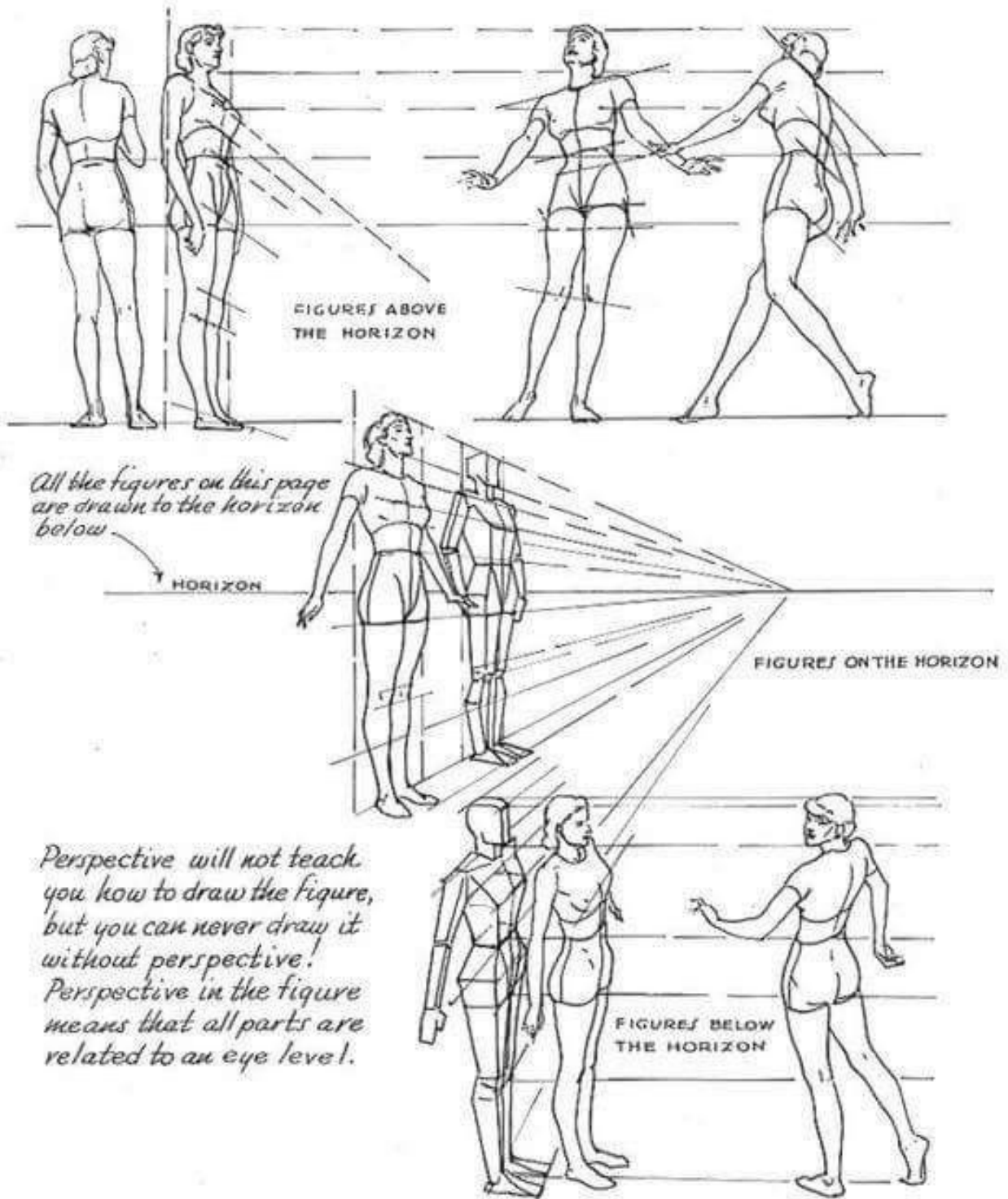

## PROPORTION IN RELATION TO THE HORIZON

How to build your picture and figures from any eyelevel (or Horizon, which means the same)

1	2	3	4	5	6
EYE LEVEL SELECTED	(HORIZON)		VP	VP	VP
Select a placement for the Horizon.	Establish height of first figure. (Any height)	Set point for feet of 2 <sup>d</sup> Figure. (Place anywhere)	Draw line through point to Horizon.	Then back to "A" of top 1st Figure	Erect perpendicular at "C". CB is 2 <sup>d</sup> Figure
Divide into 4ths.	Build figures. If you want more-	Take another point "D" thru "C" to Horizon.	Divide as you did before	Complete 3rd Fig.	Build your picture to same Horizon.

Rule: Horizon must cross all similar figures on a level plane at the same point. (above, at knees)

## HOW TO LAY OUT THUMBNAIL SKETCHES FOR FIGURE PLACEMENTS AND SIZES

From one figure you can get any number	Take a little off for a woman's figure	

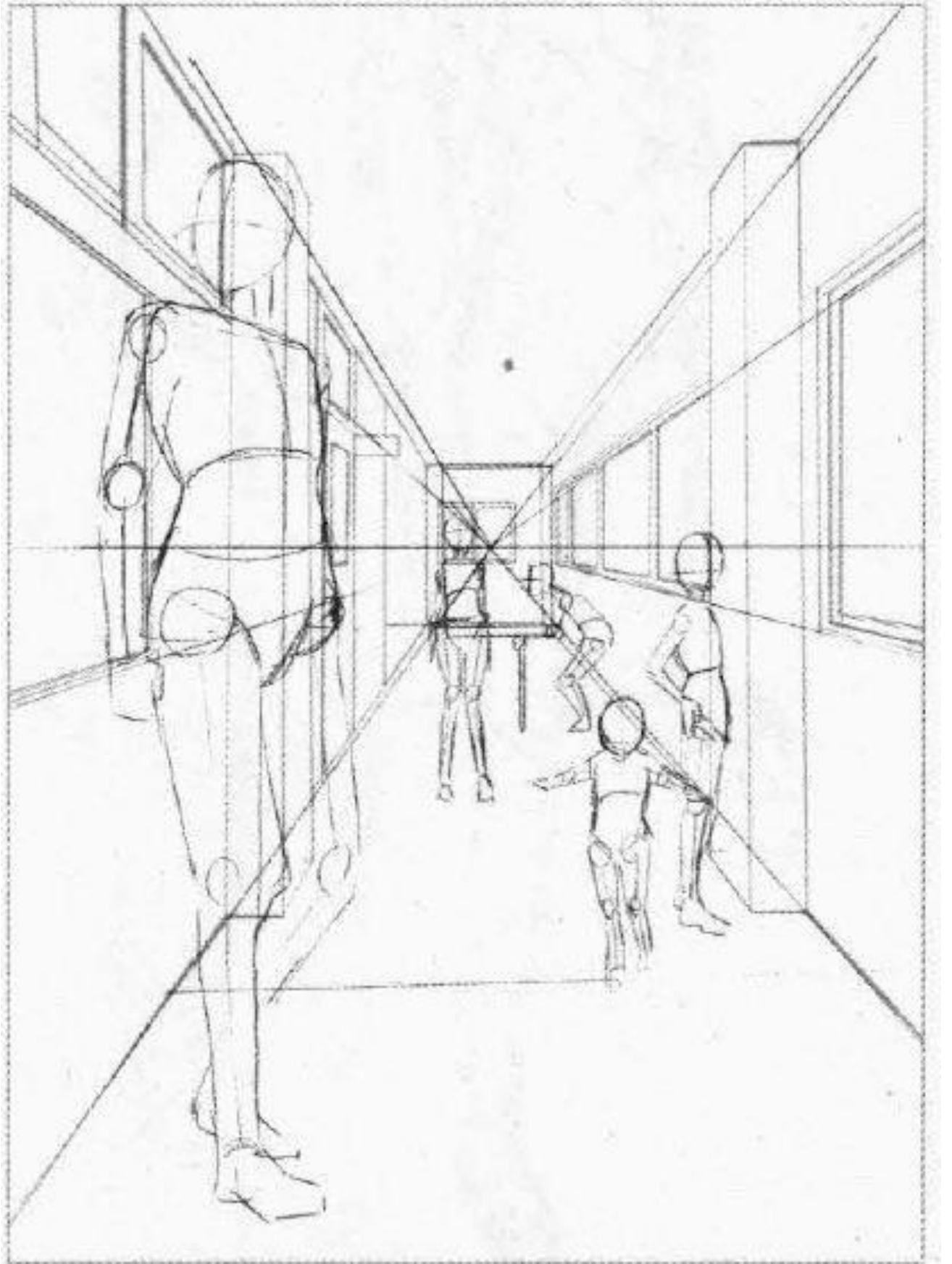



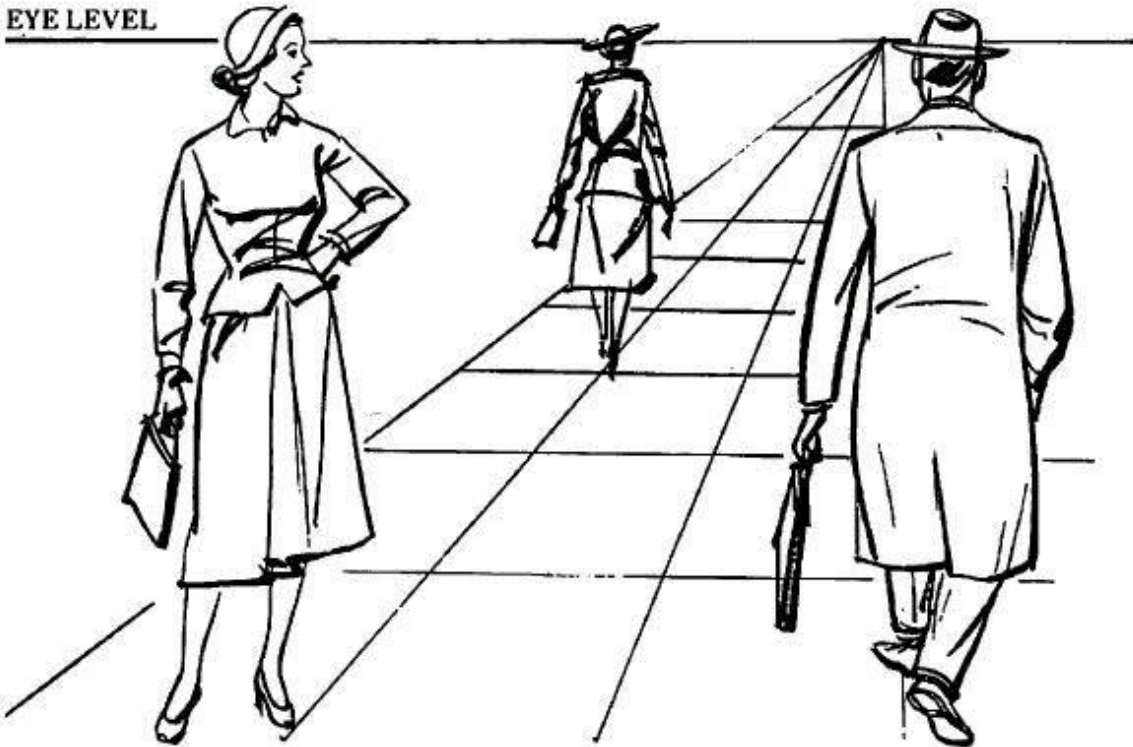
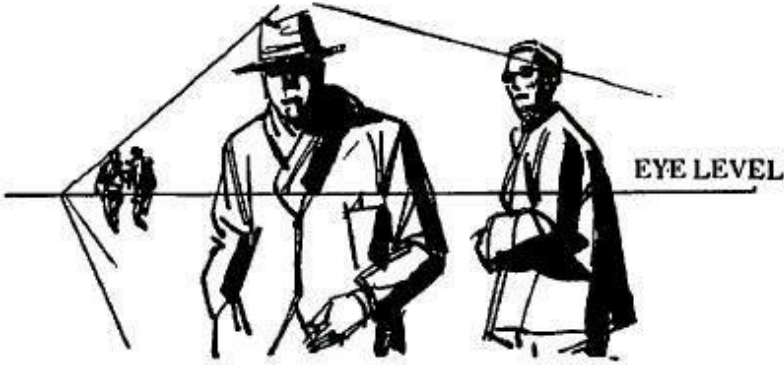
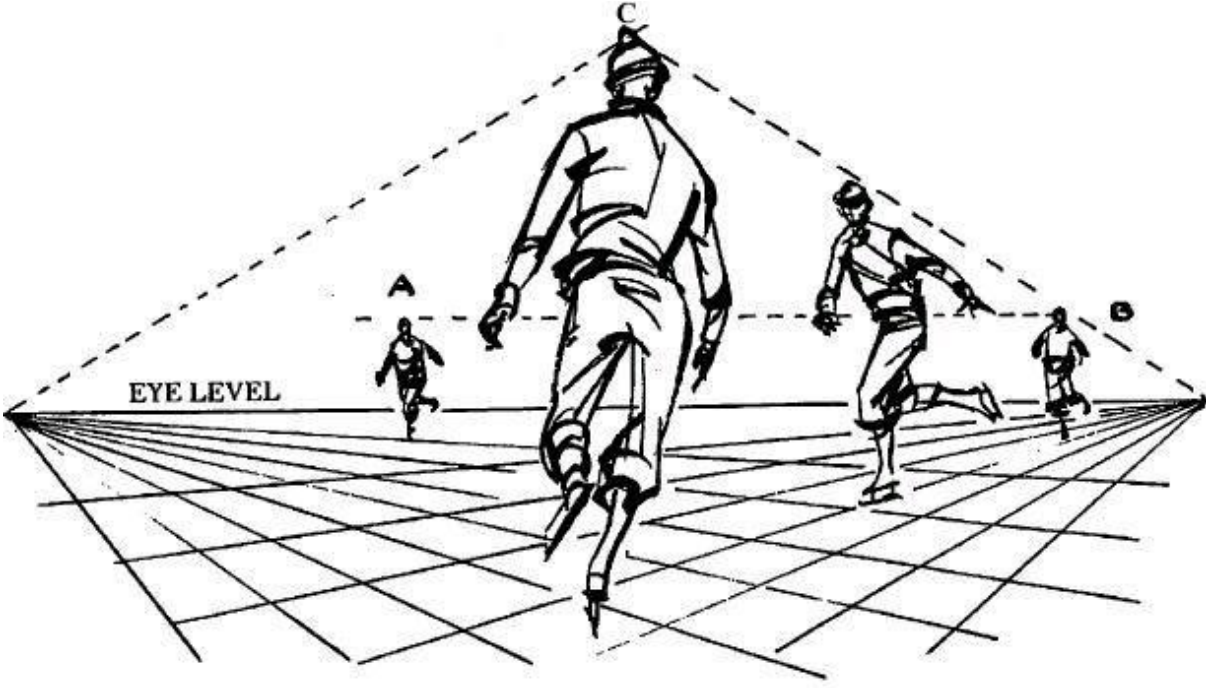

◆用三点透视法和台阶的火点来处理画面



水平线

画面左下方的灭点，为这个画面带来了进深效果。  
位于右侧的灭点设定得较远，从而产生了几乎平行且间距很近的线。这些都是为了不使画面造成不自然的歪斜感。

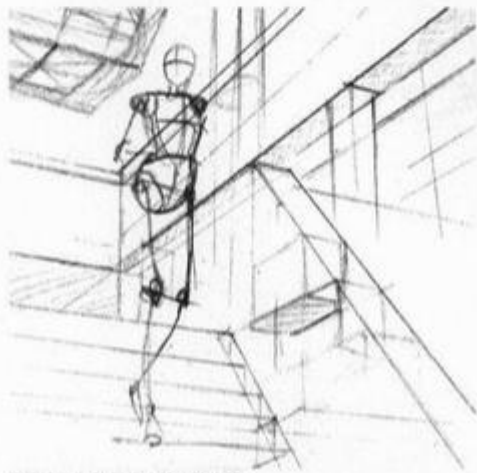

素描人物与简单化了的立体表现



将柱子的棱角放在正面，从而增强了它的高档感。



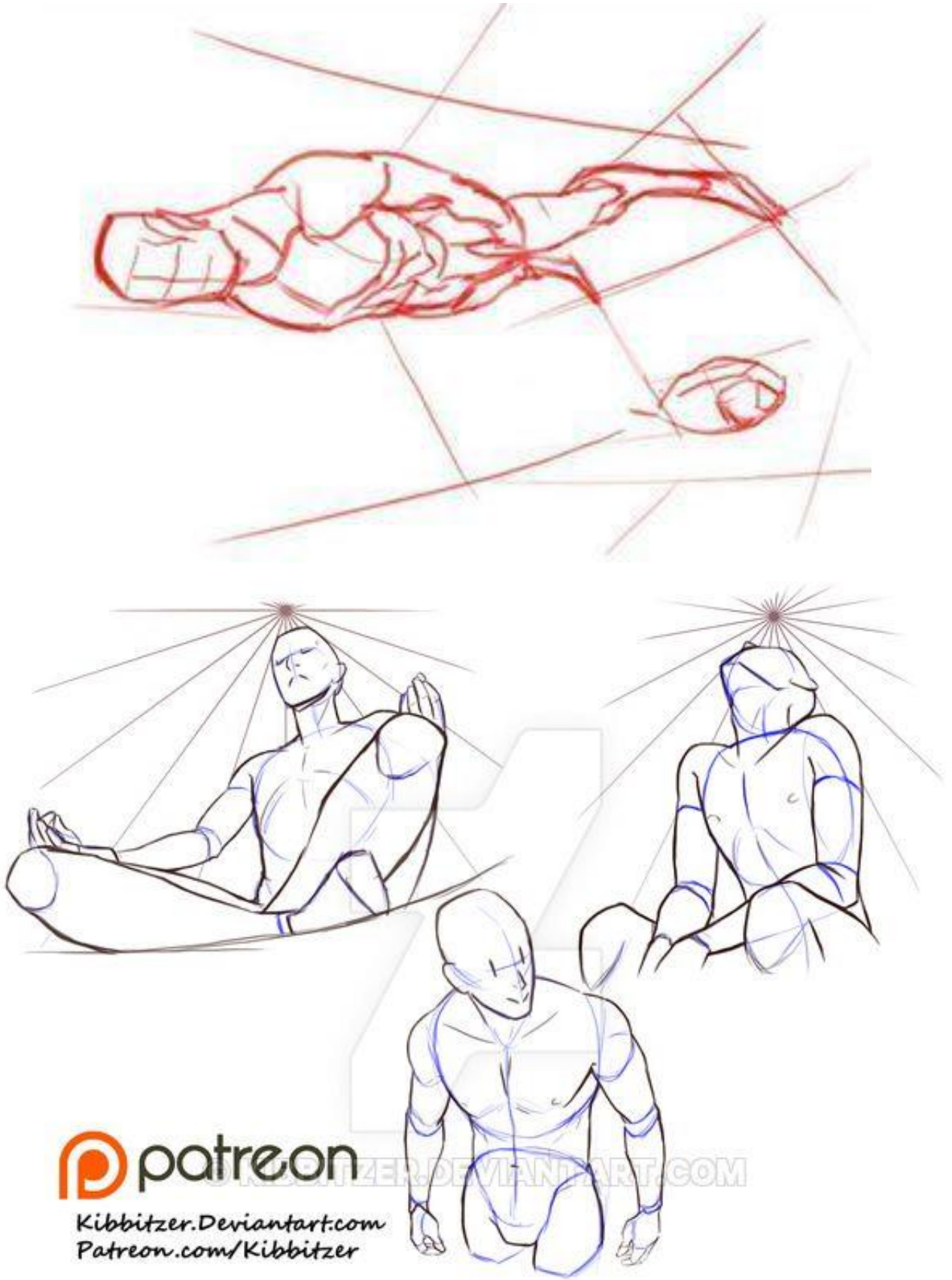





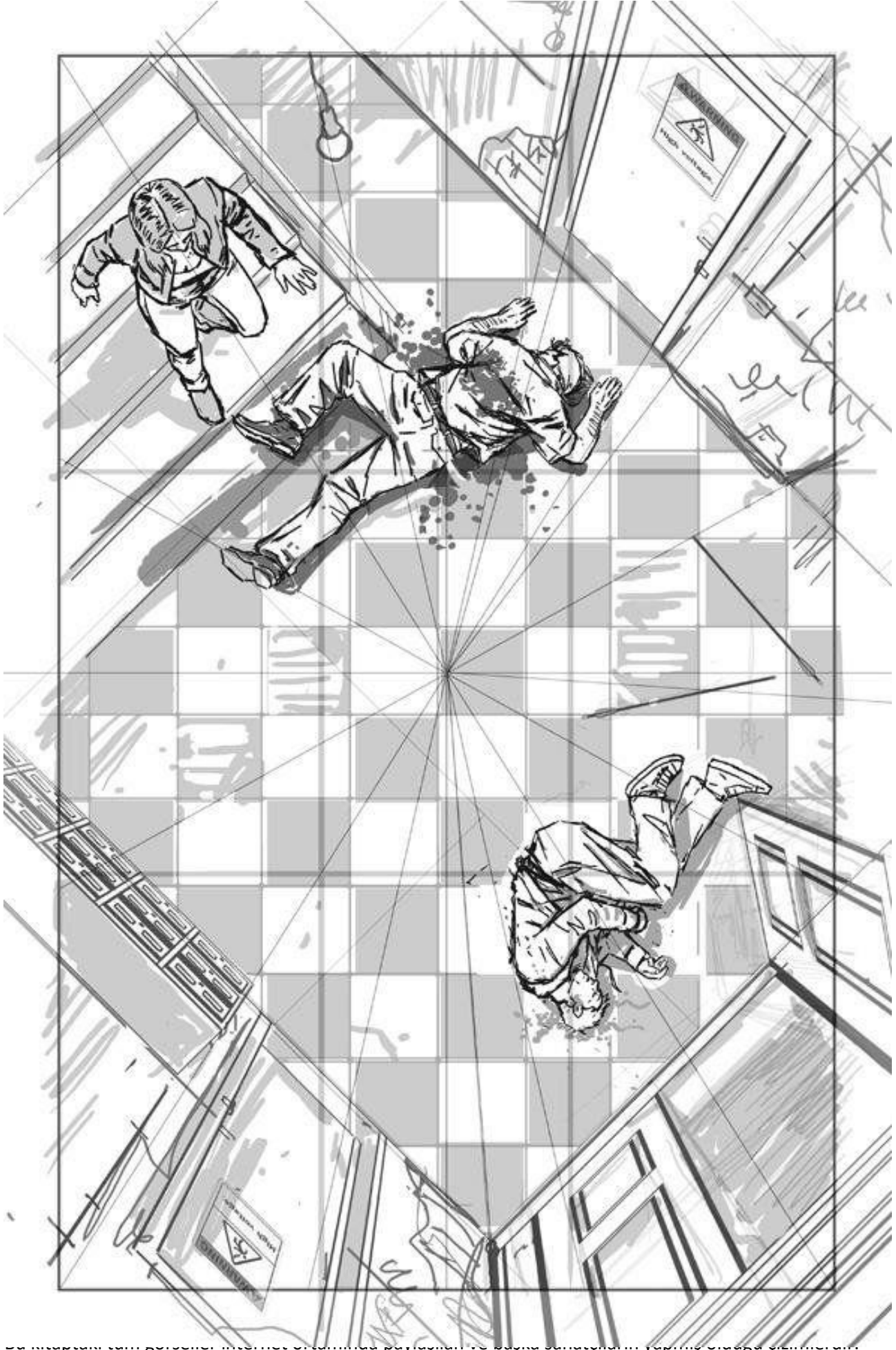







B- Işık Kaynağının Perspektife Göre Çizimi

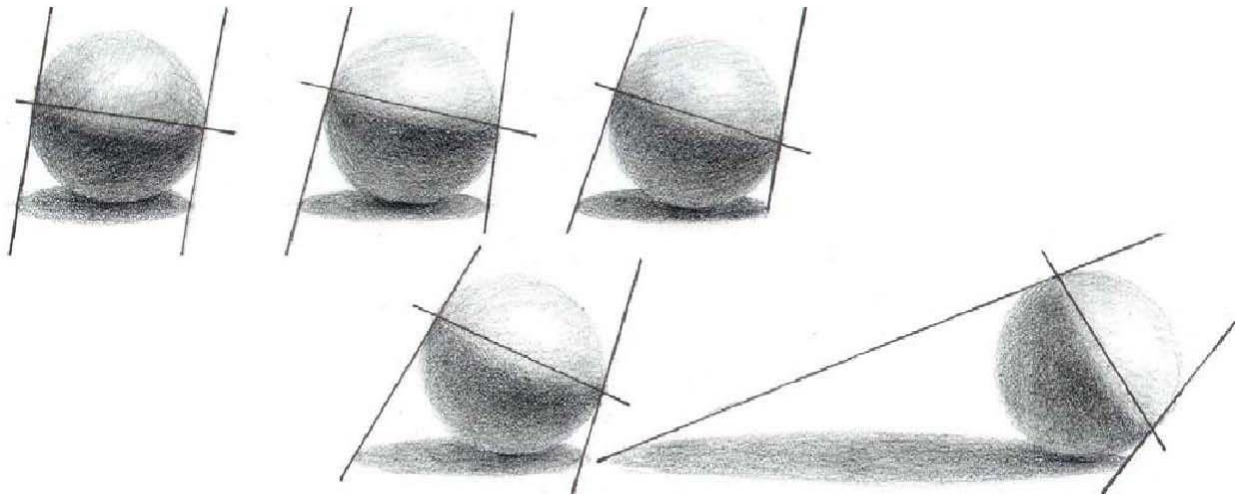
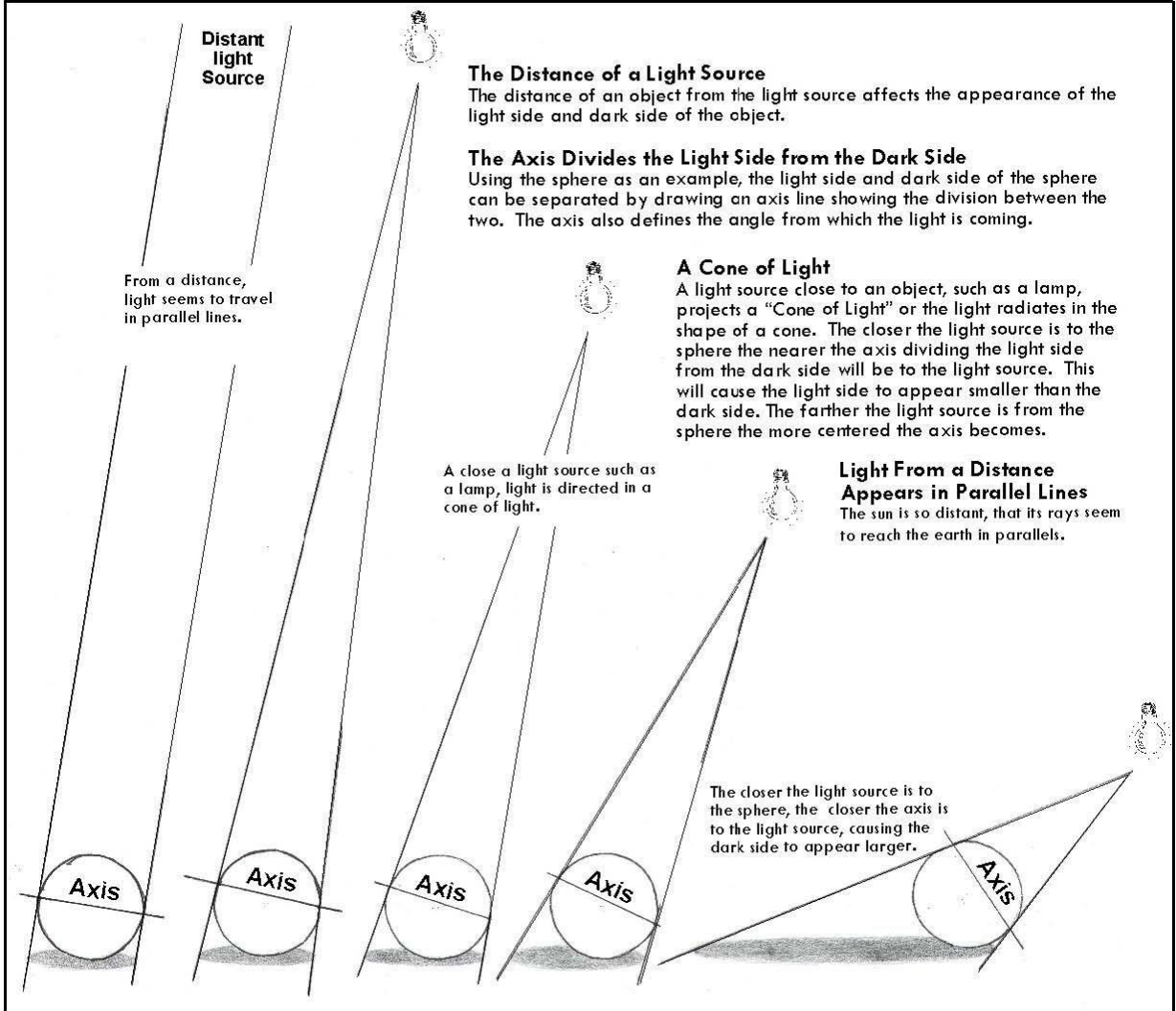

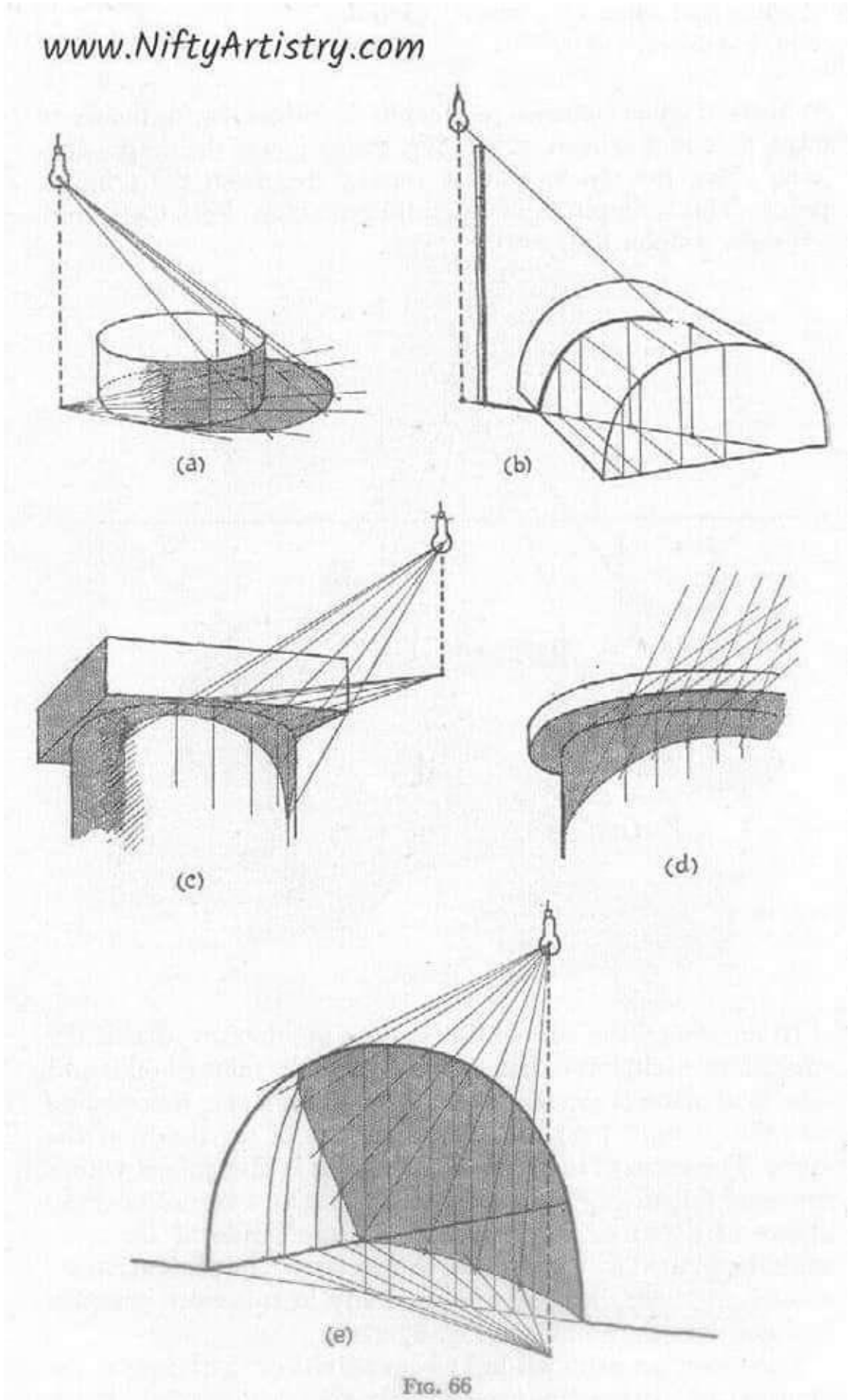

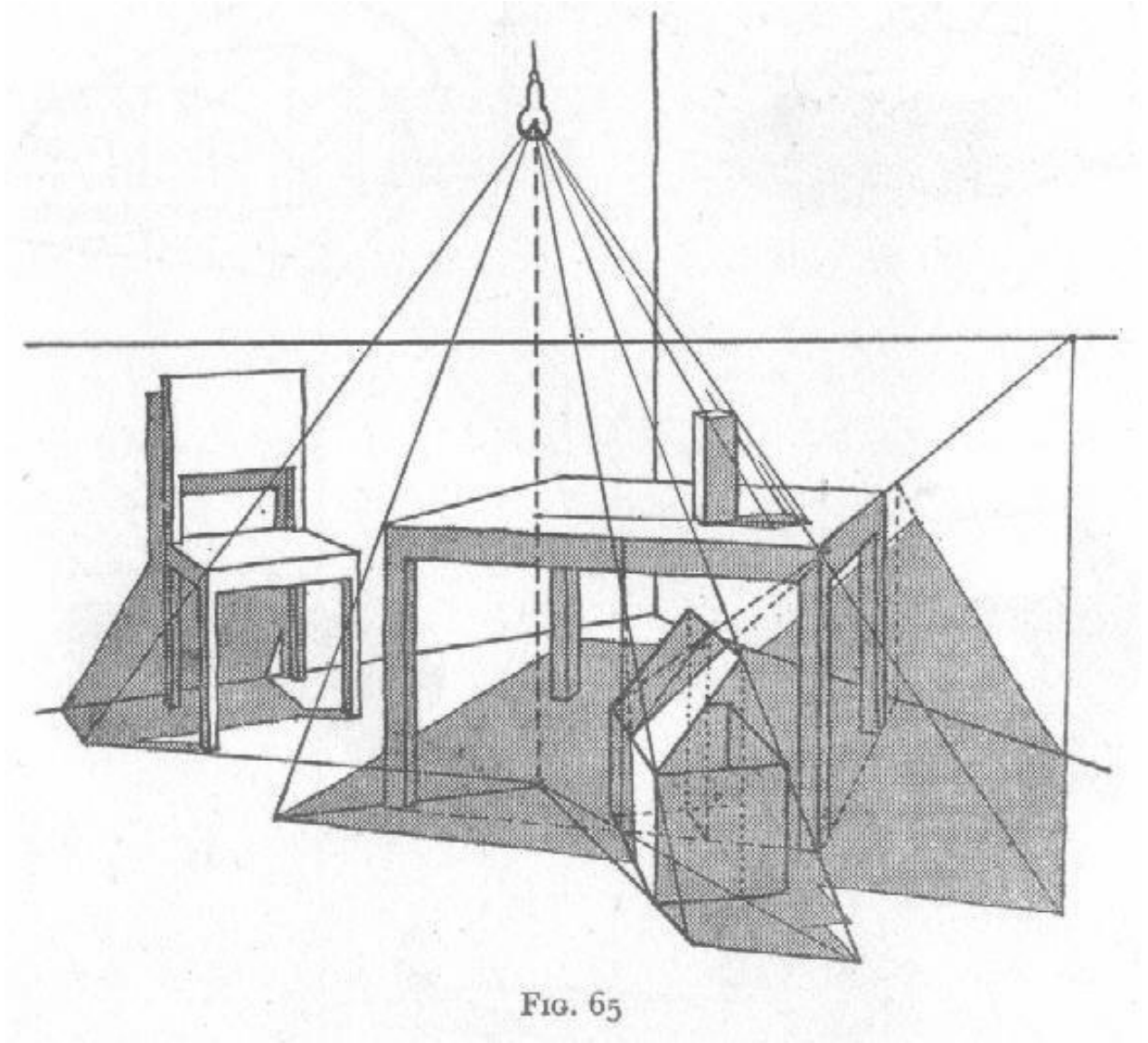

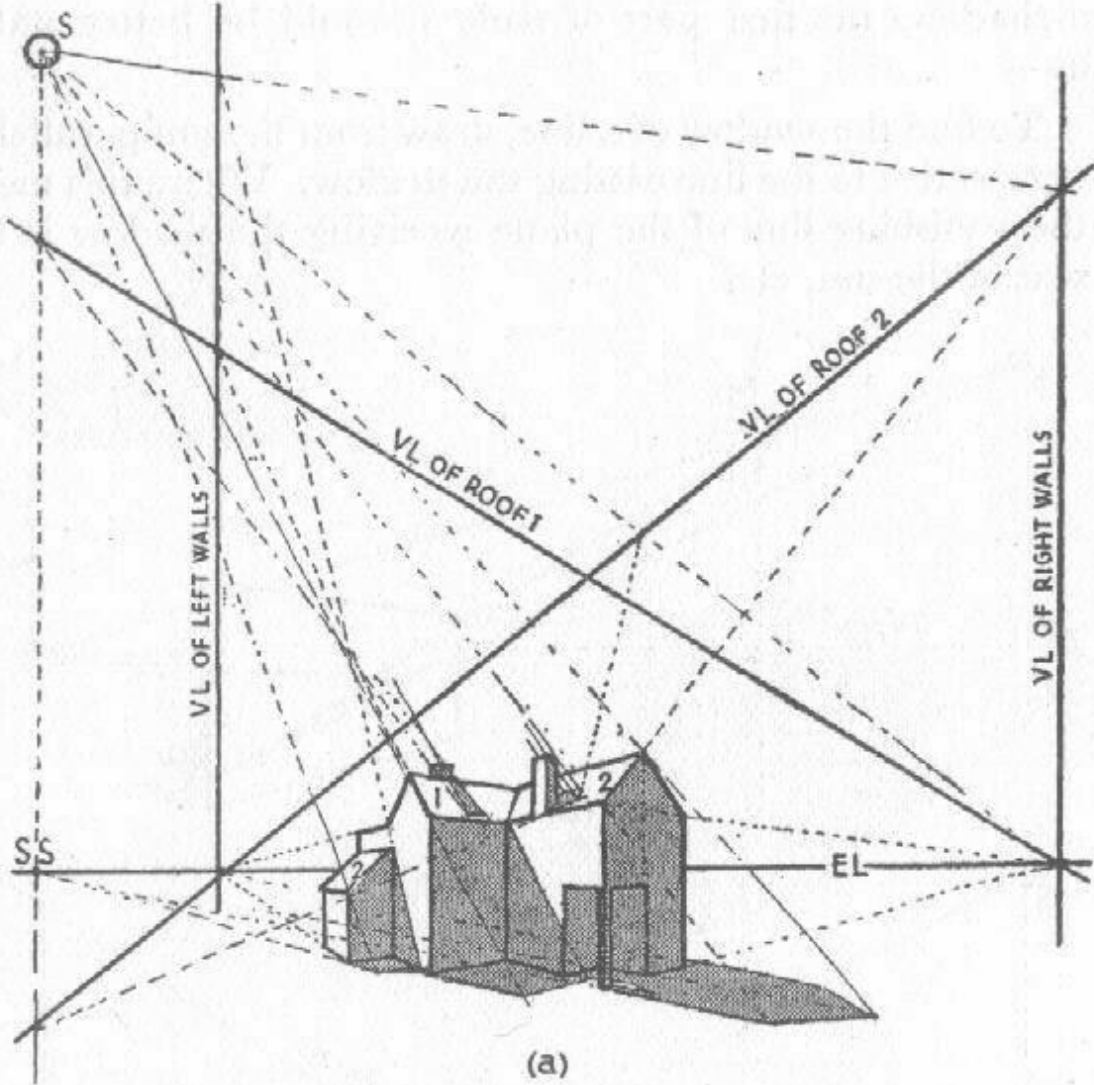

(a)

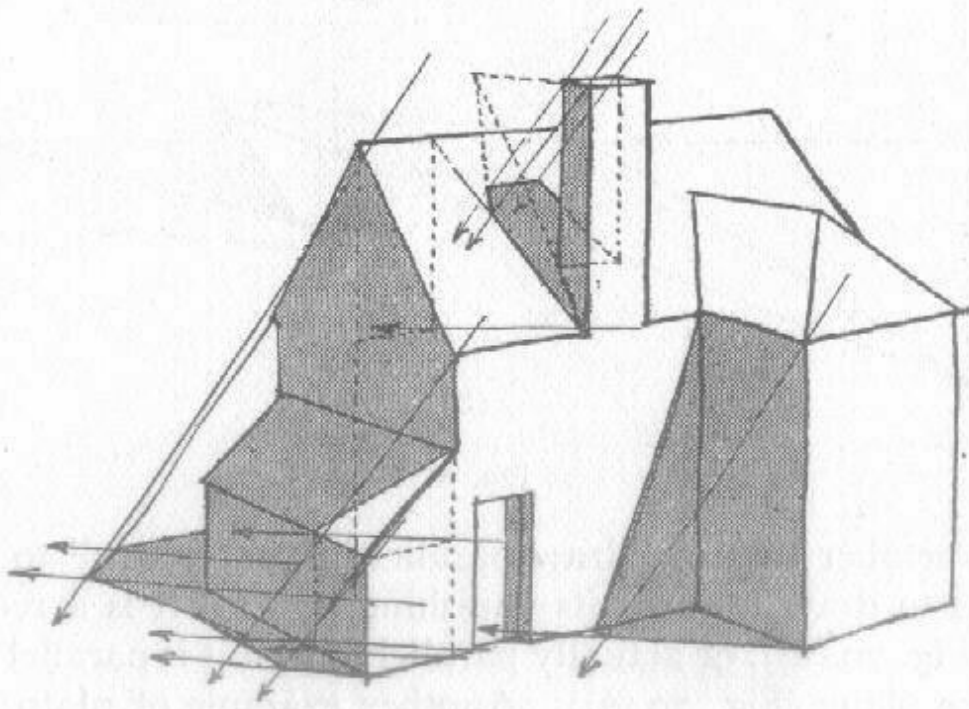

(b)

FIG. 71

INDICACION DE LA HORA POR MEDIO DE SOMBRAS

SI COMPRENDEIS LOS PRINCIPIOS DADOS EN LAS PAGINAS 82 A 87, SEREIS CAPAZ DE PRESTAR UNA LUZ CONVINCENTE A TODOS LOS TEMAS, AUN LOS QUE SEÑALAN LA HORA. A SEÑALA LA LUZ MATINAL EN EL ESTE, B CERCANA A MEDIODIA, CON EL SOL CASI EN EL CENIT, C AL PROMEDIAR LA TARDE Y D POCO ANTES DE LA PUESTA DEL SOL.

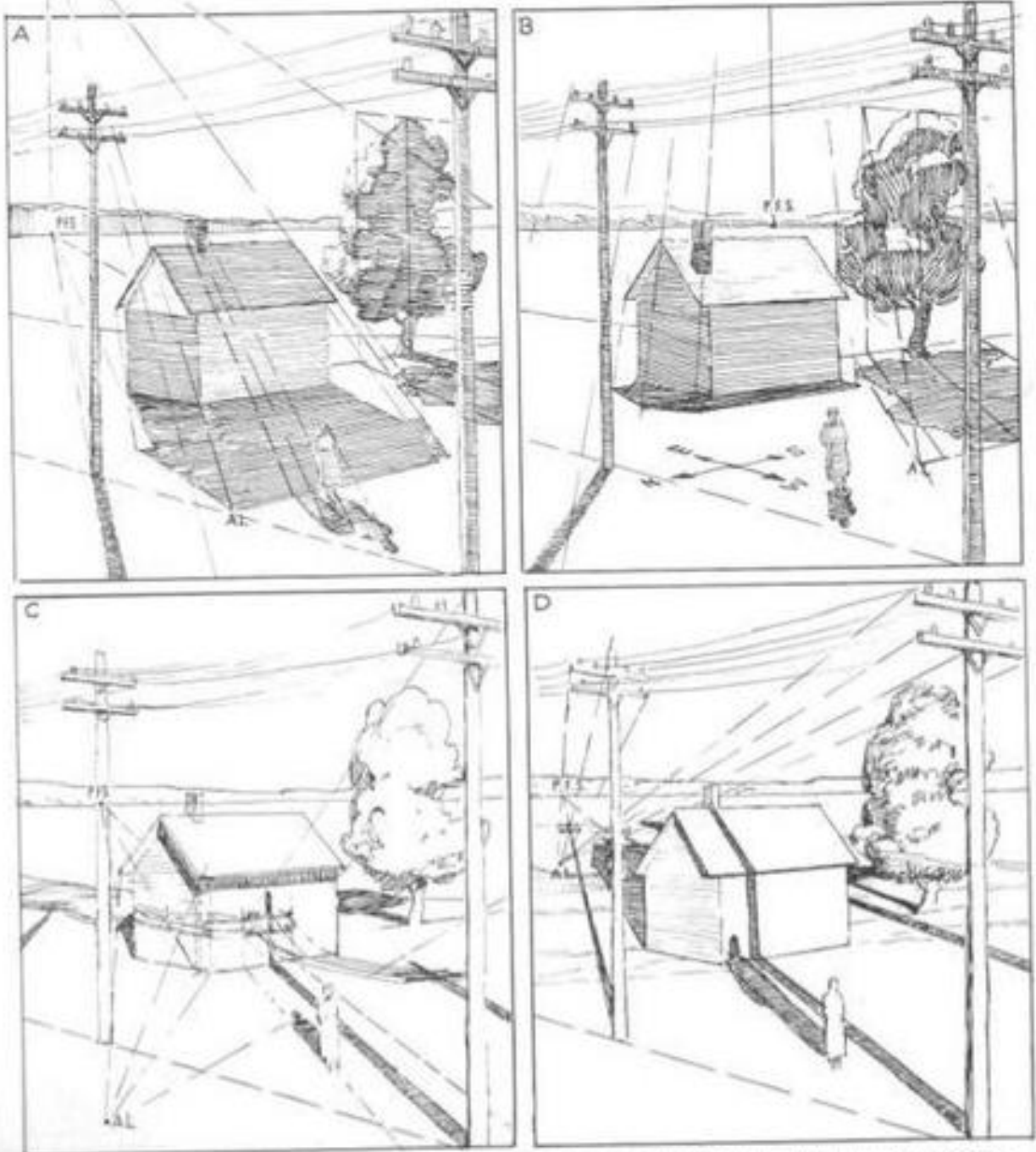

PARA ILUSTRARLO SE ELIGIO UN TEMA MUY SENCILLO. SE SUPONE UN PLANO DE TIERRA LLANO. LAS SOMBRAS SUFREN EL EFECTO DE LAS ONDULACIONES DEL PLANO DE SUPERFICIE.

## ÖRNEK MEKÂN ÇİZİMLERİ

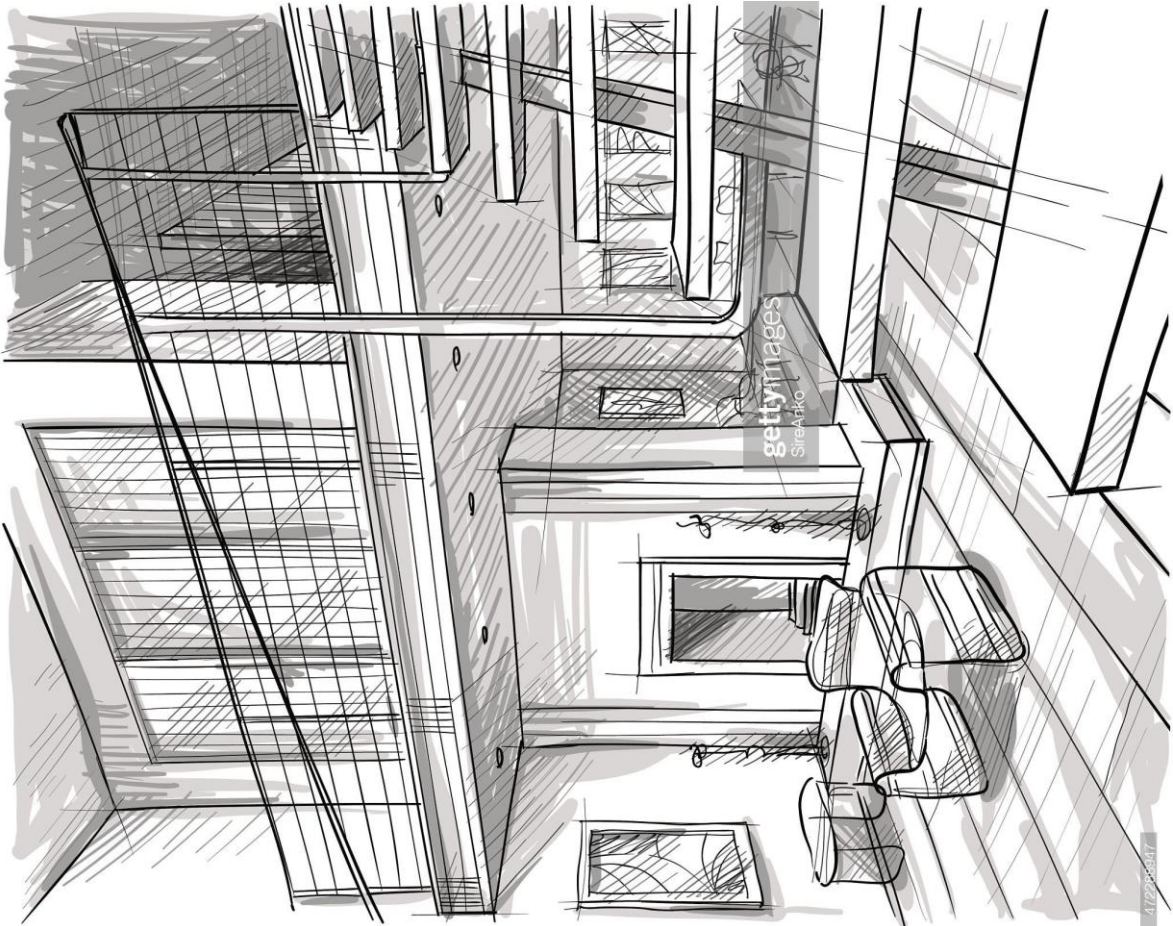
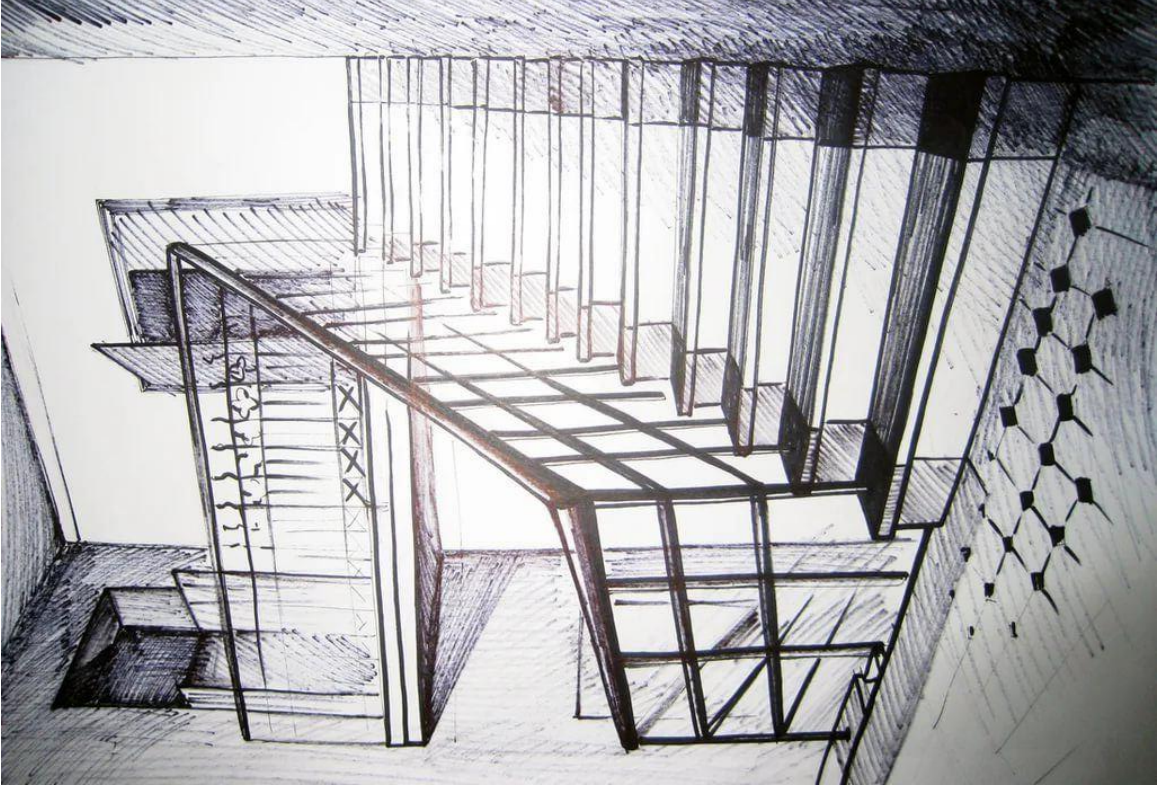

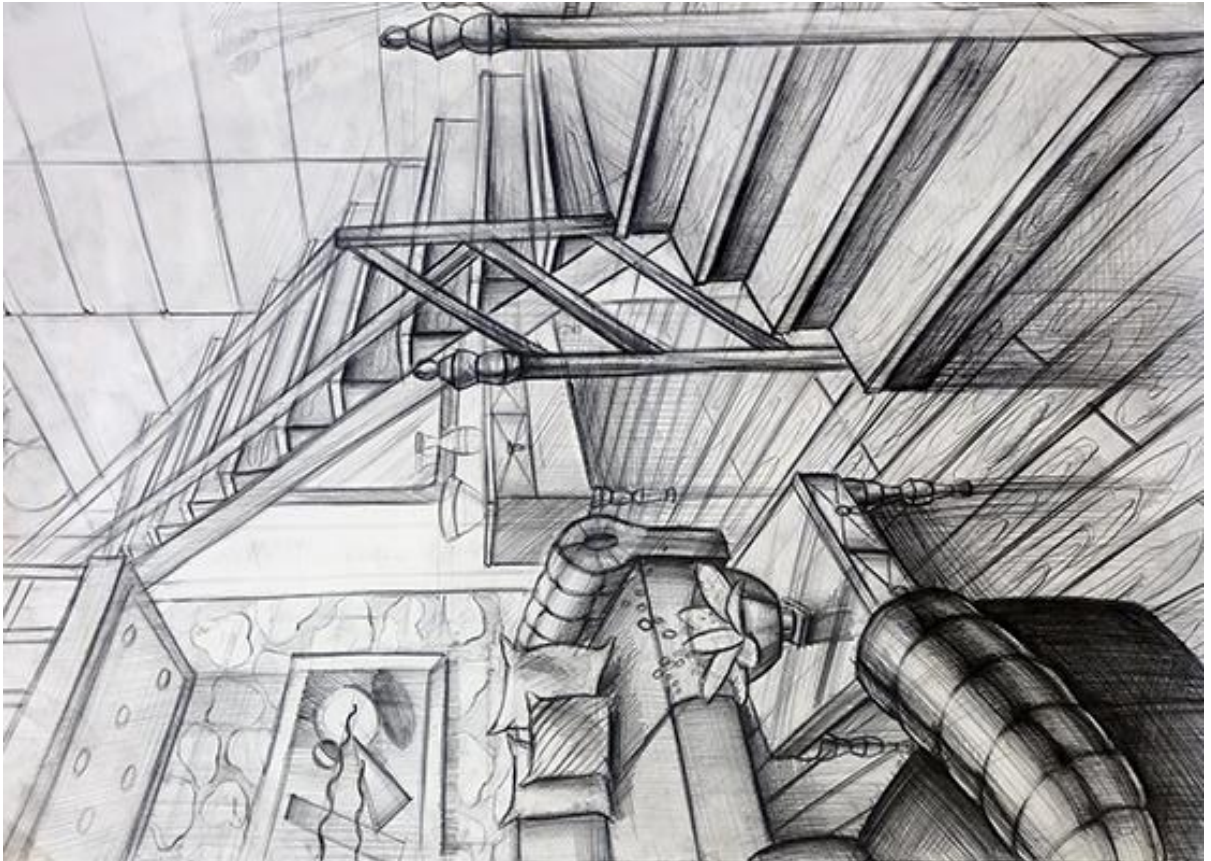
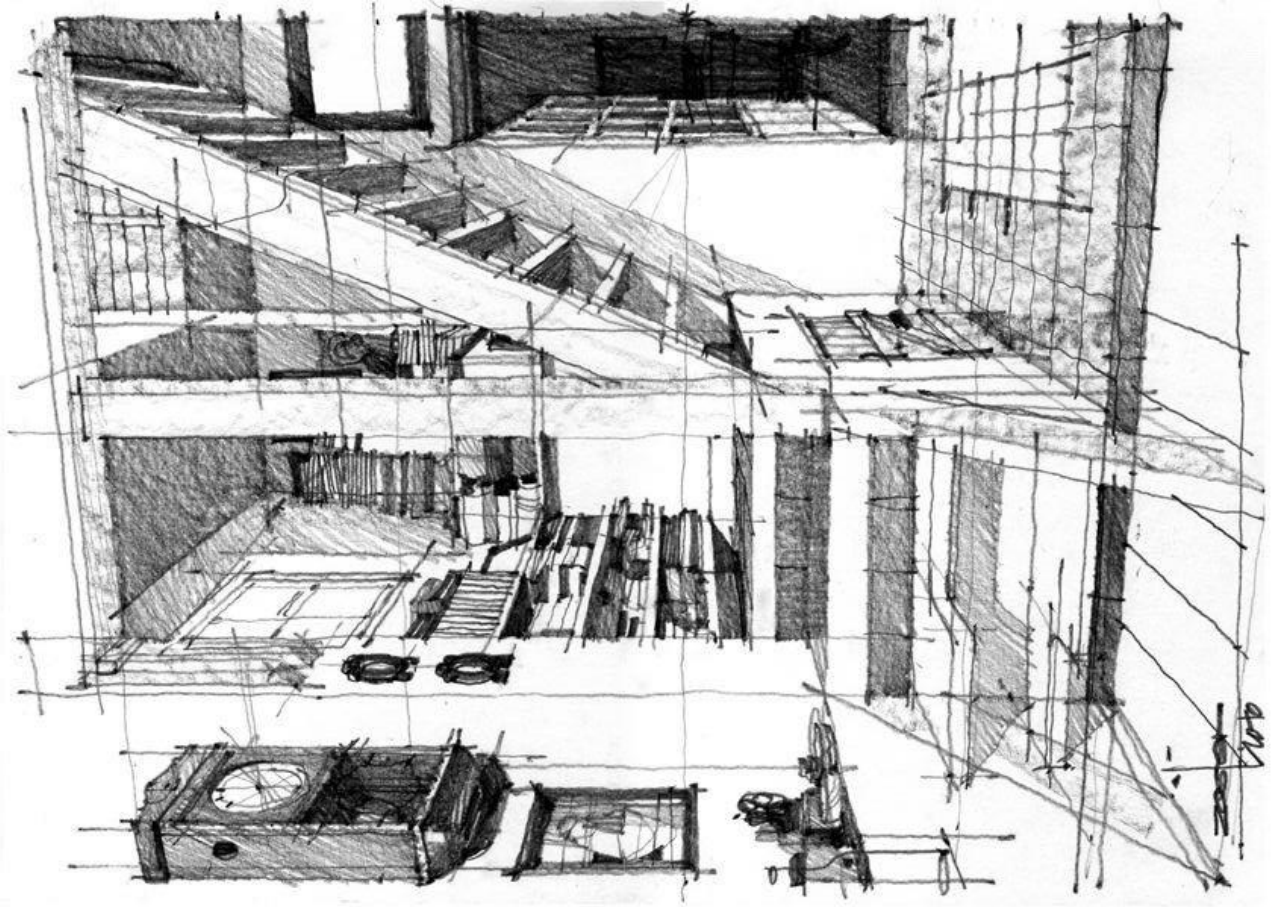



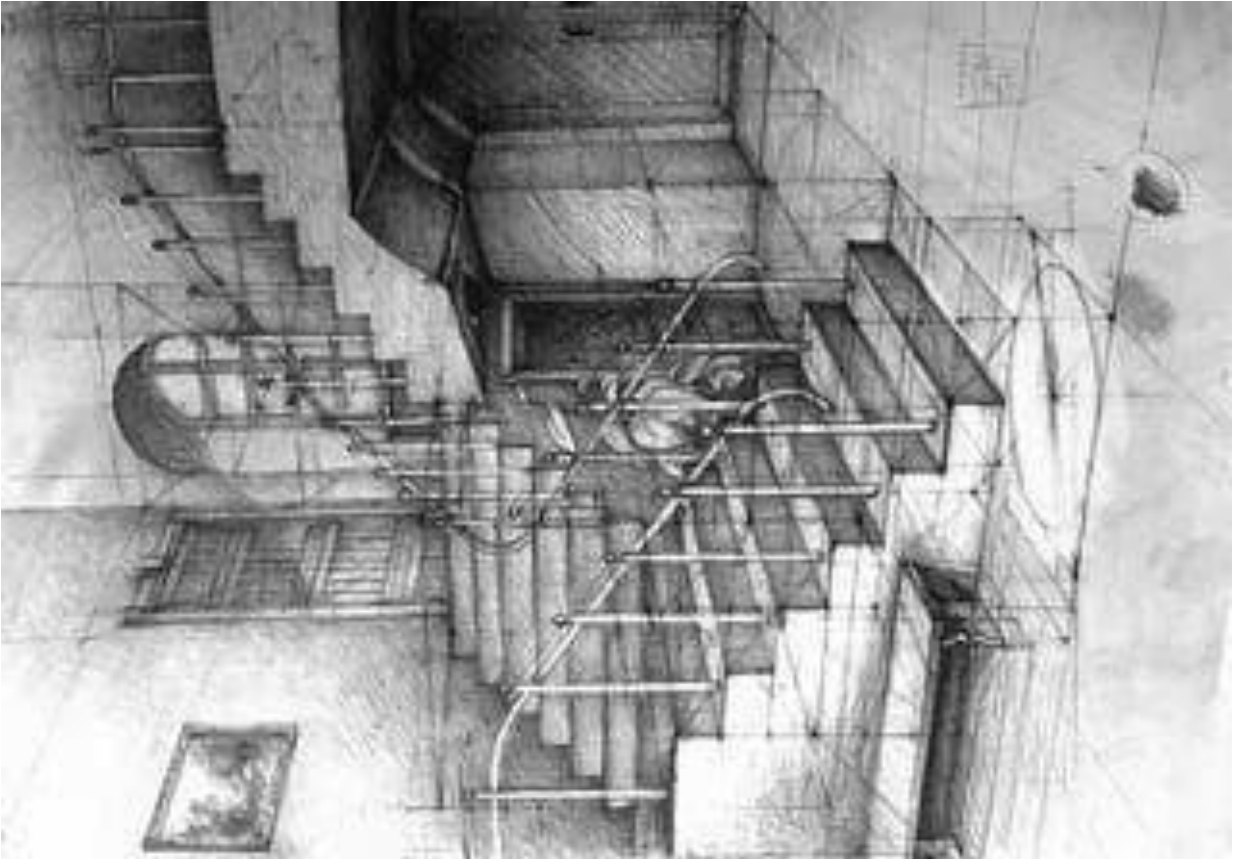
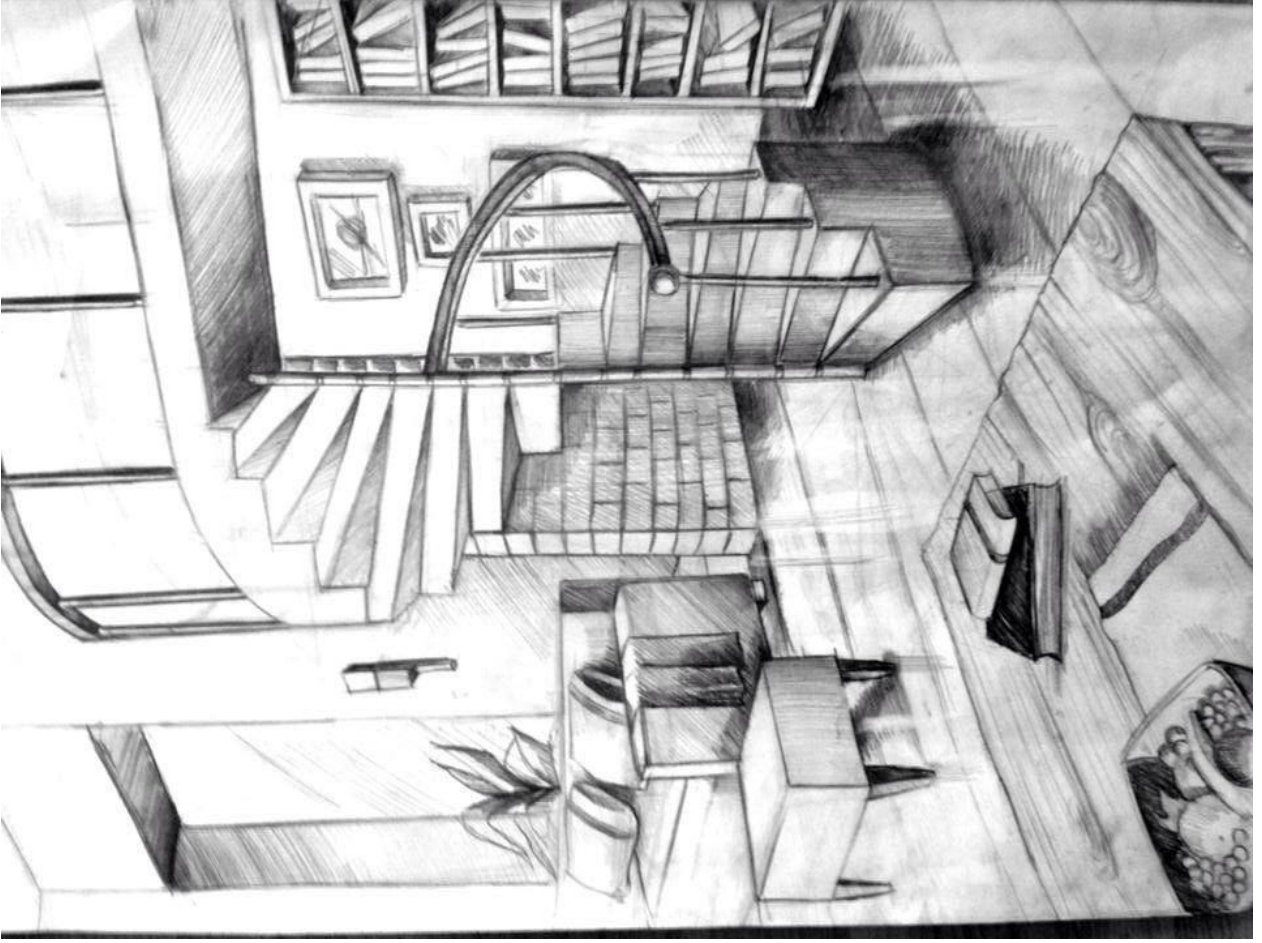

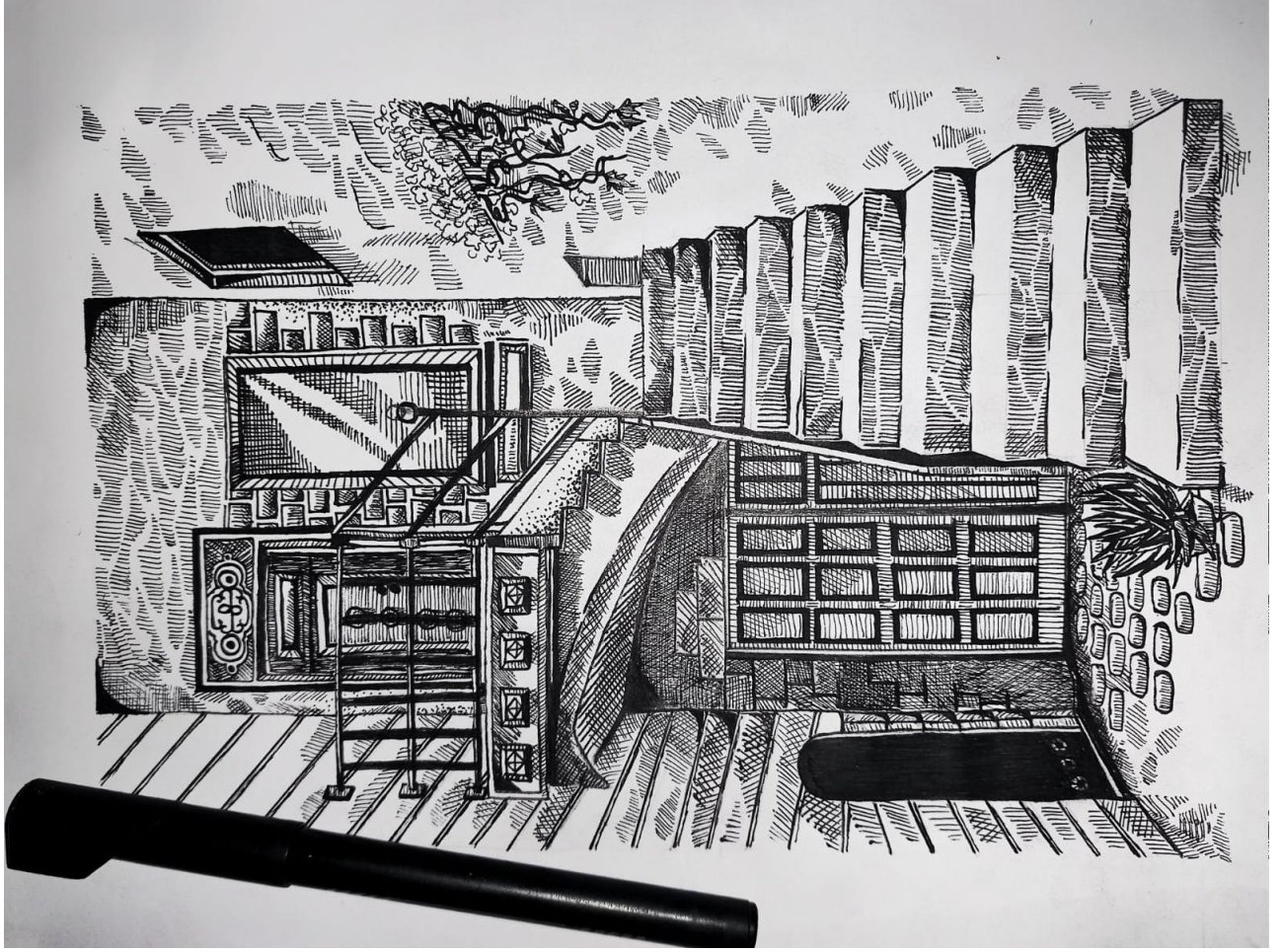







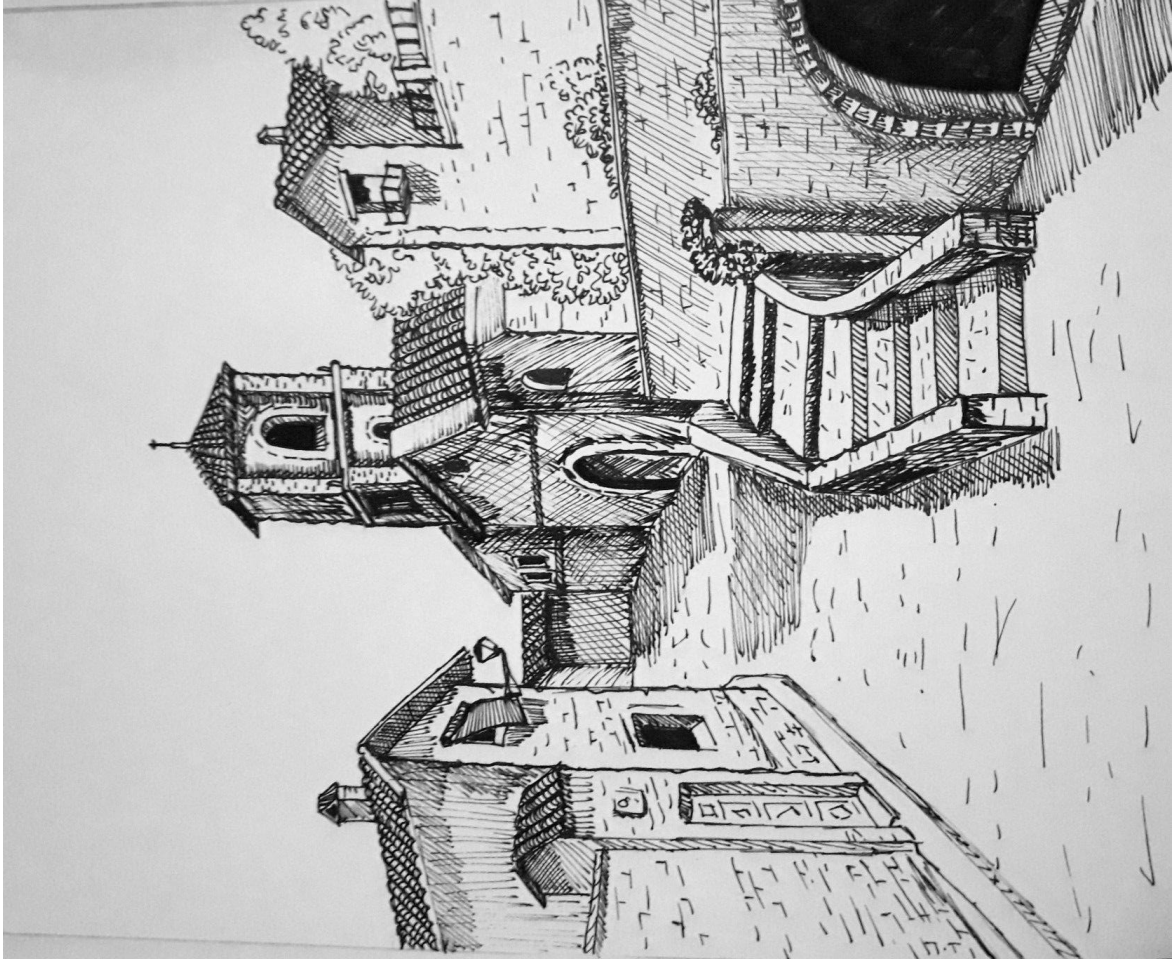

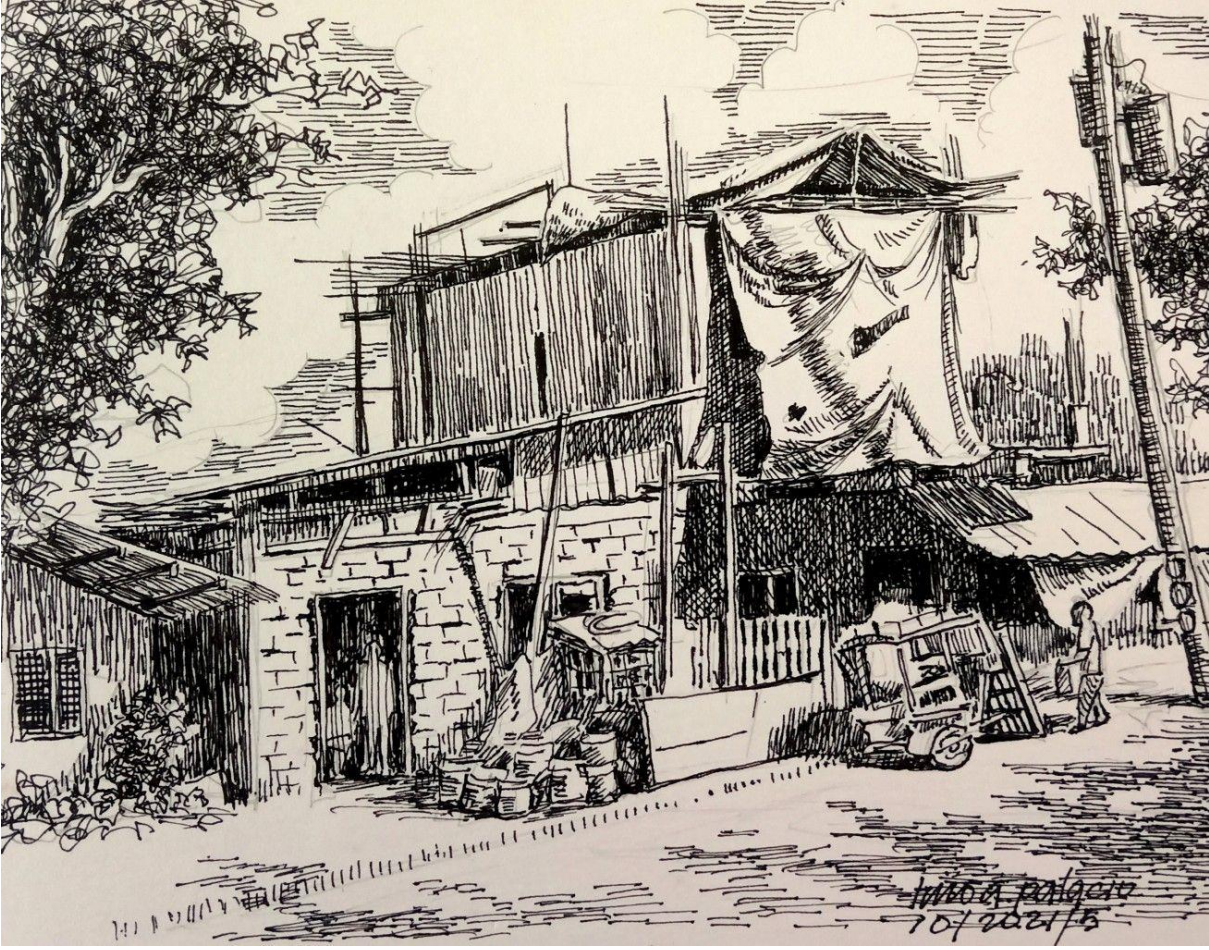

## İMGESEL ALIŞTIRMALARI

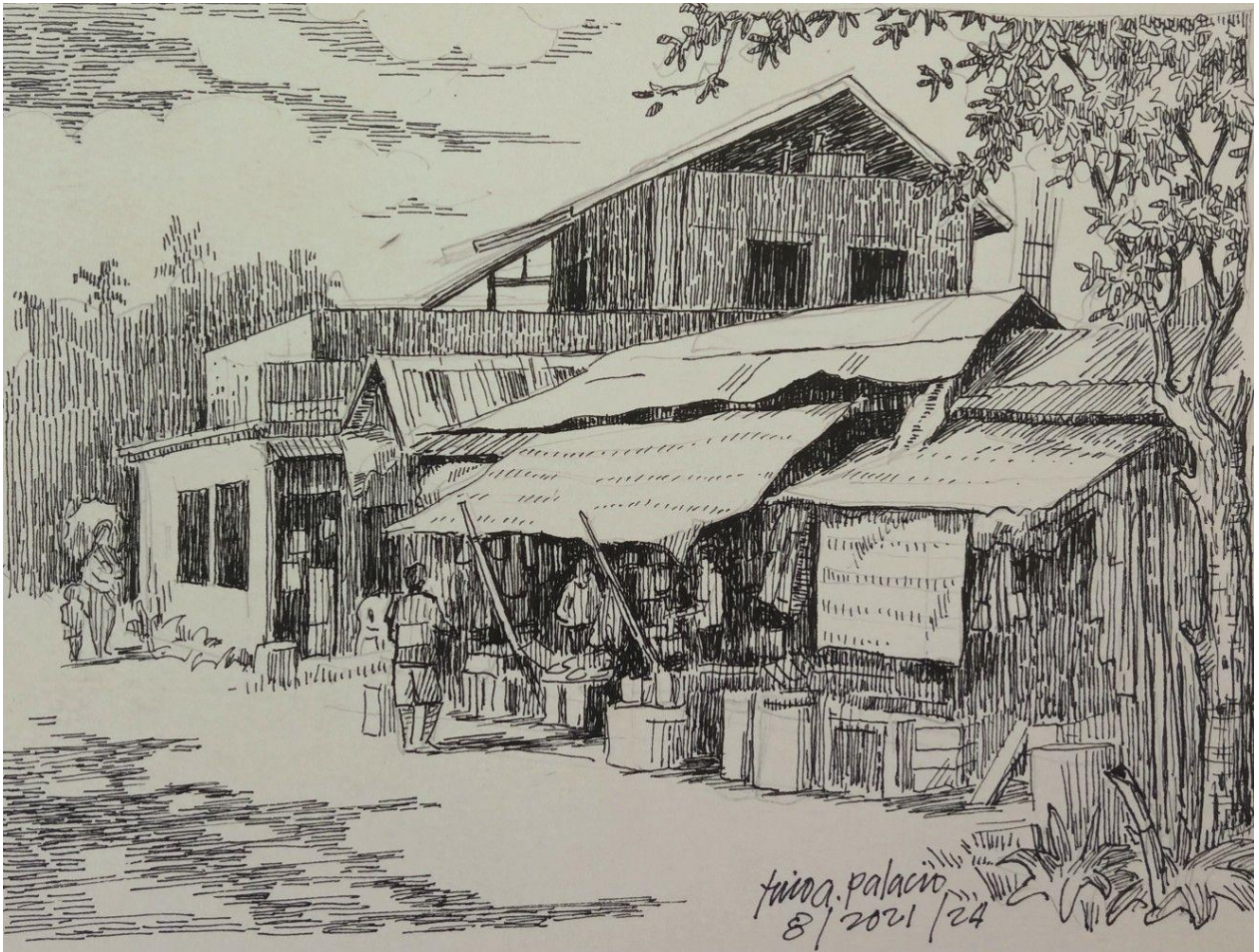





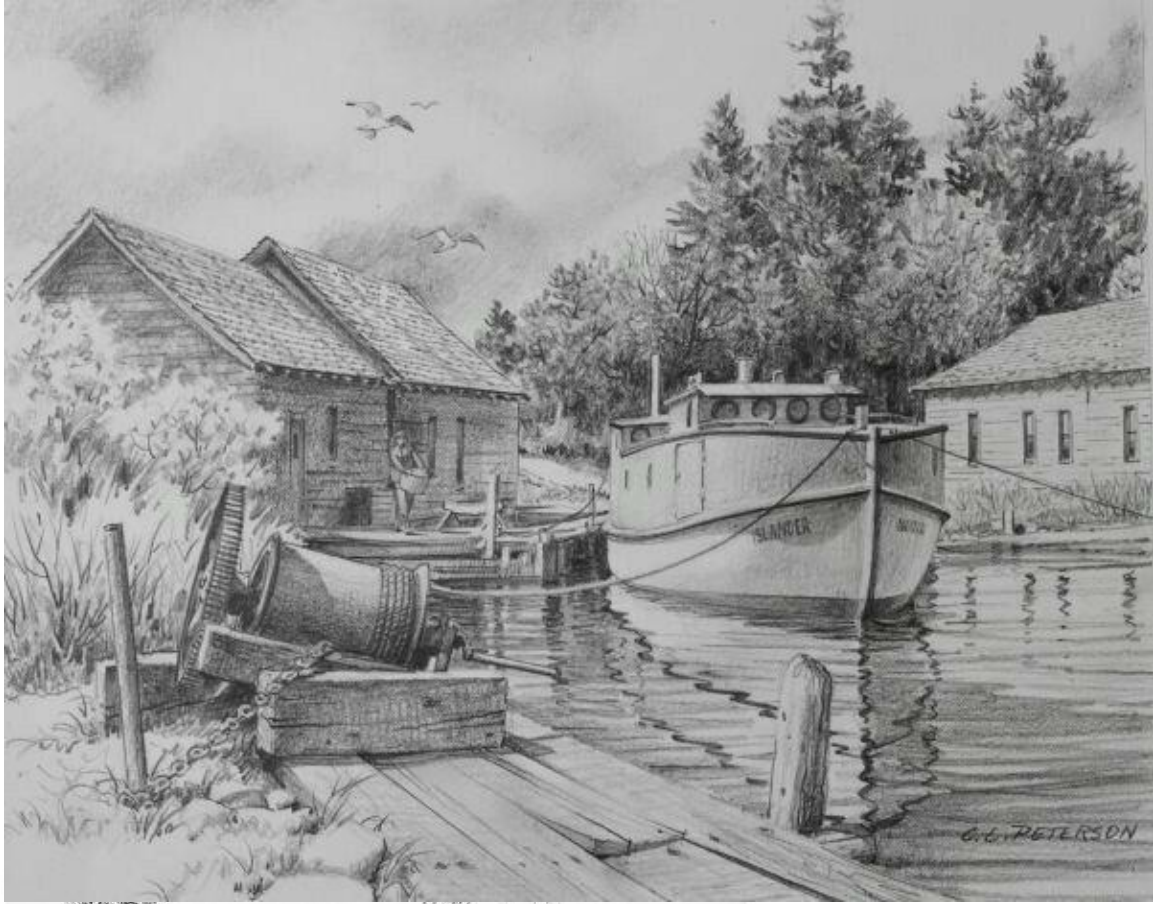

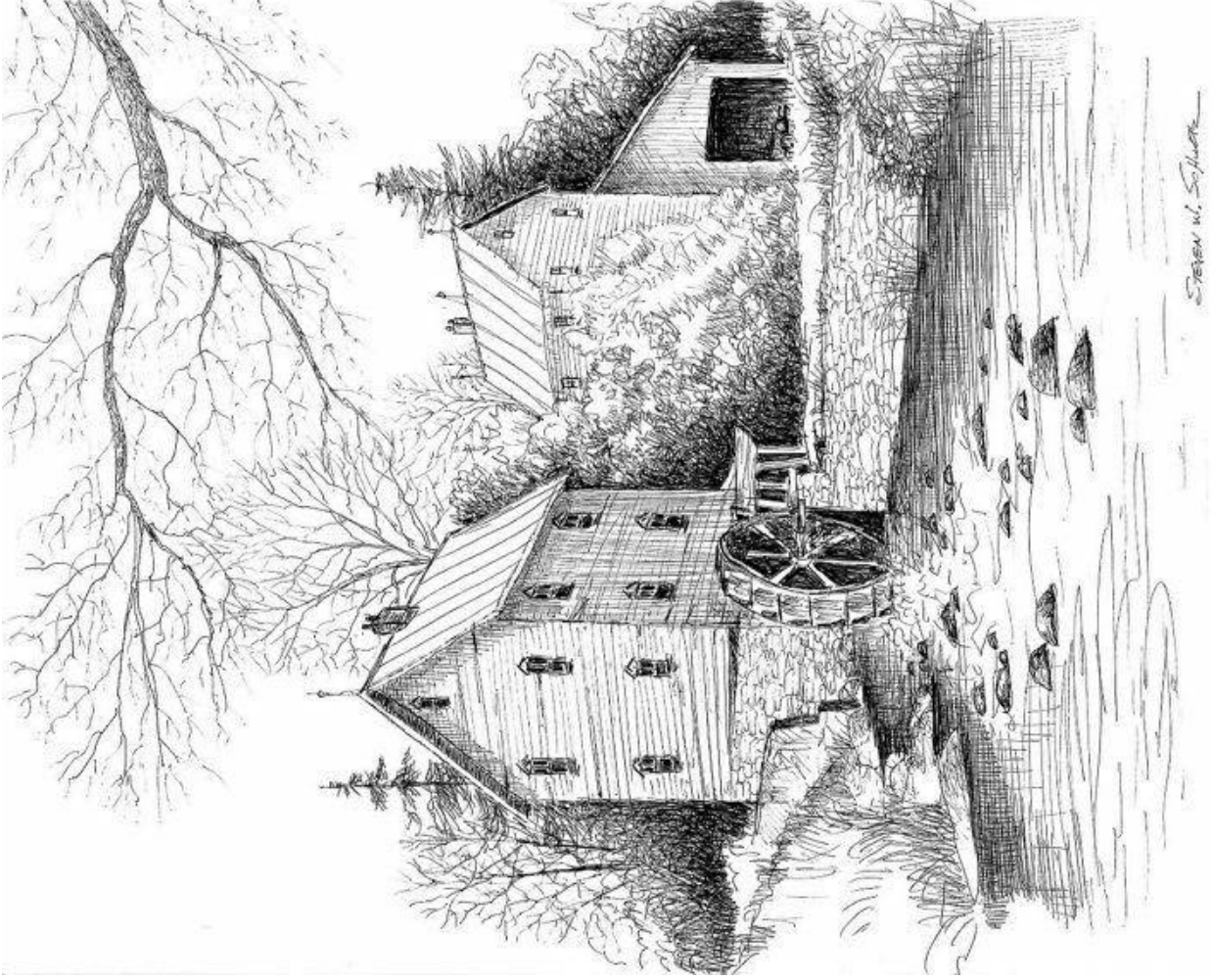

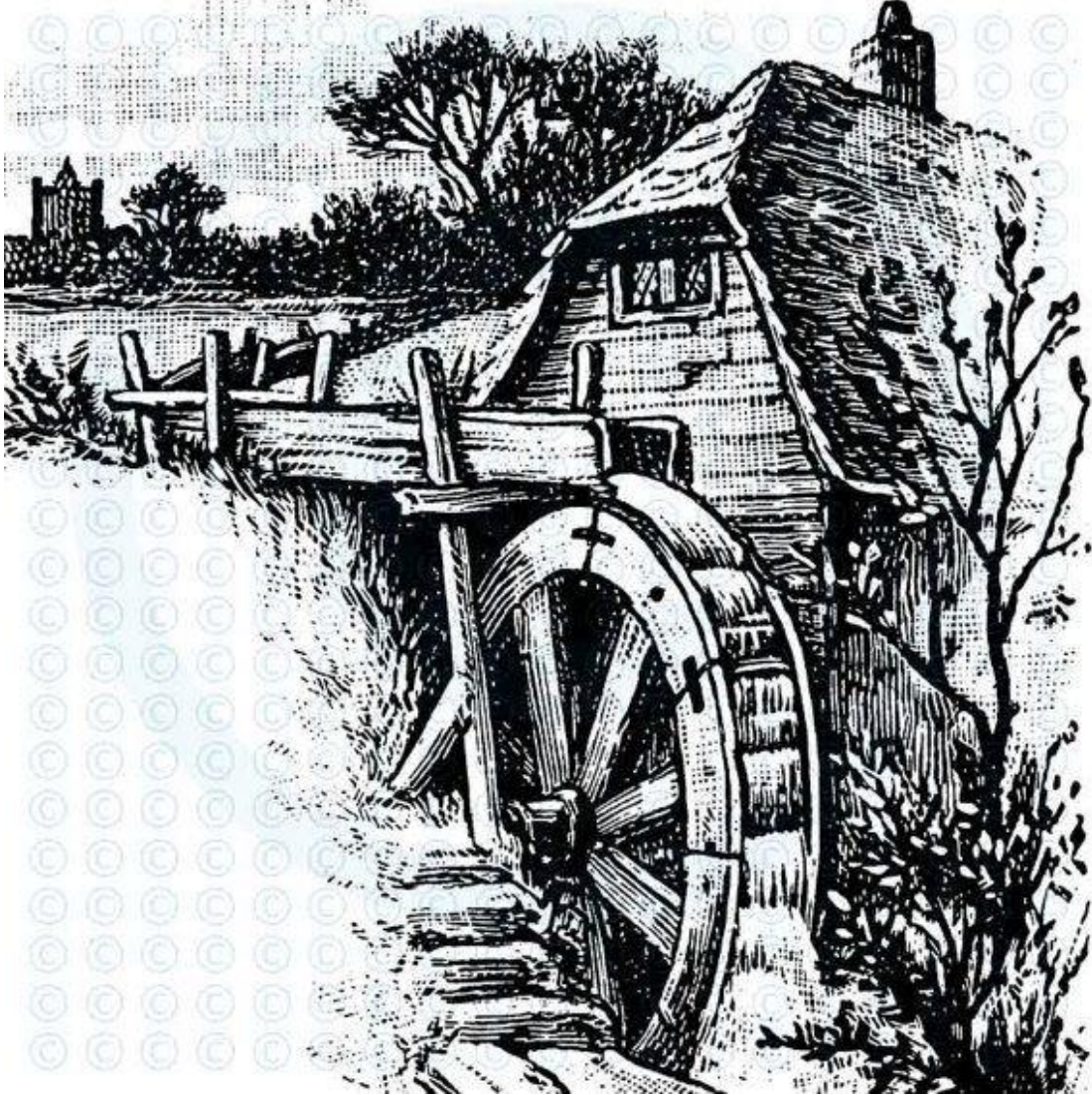
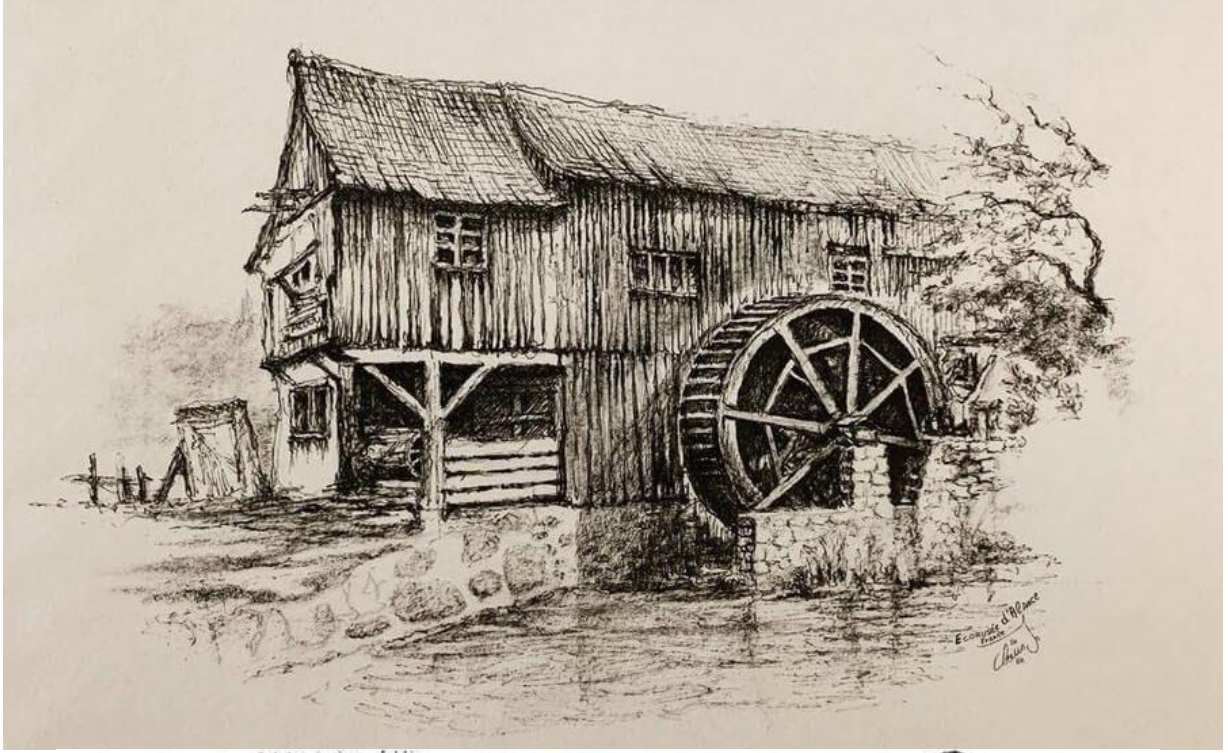

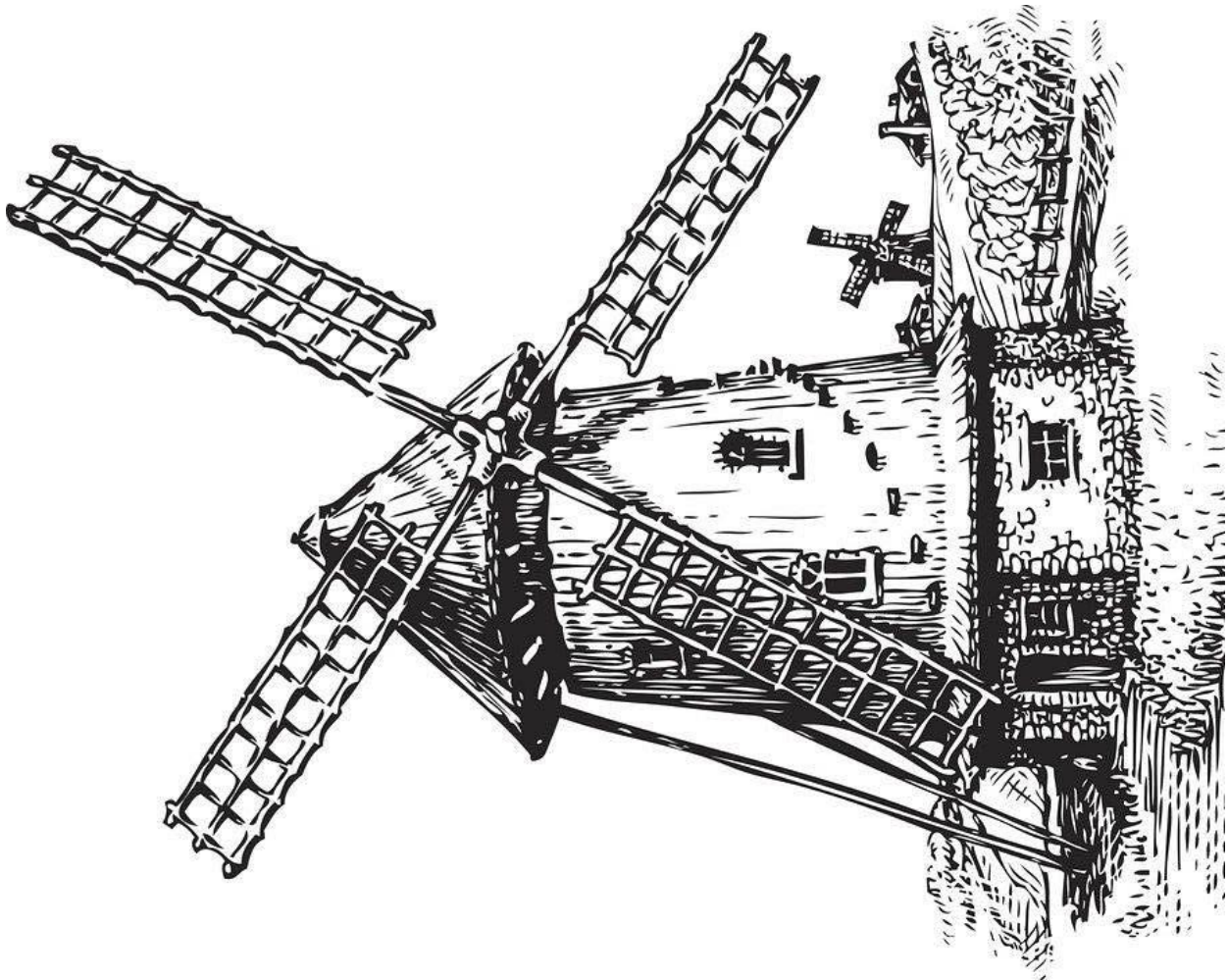
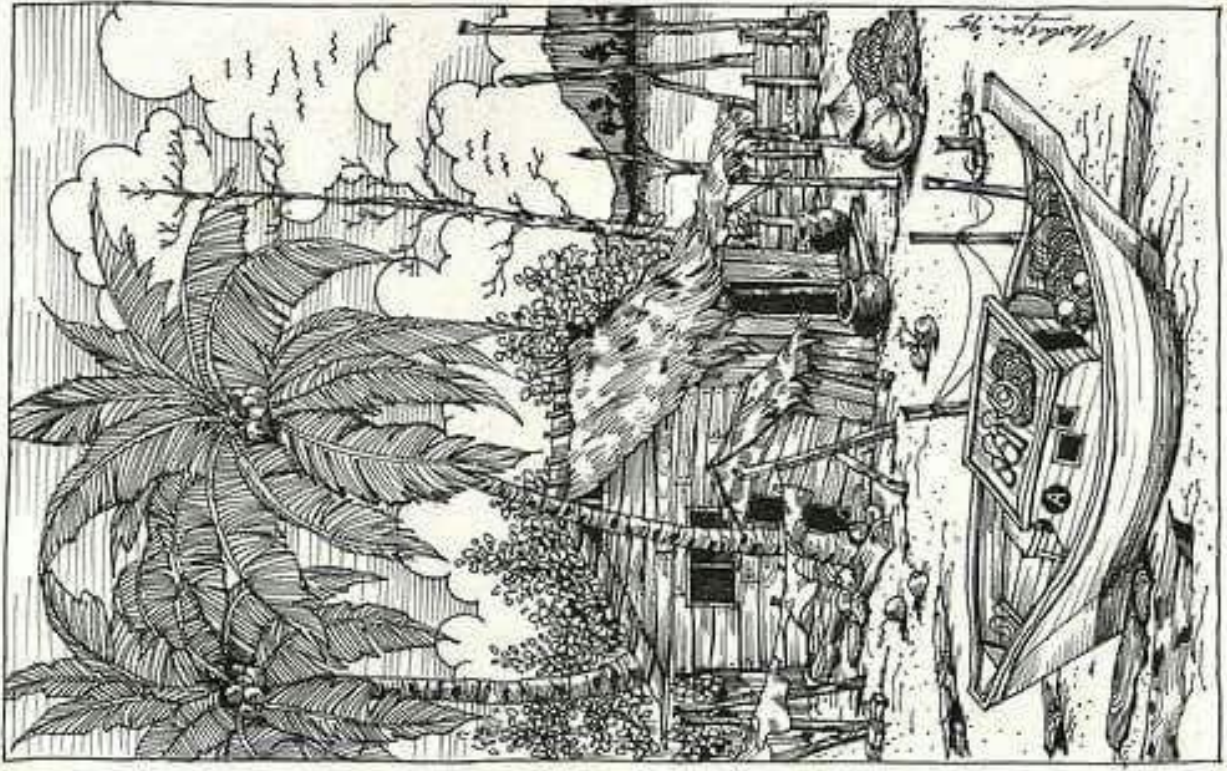



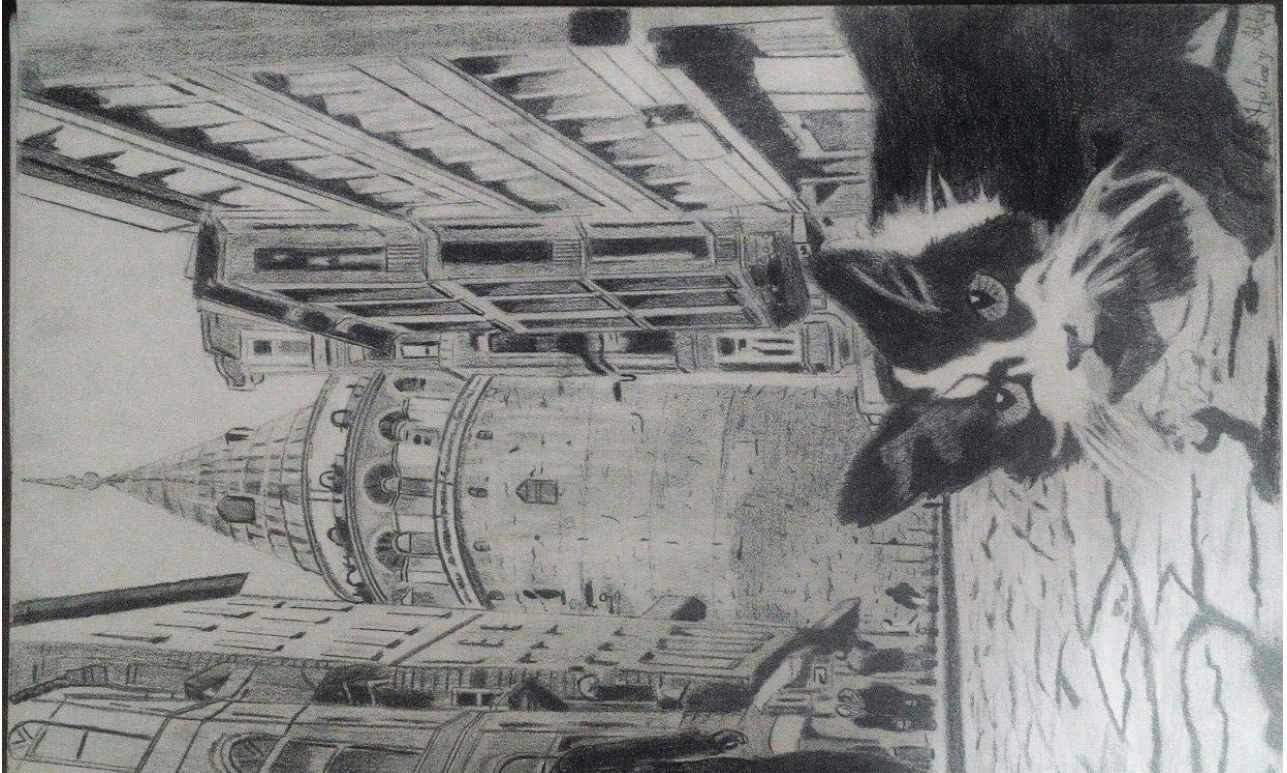
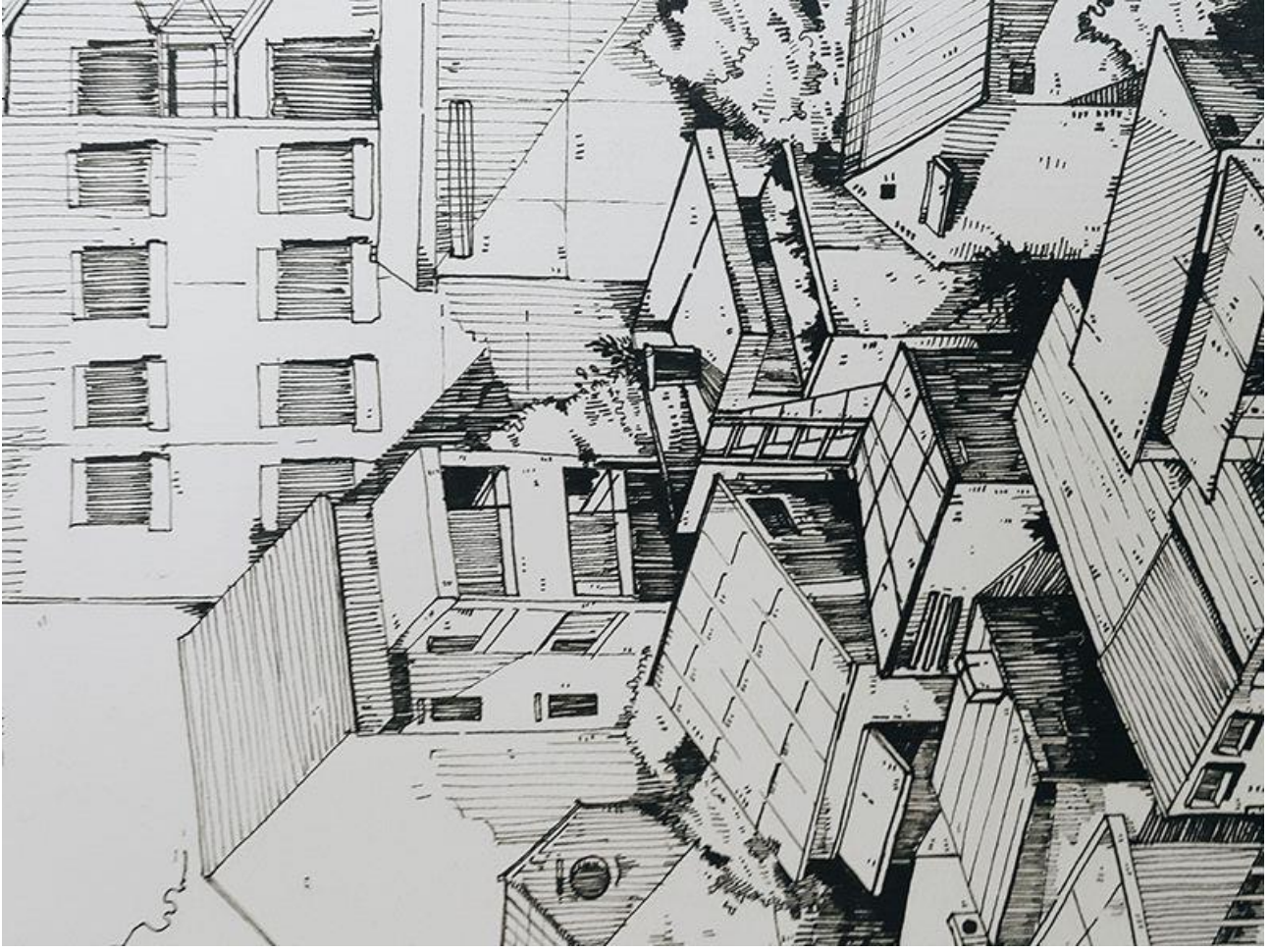

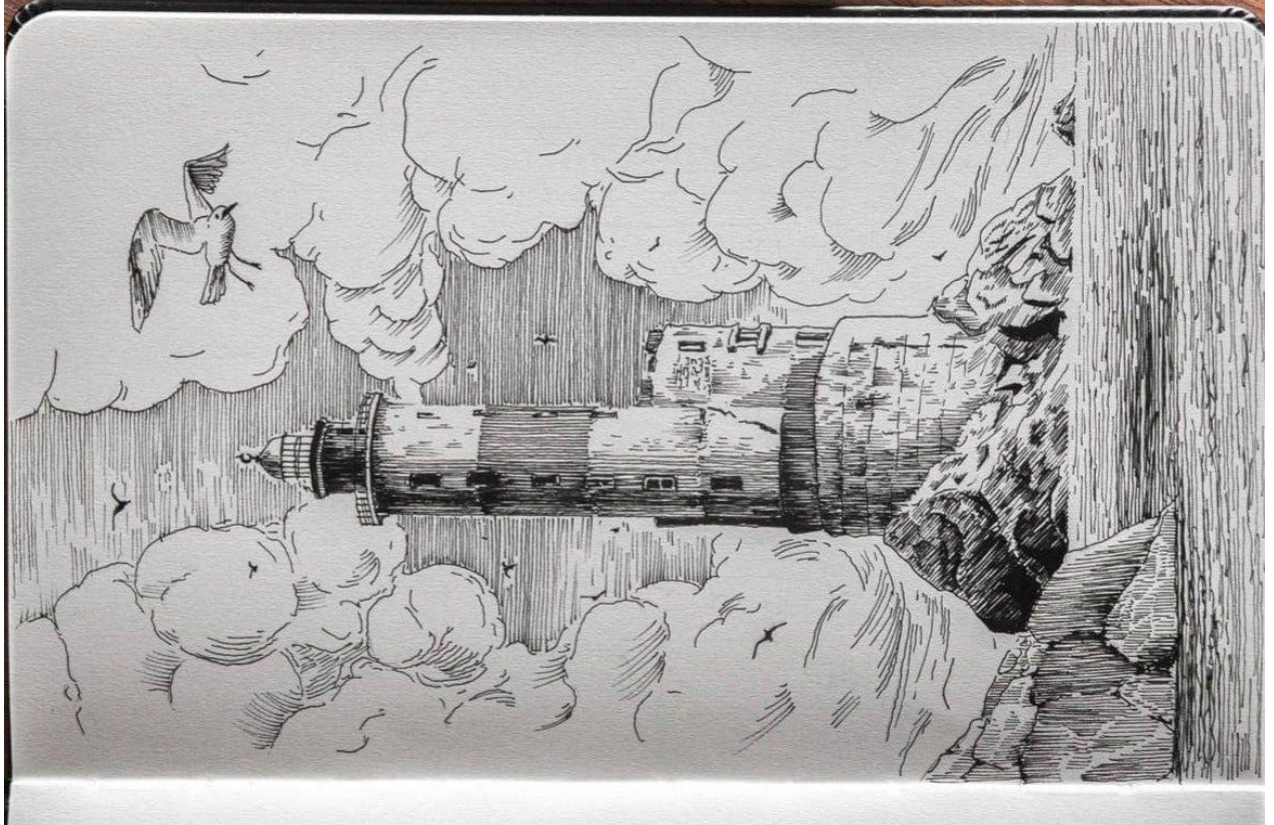
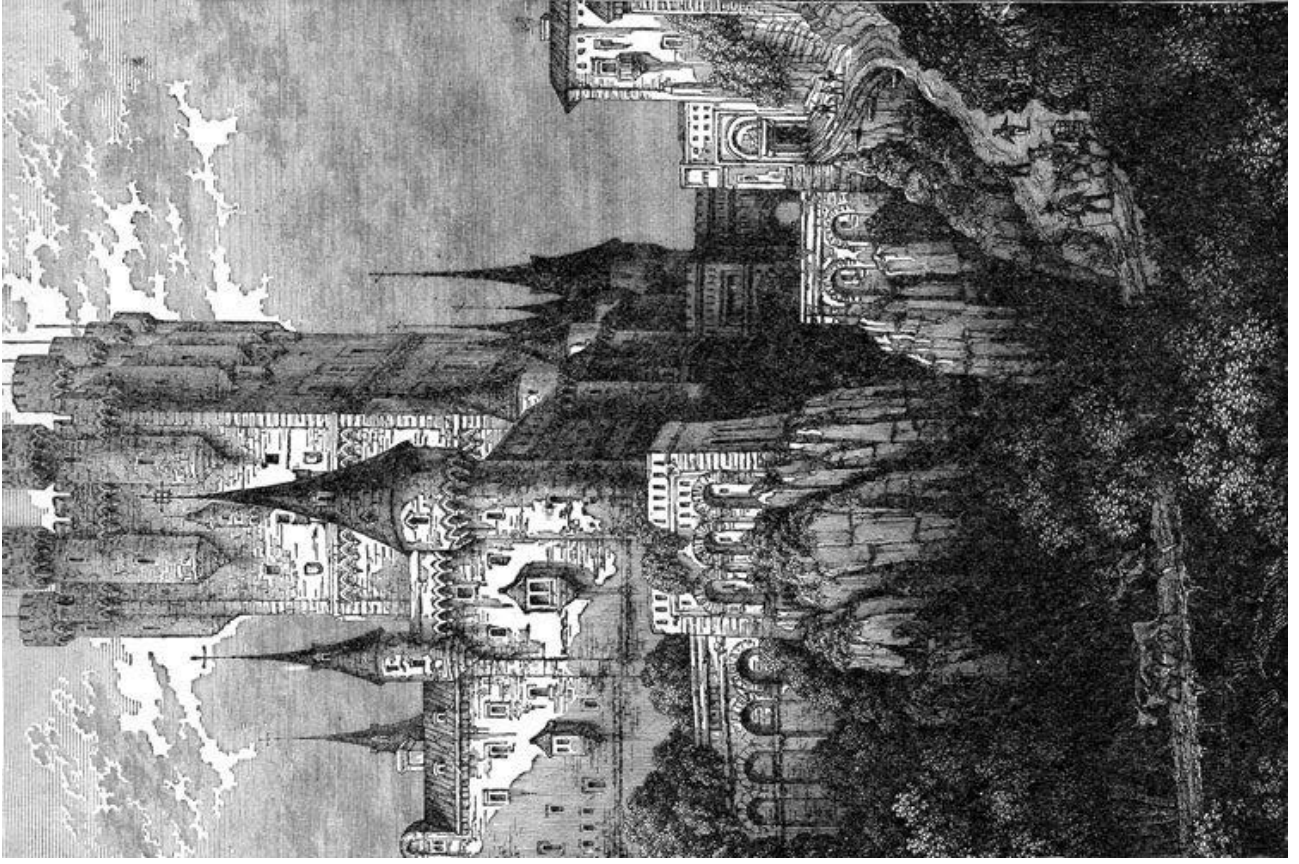



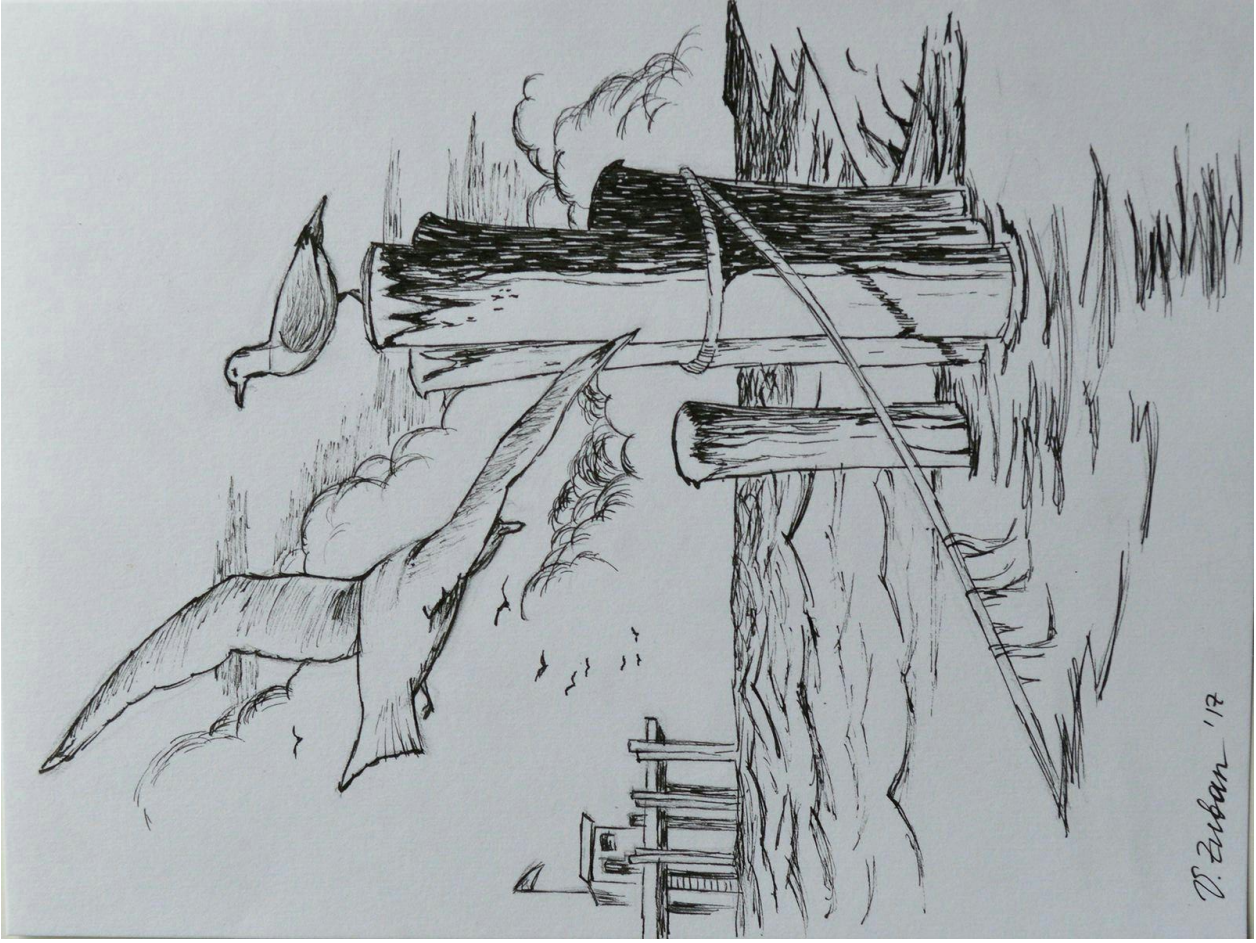

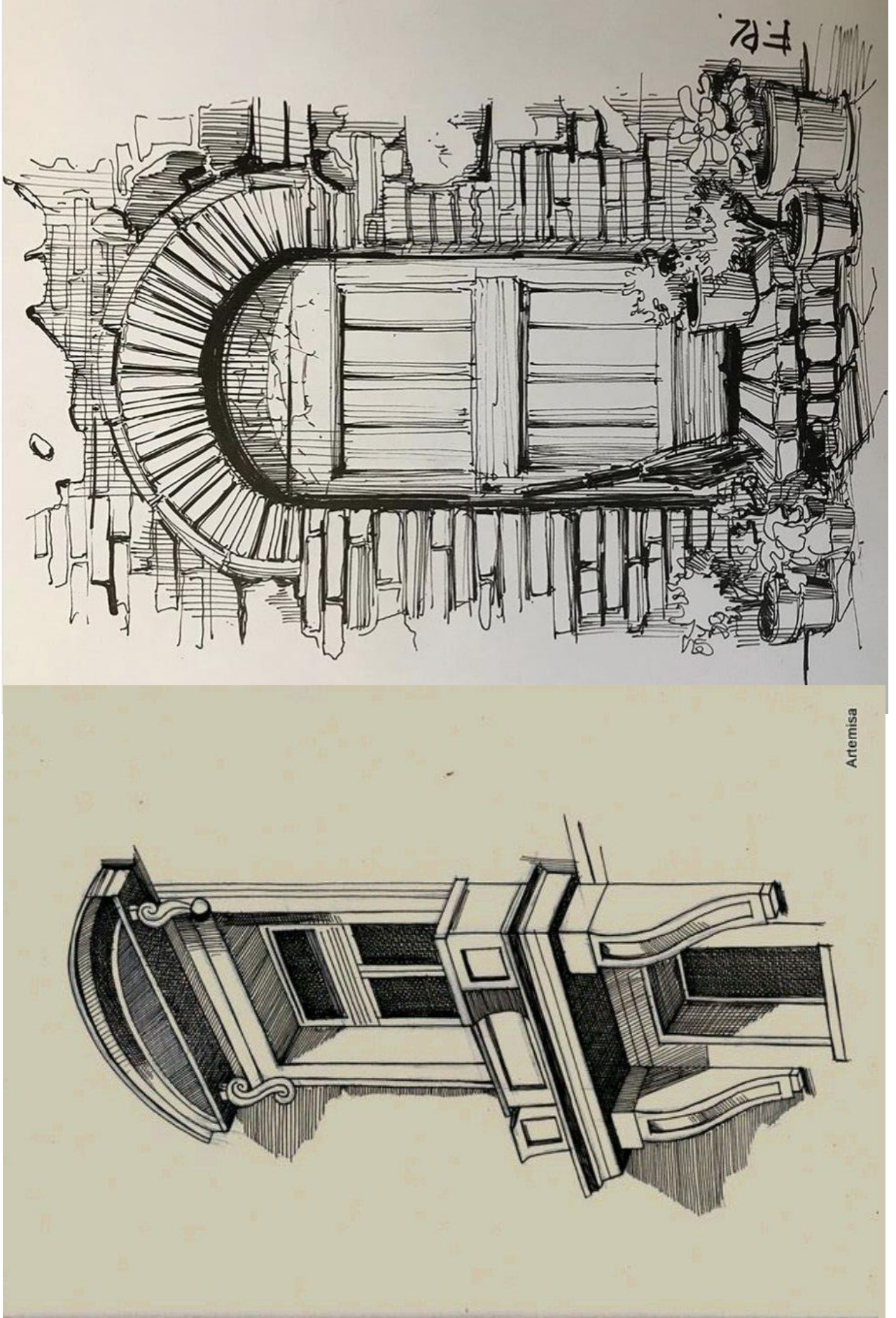

Artemisa

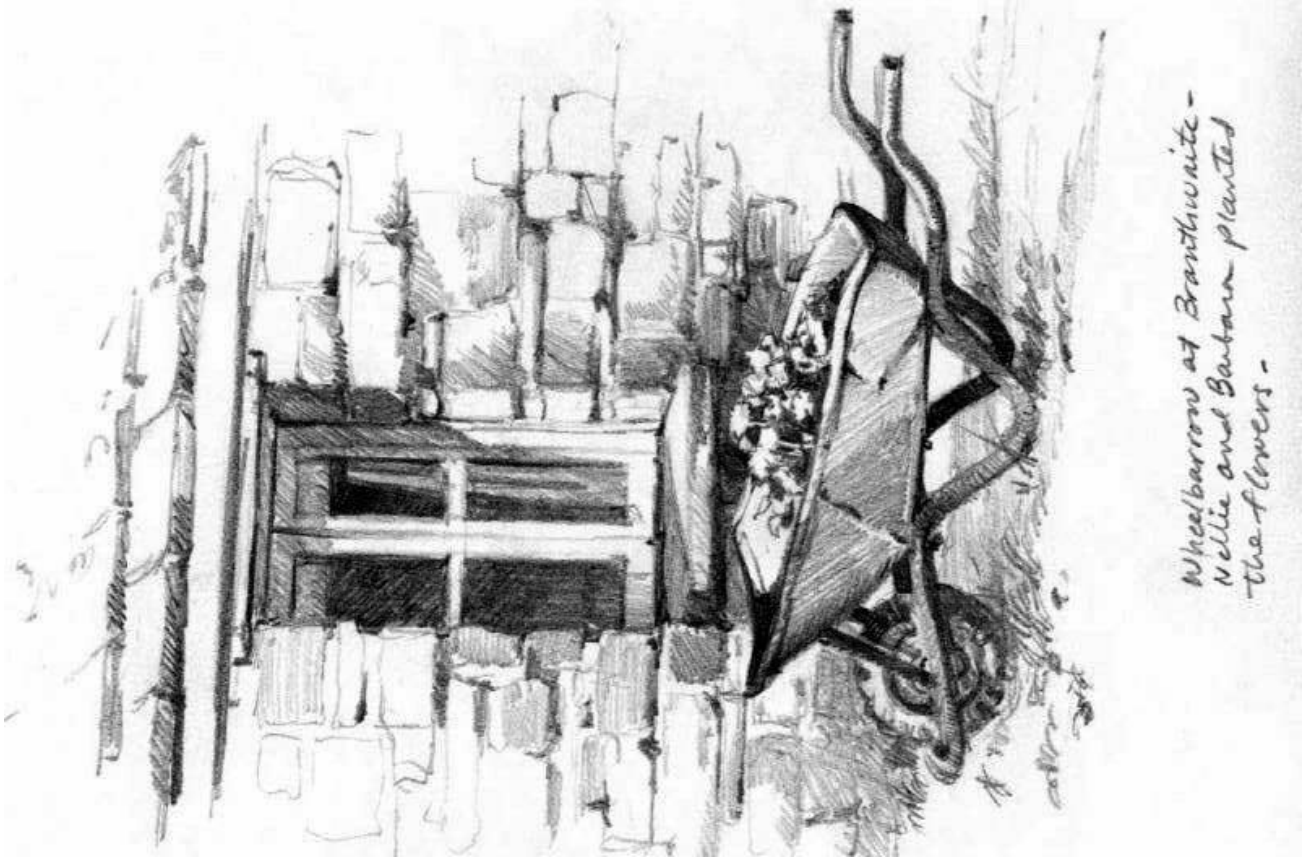

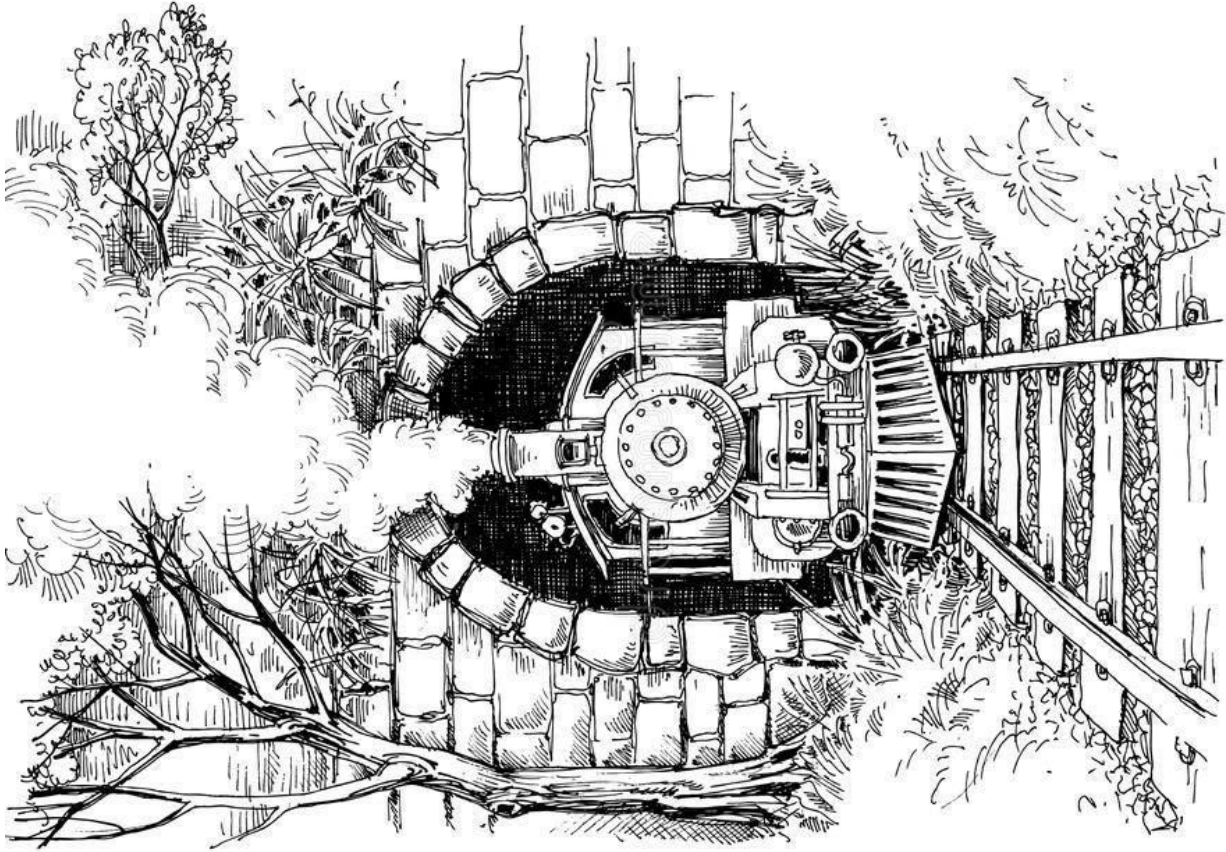
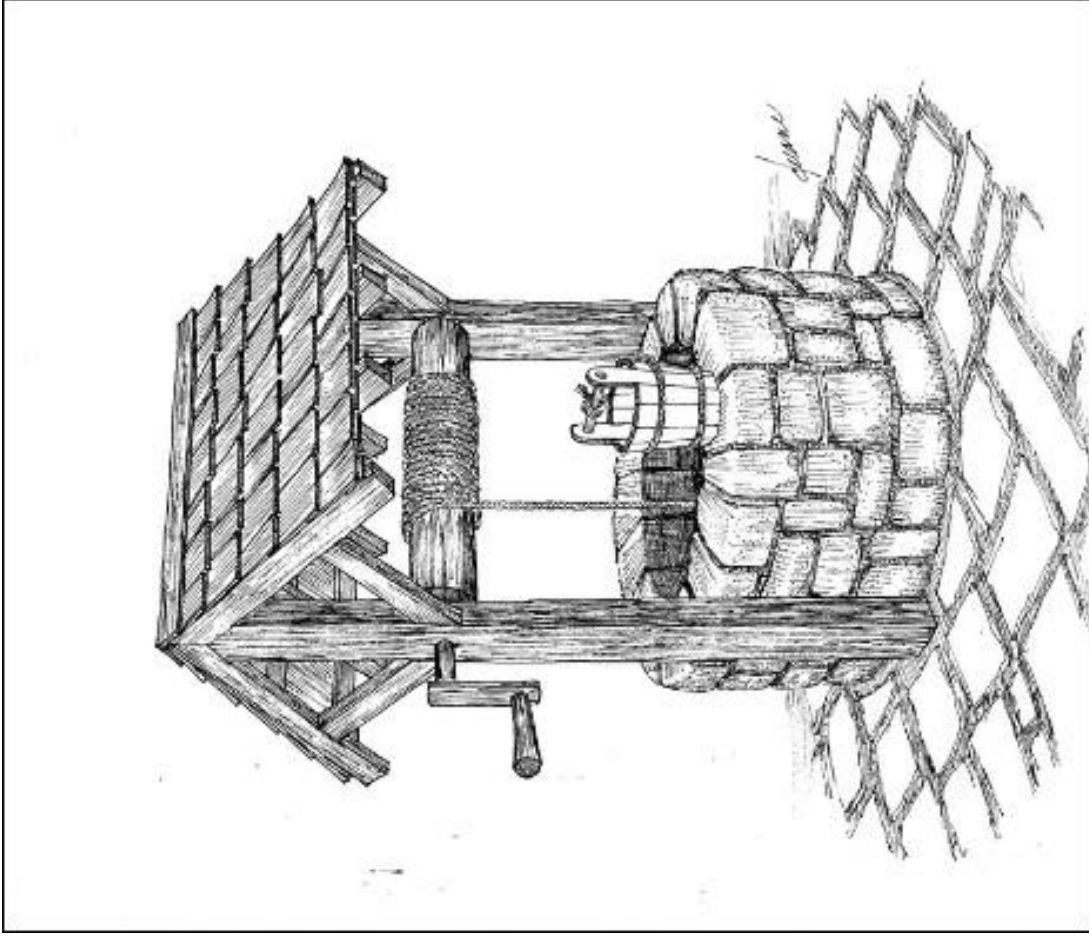



www.shutterstock.com · 537297199

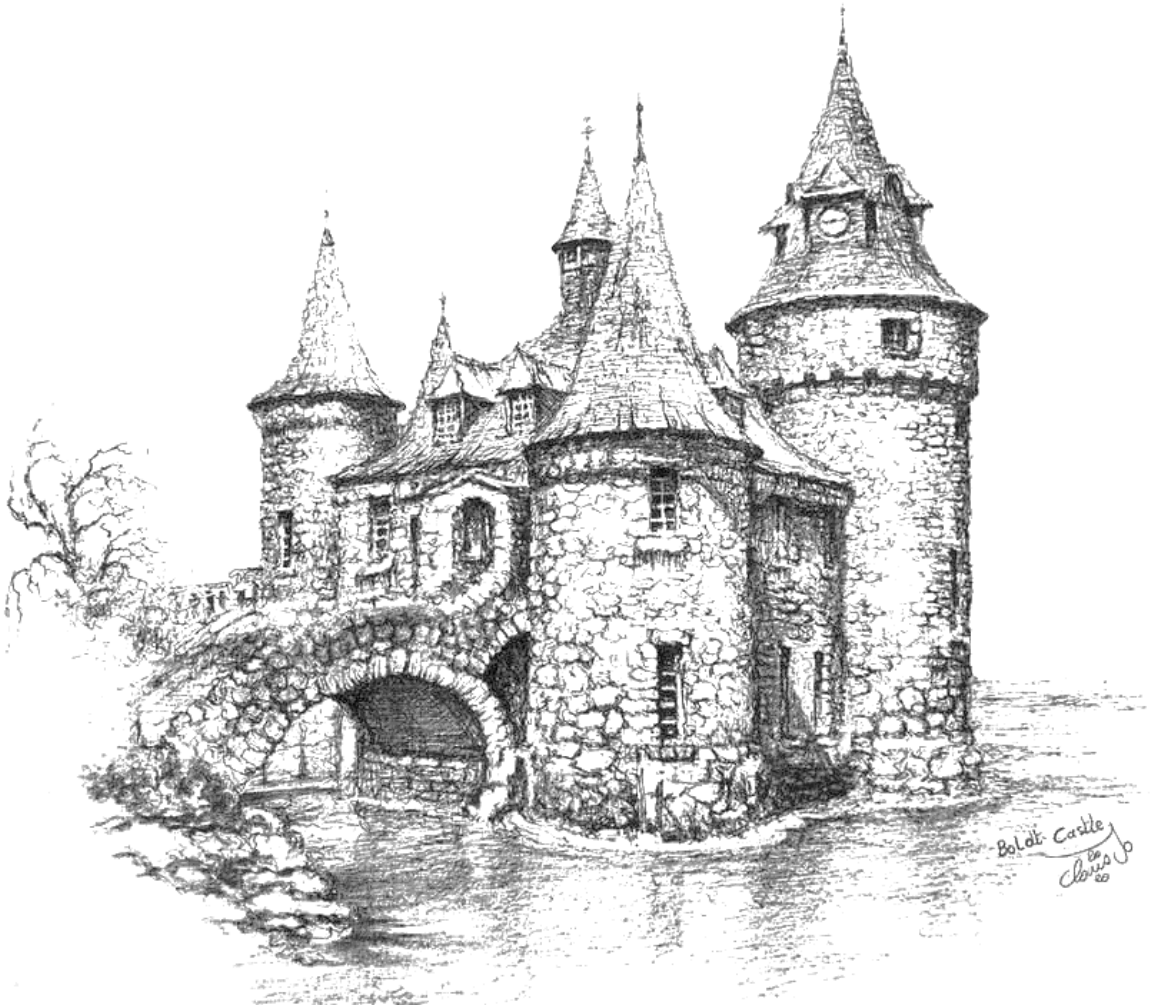

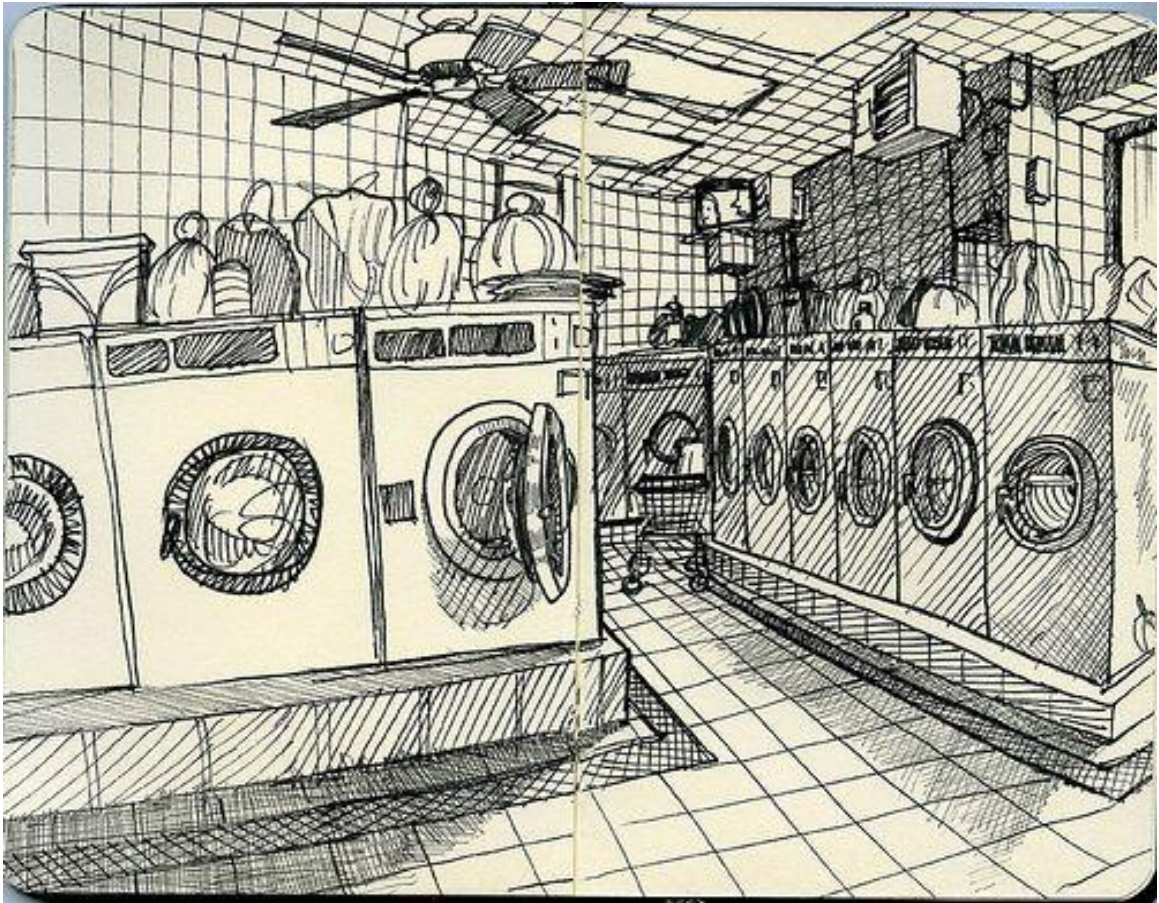

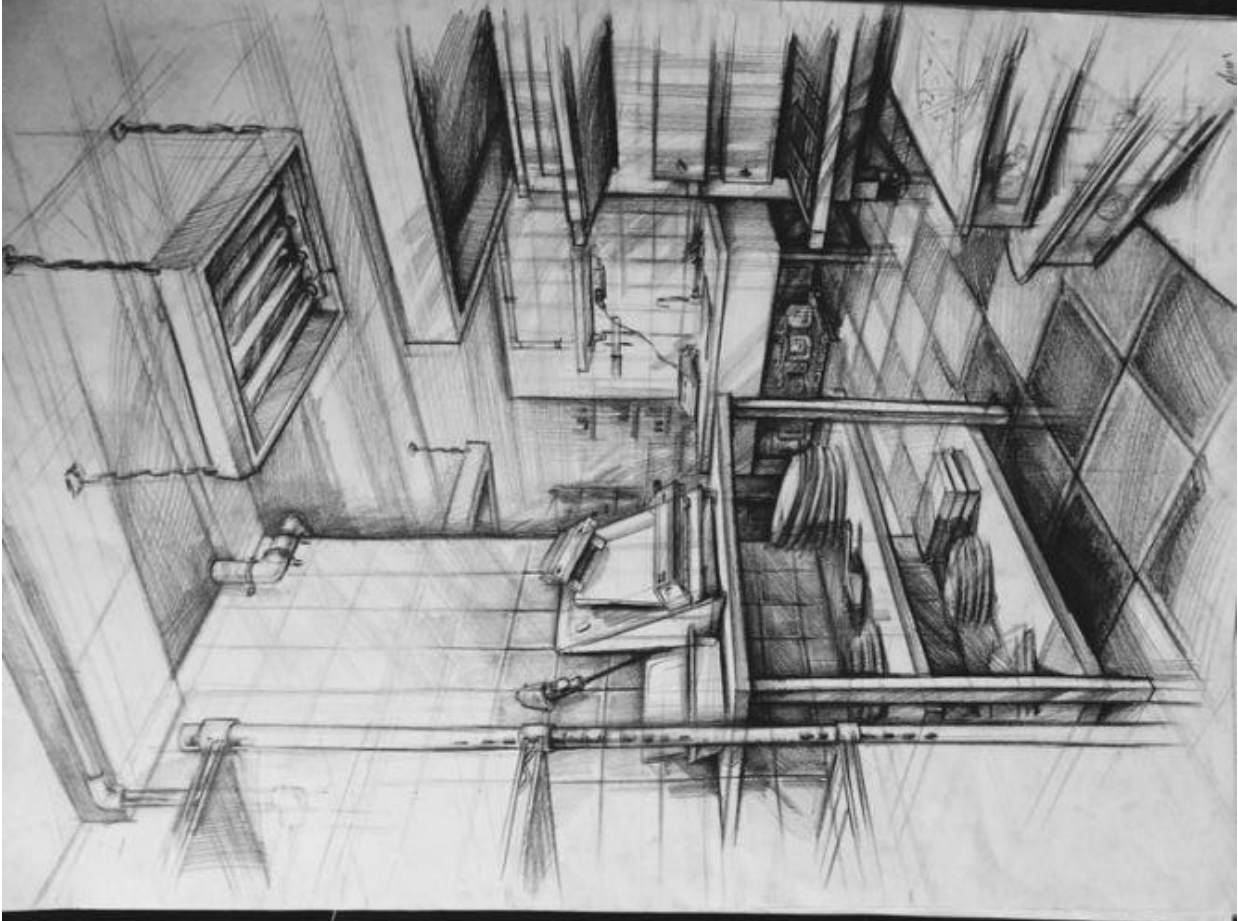
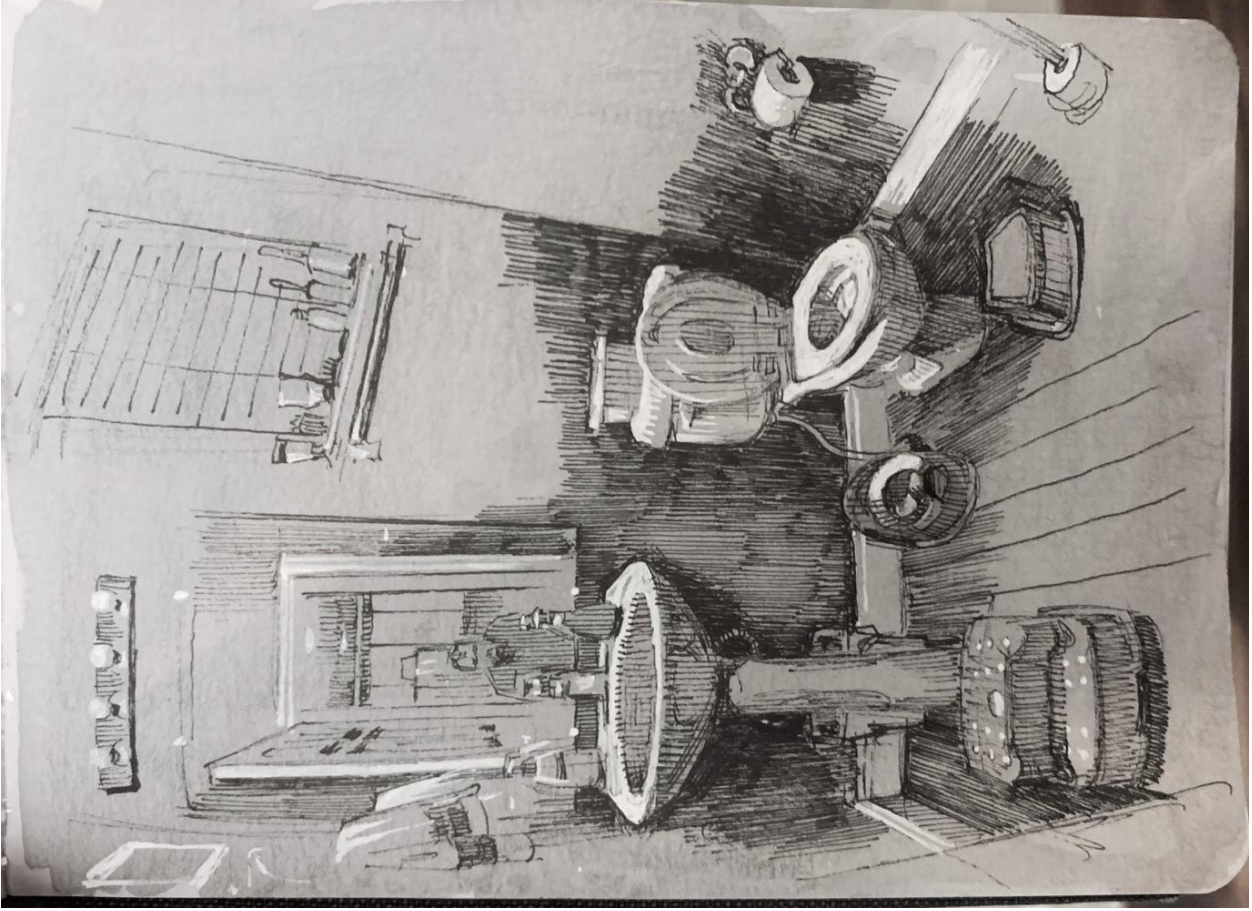





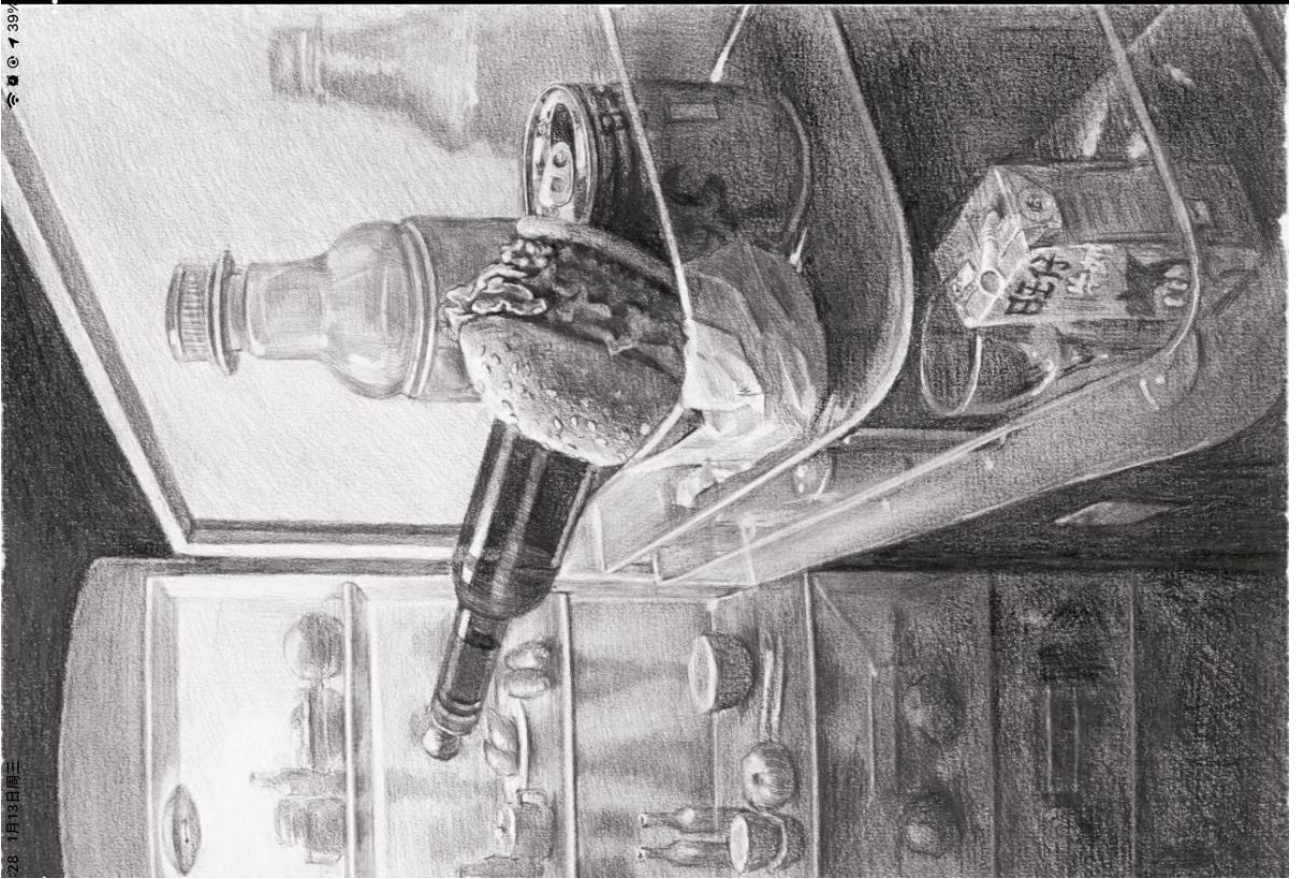

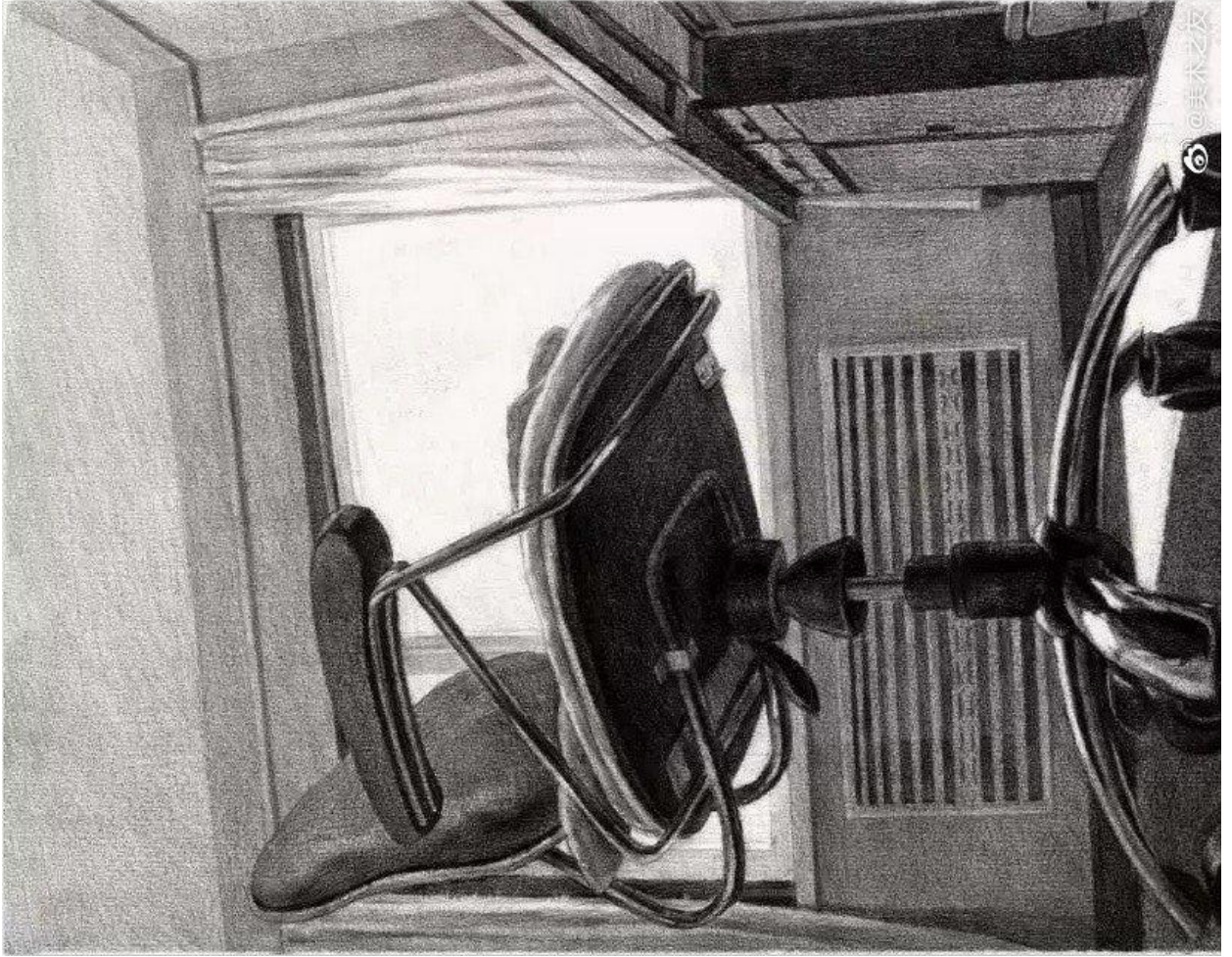



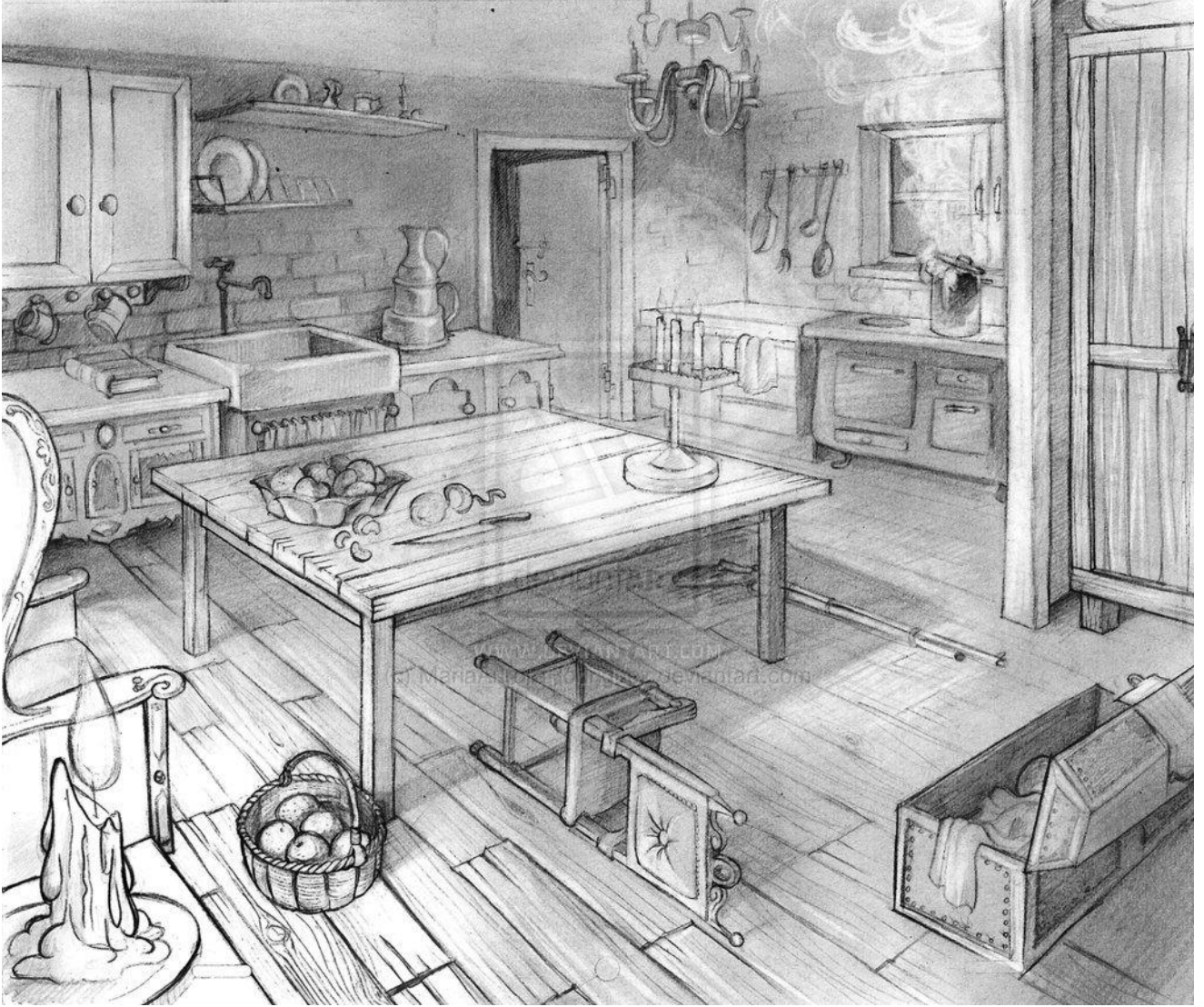

ÖRNEK İMGESEL ÇİZİMLERİ

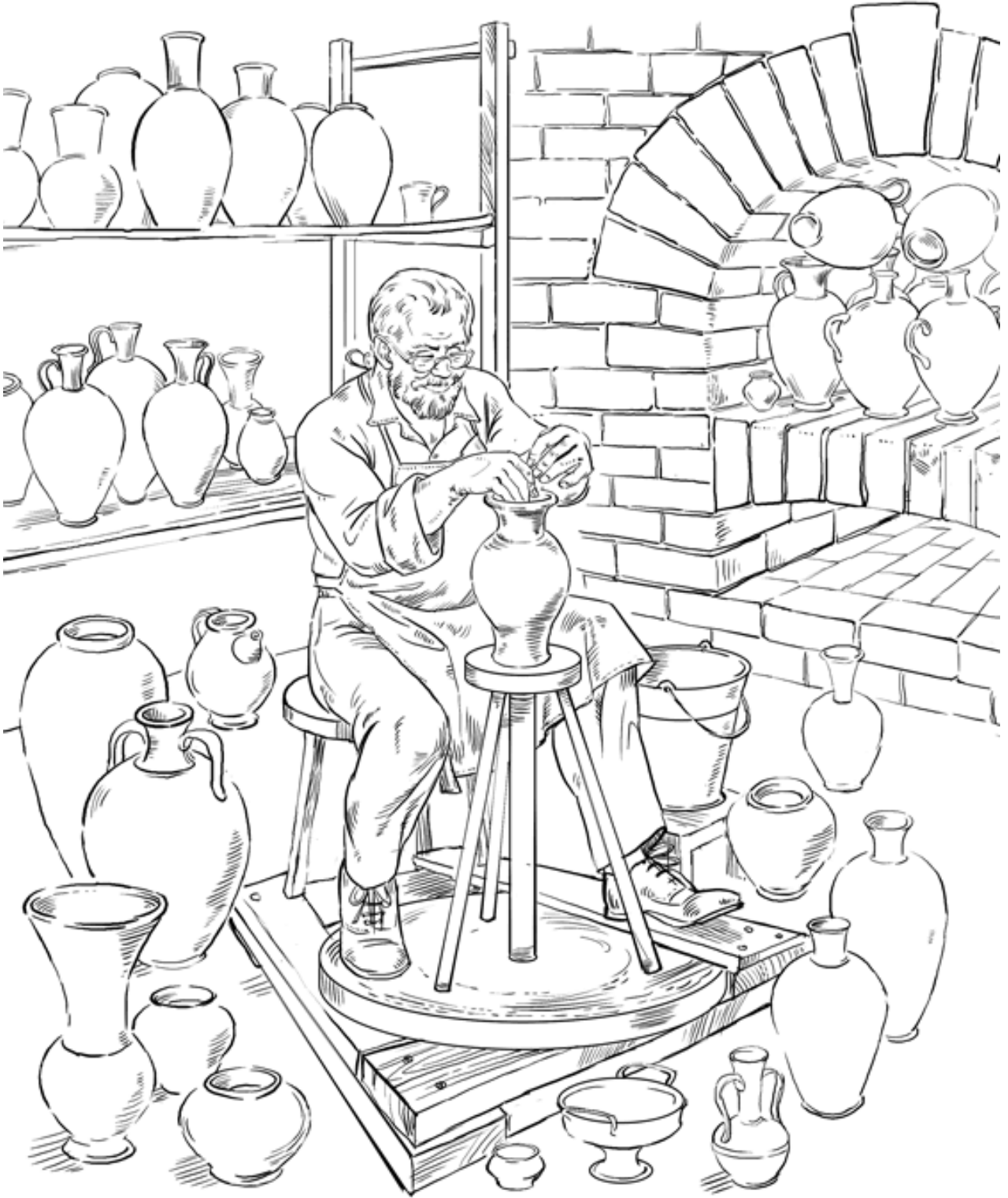

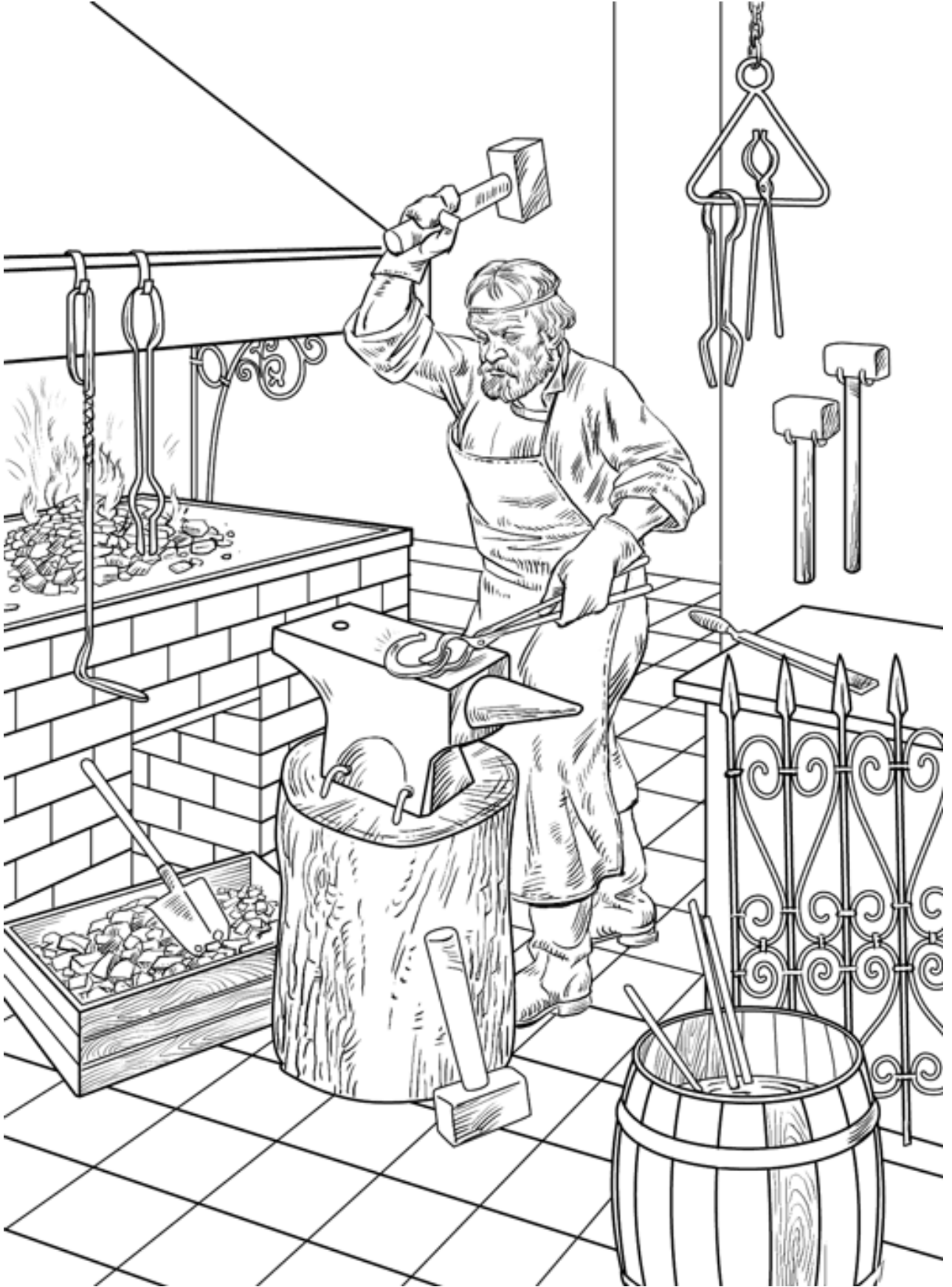

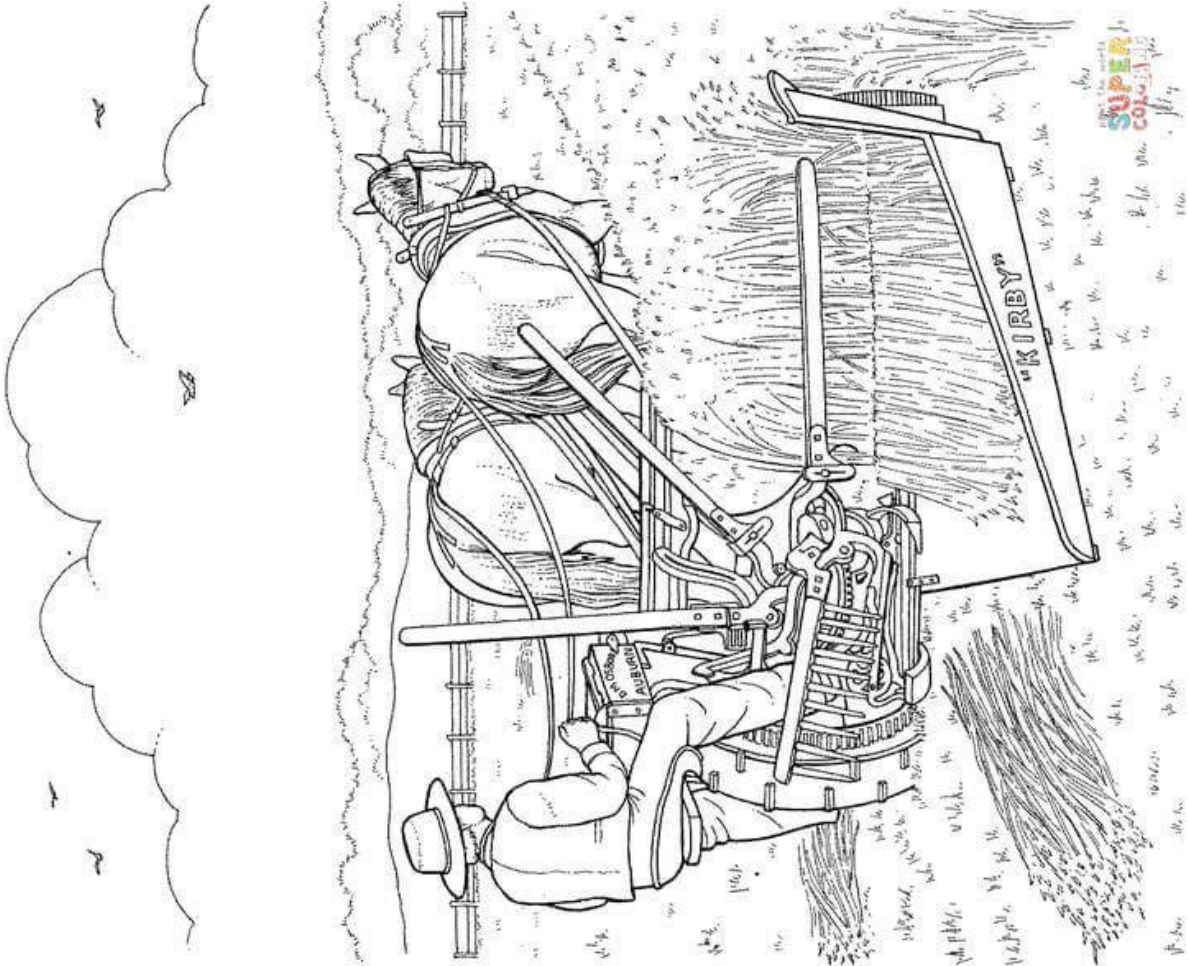

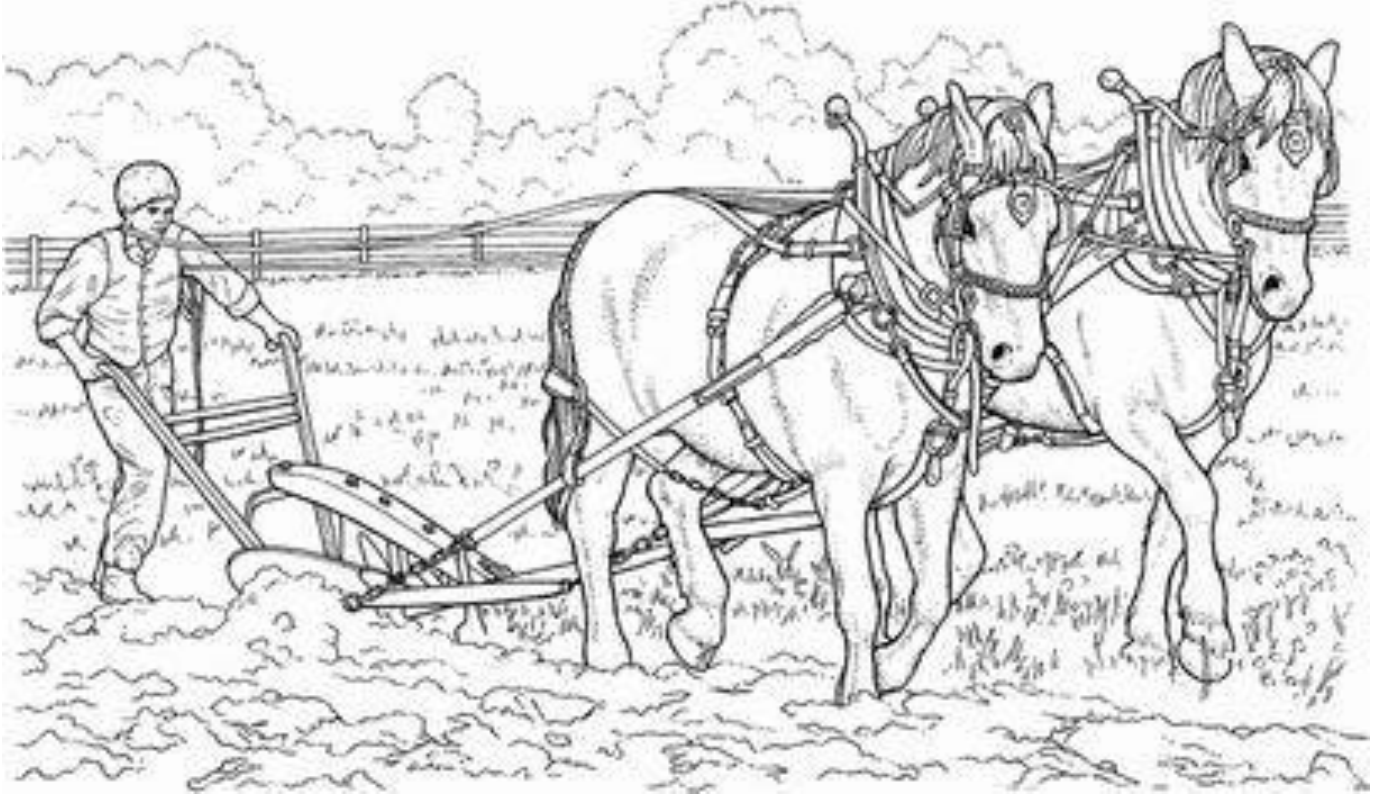
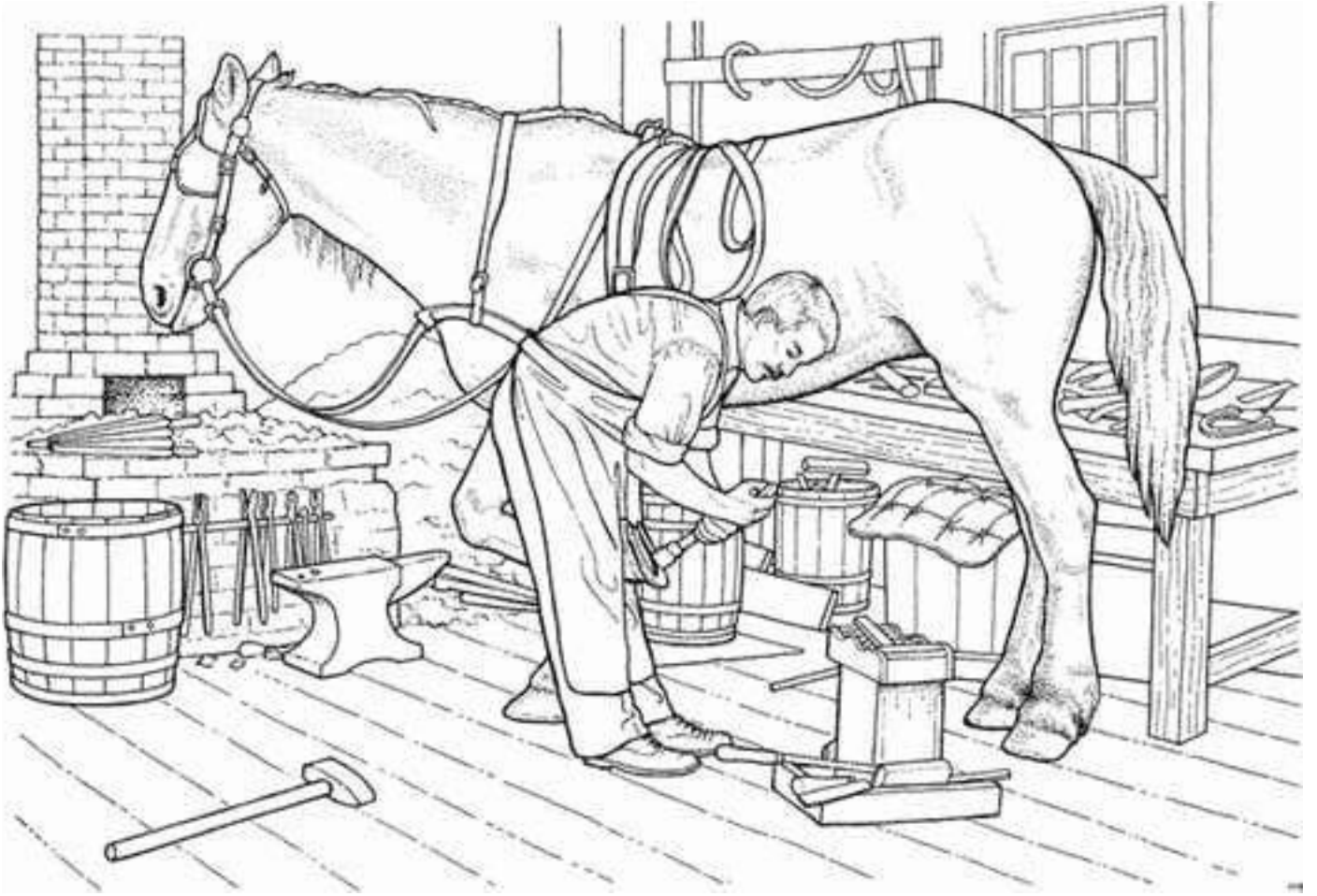









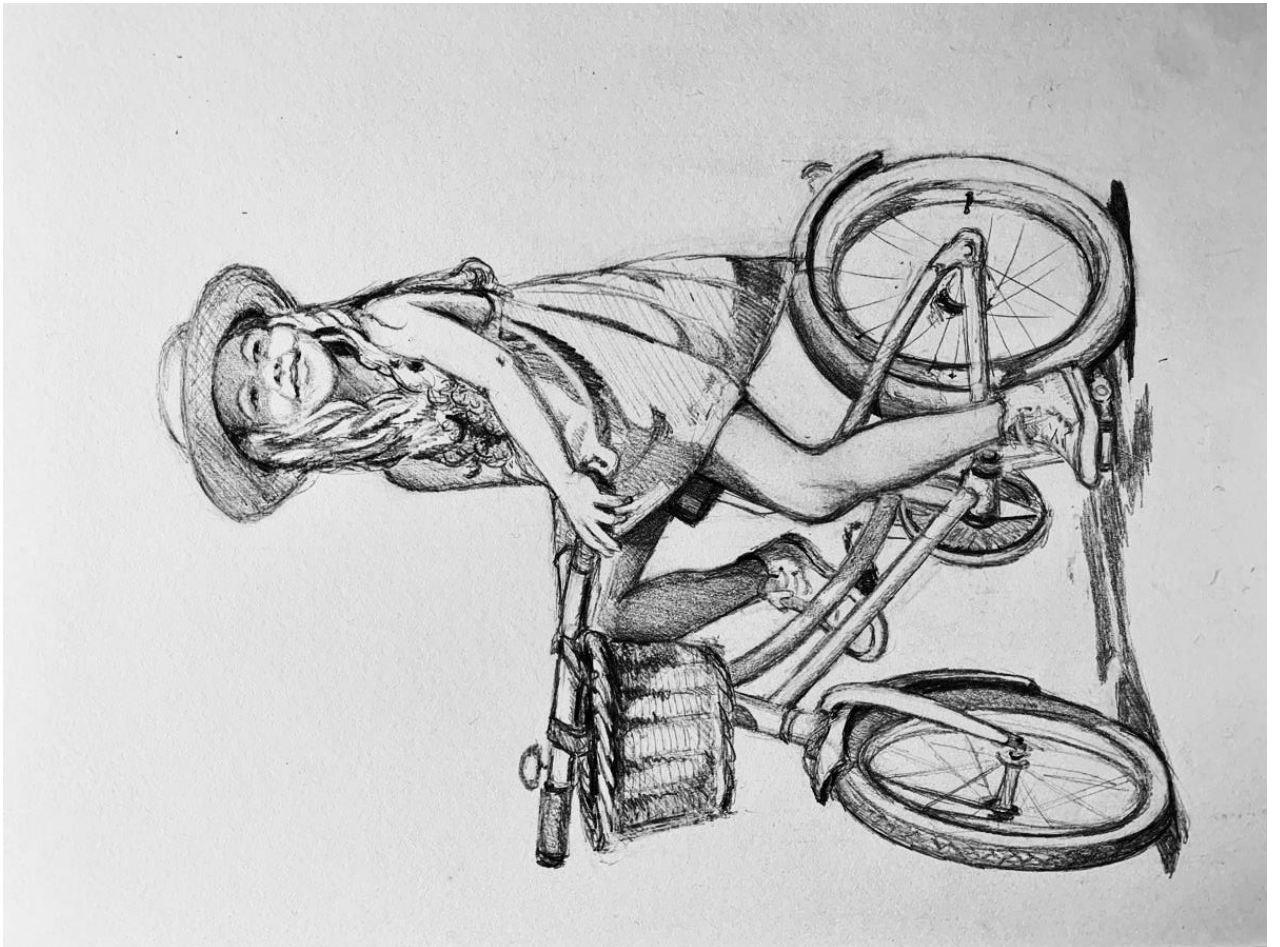



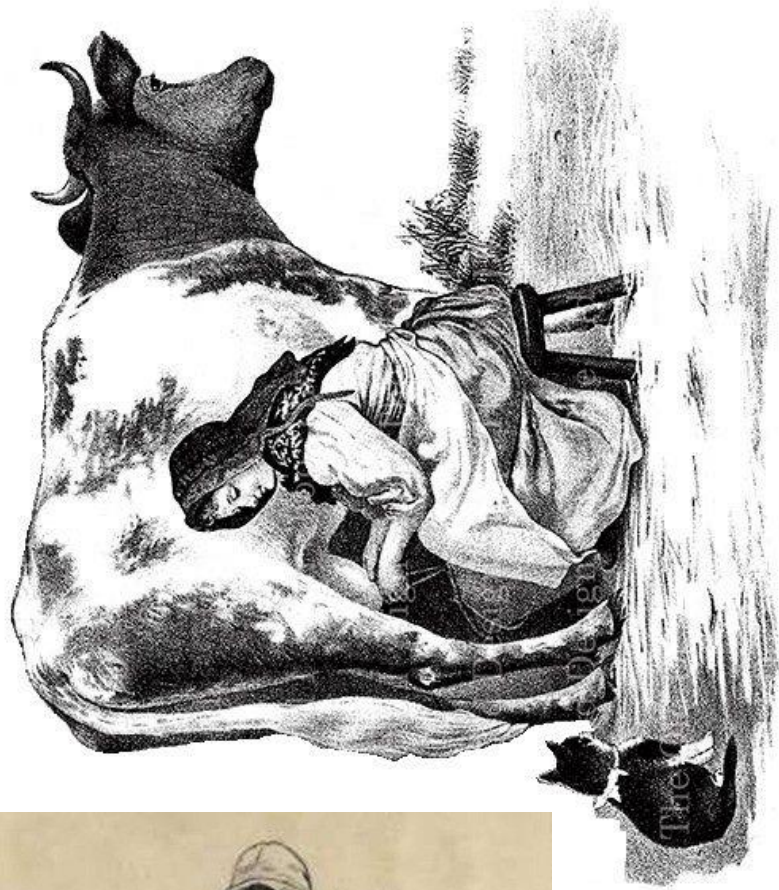

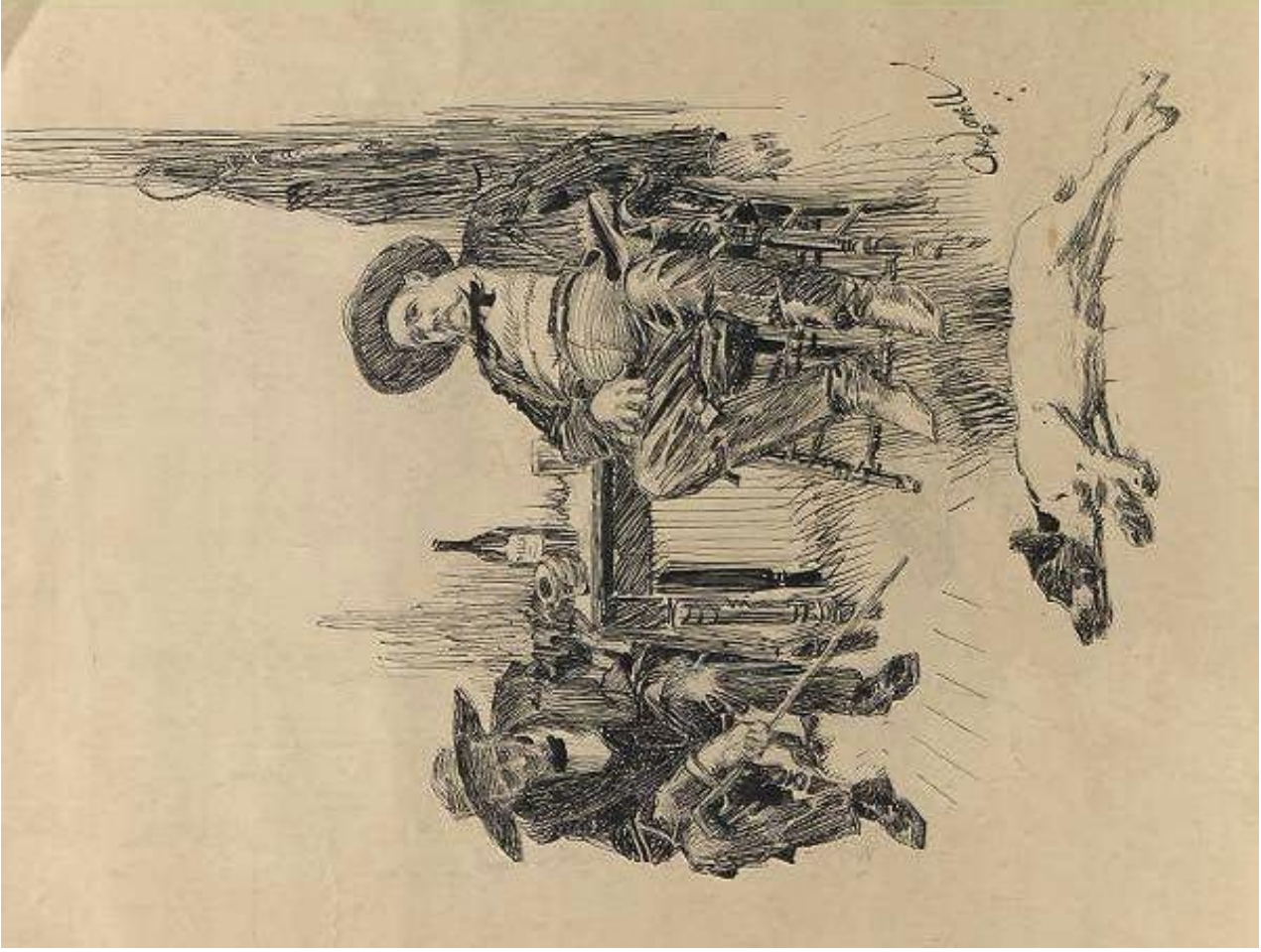









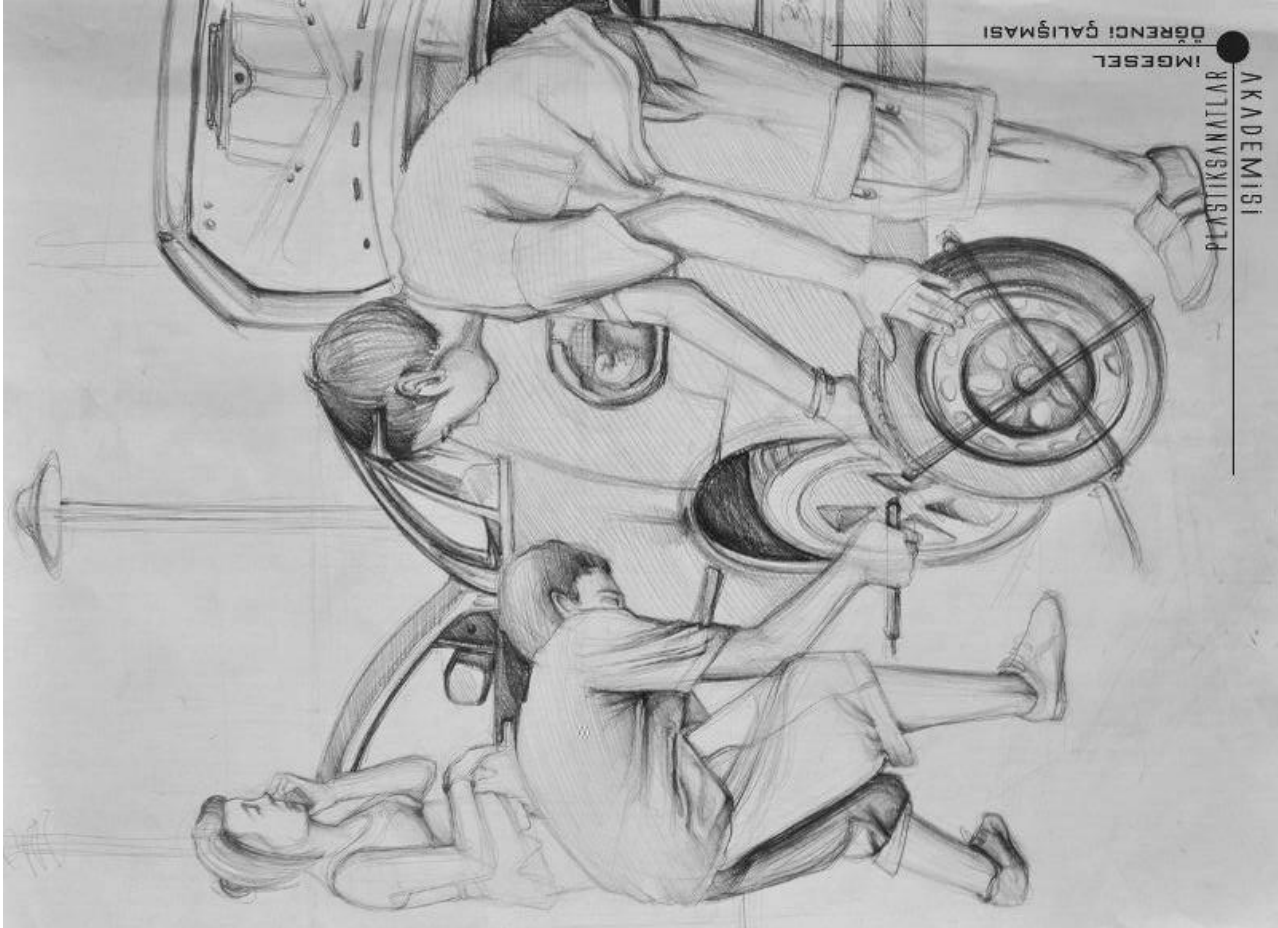

AKADEMİSİ  
YATIRIM VE İKİŞİMLER  
İMGESSEL  
ÖĞRENCİ GƏLİŐMƏSİ



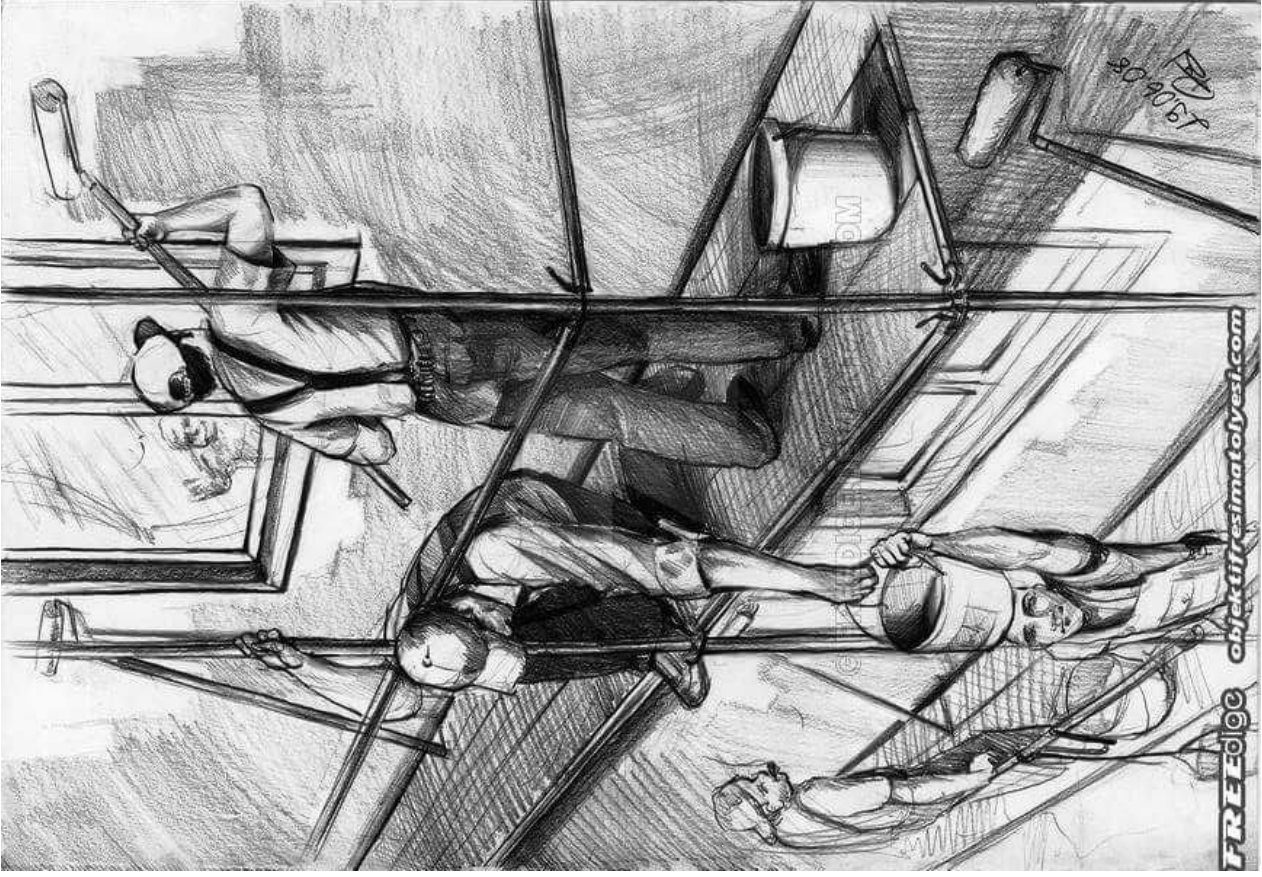



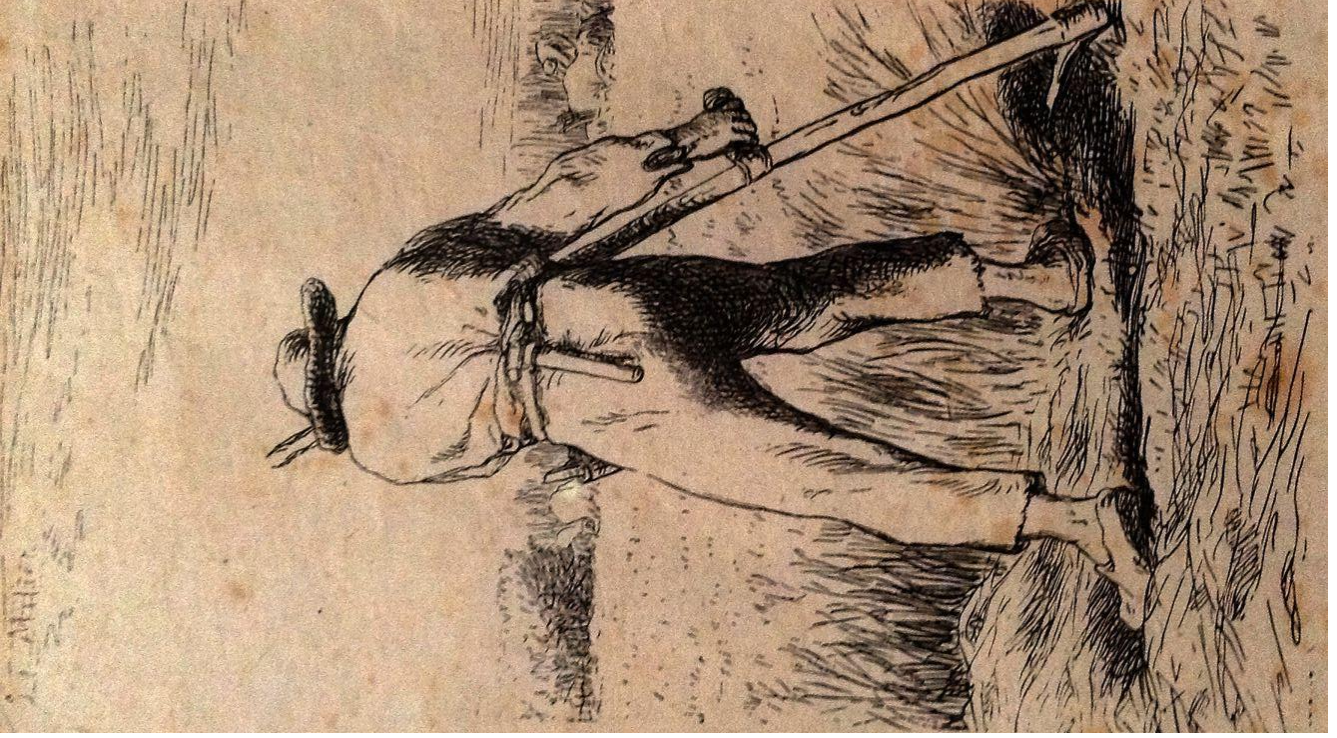

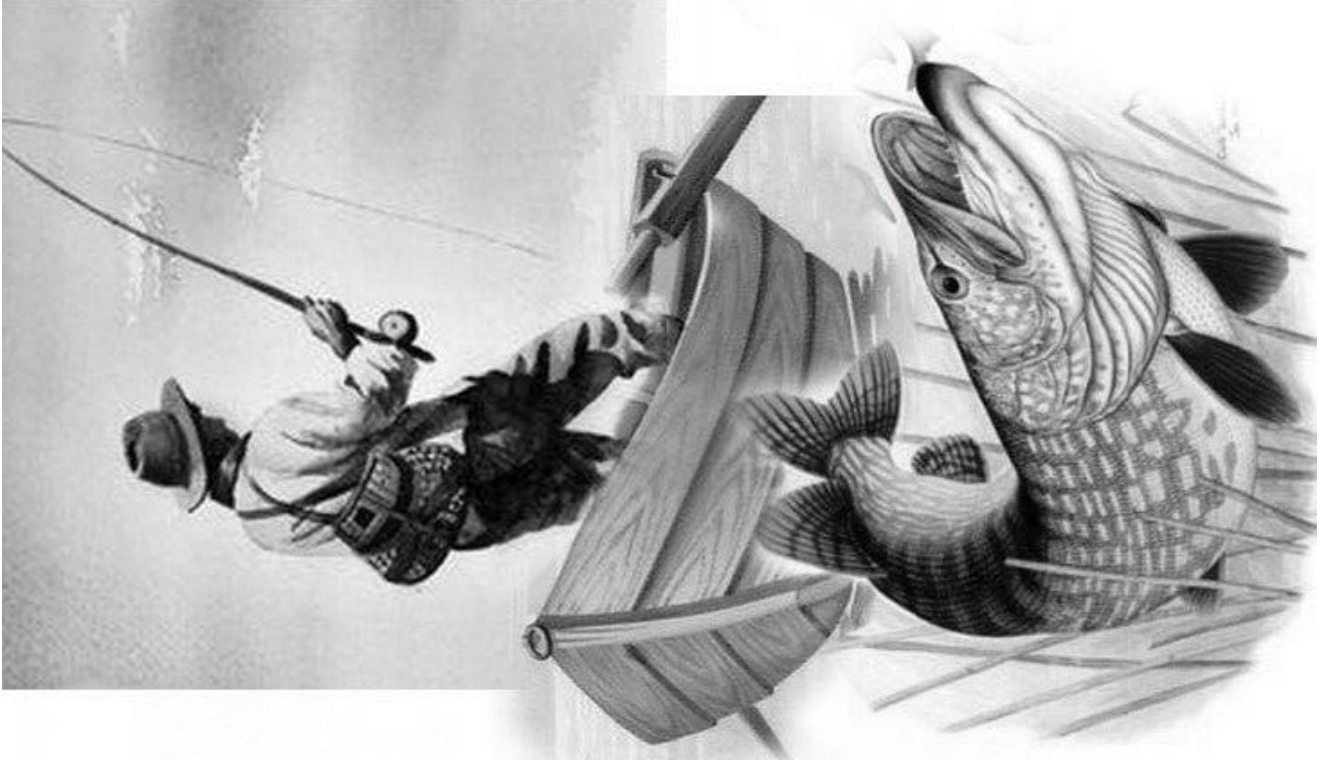





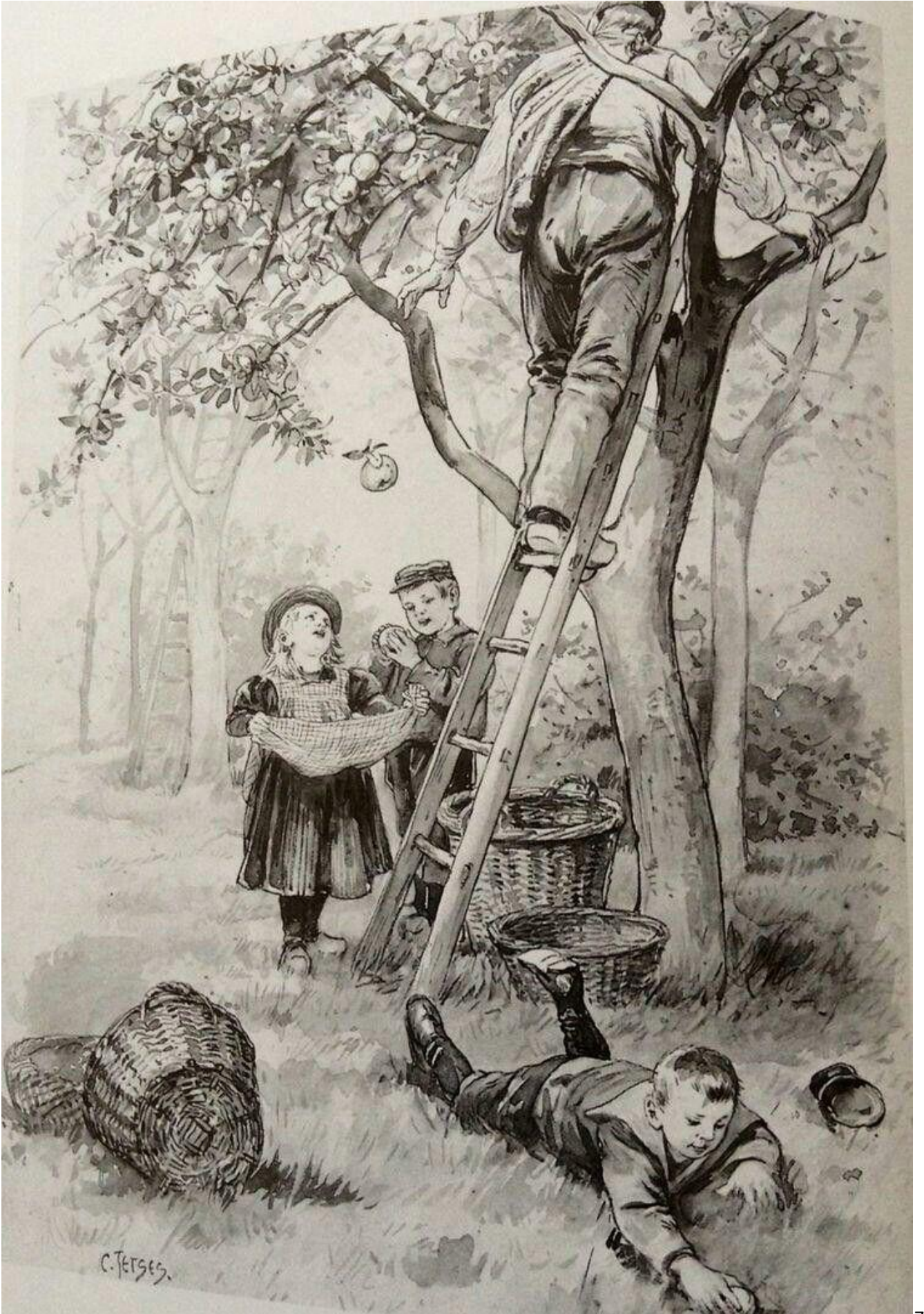

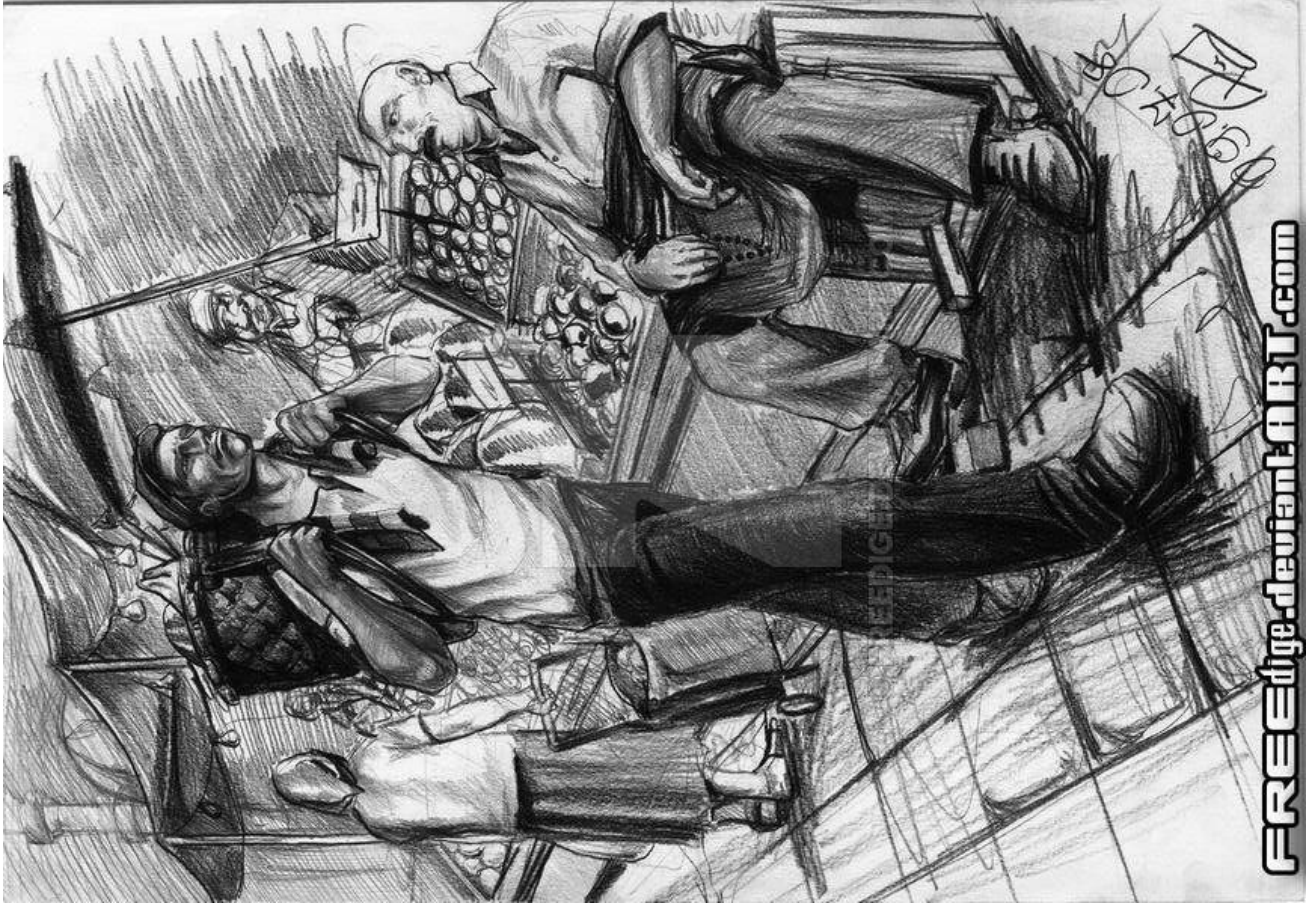

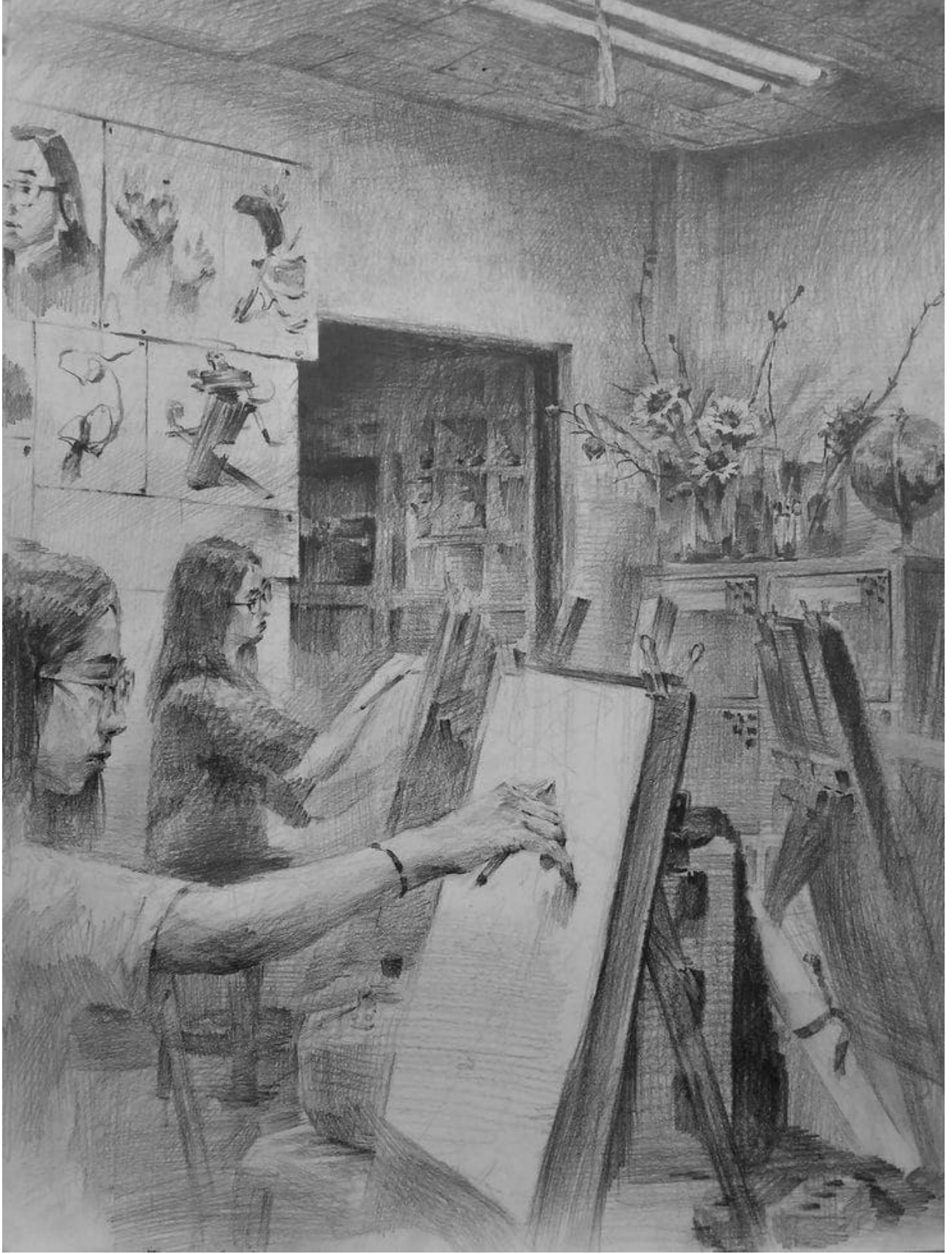

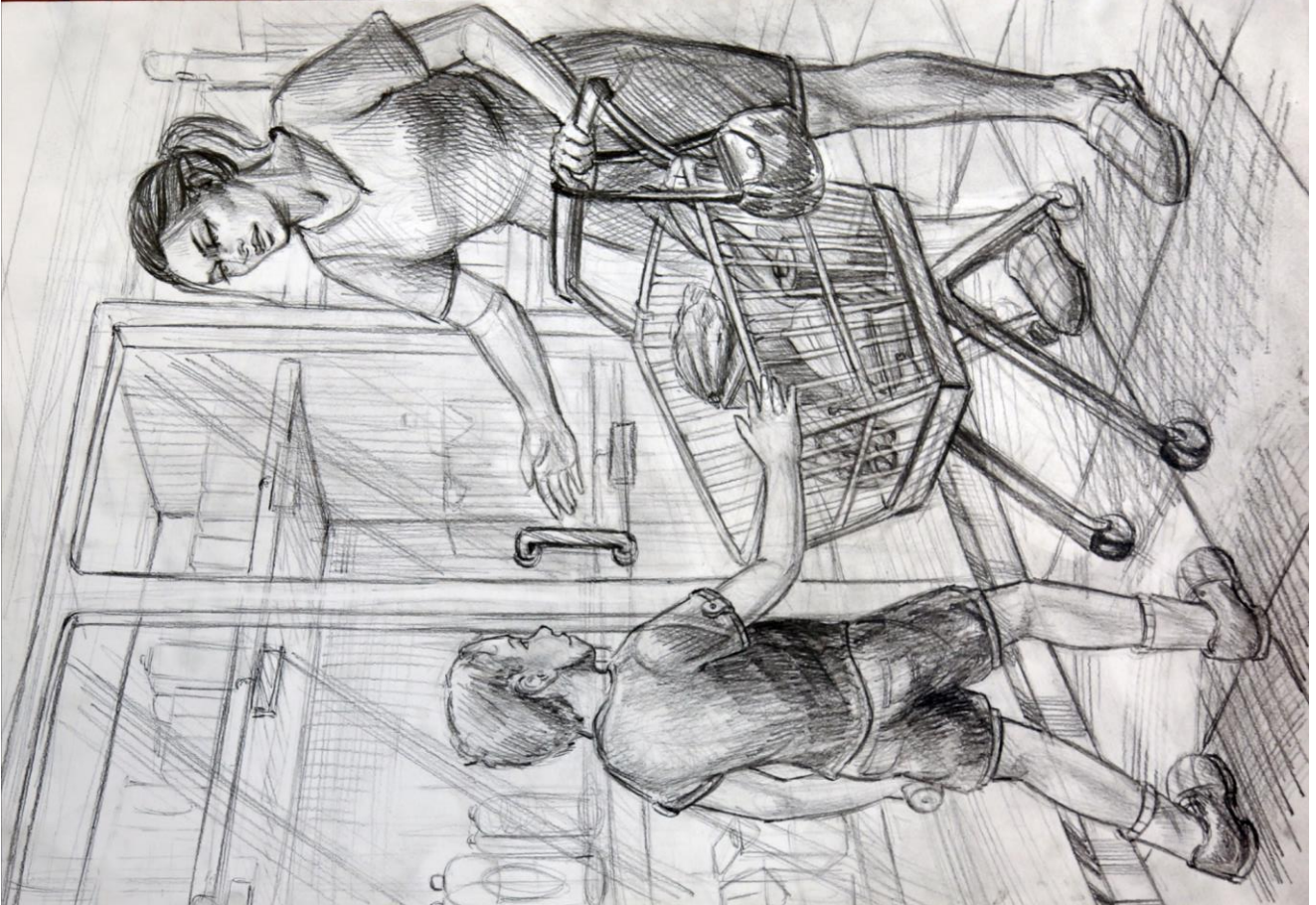
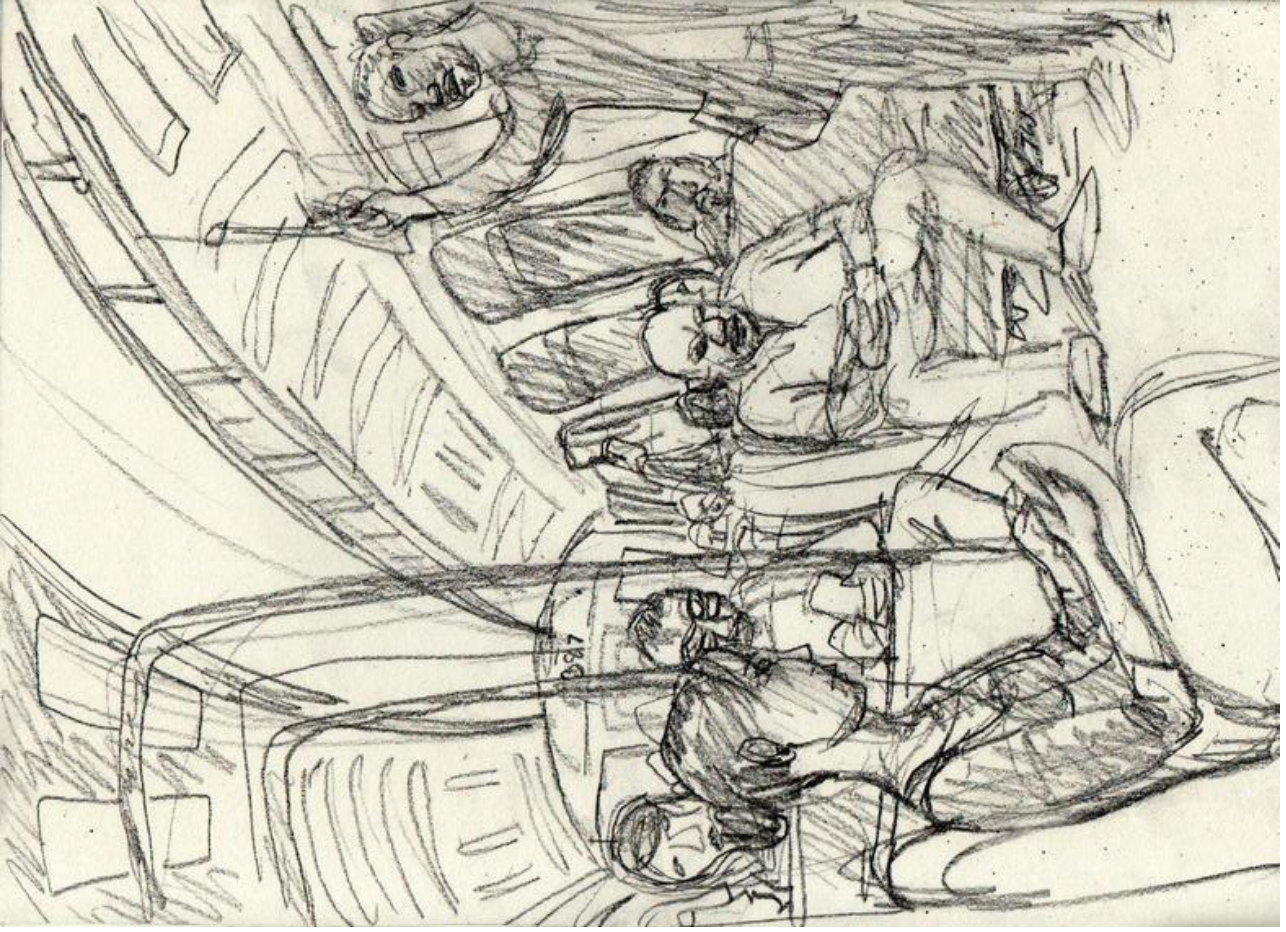

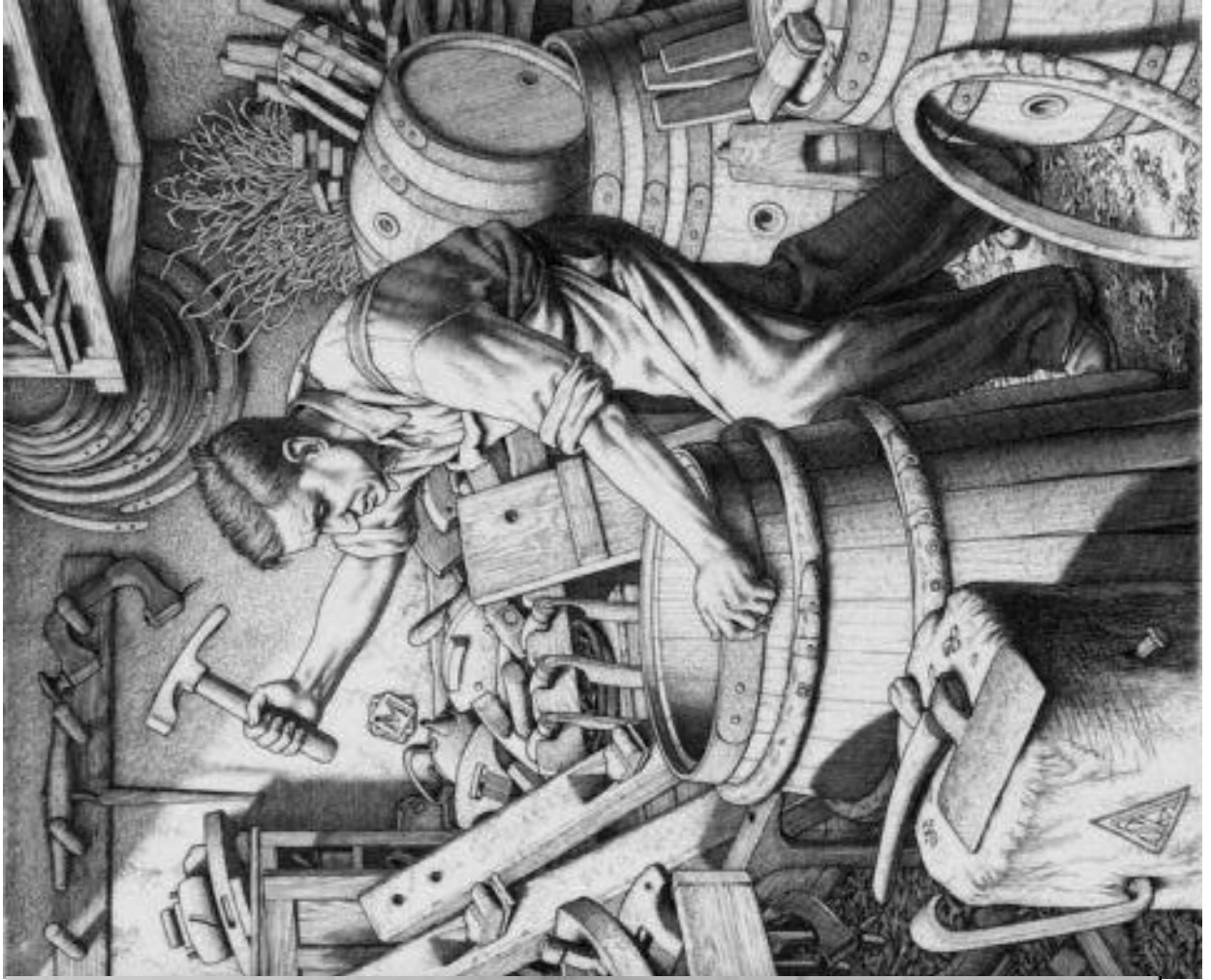









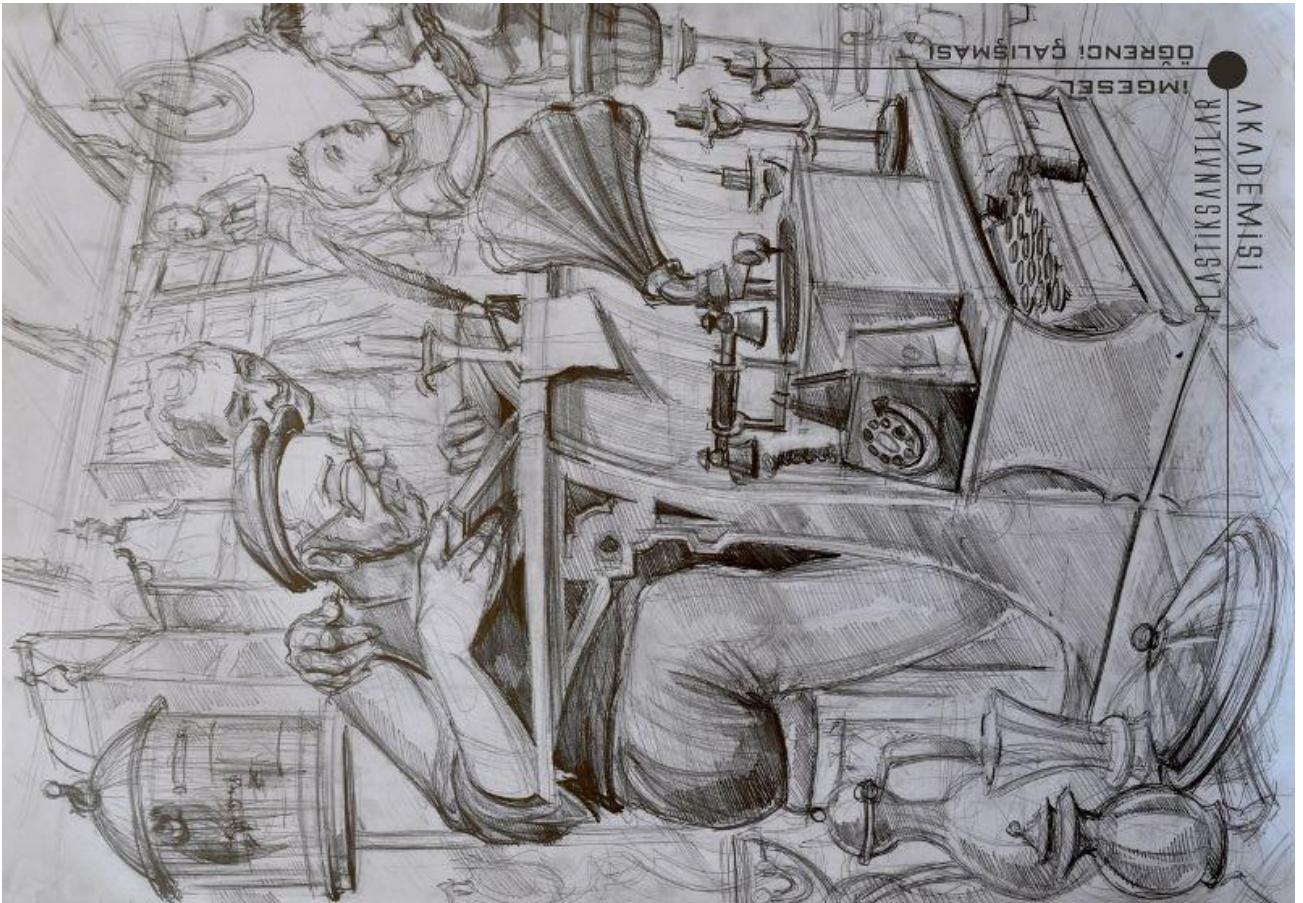

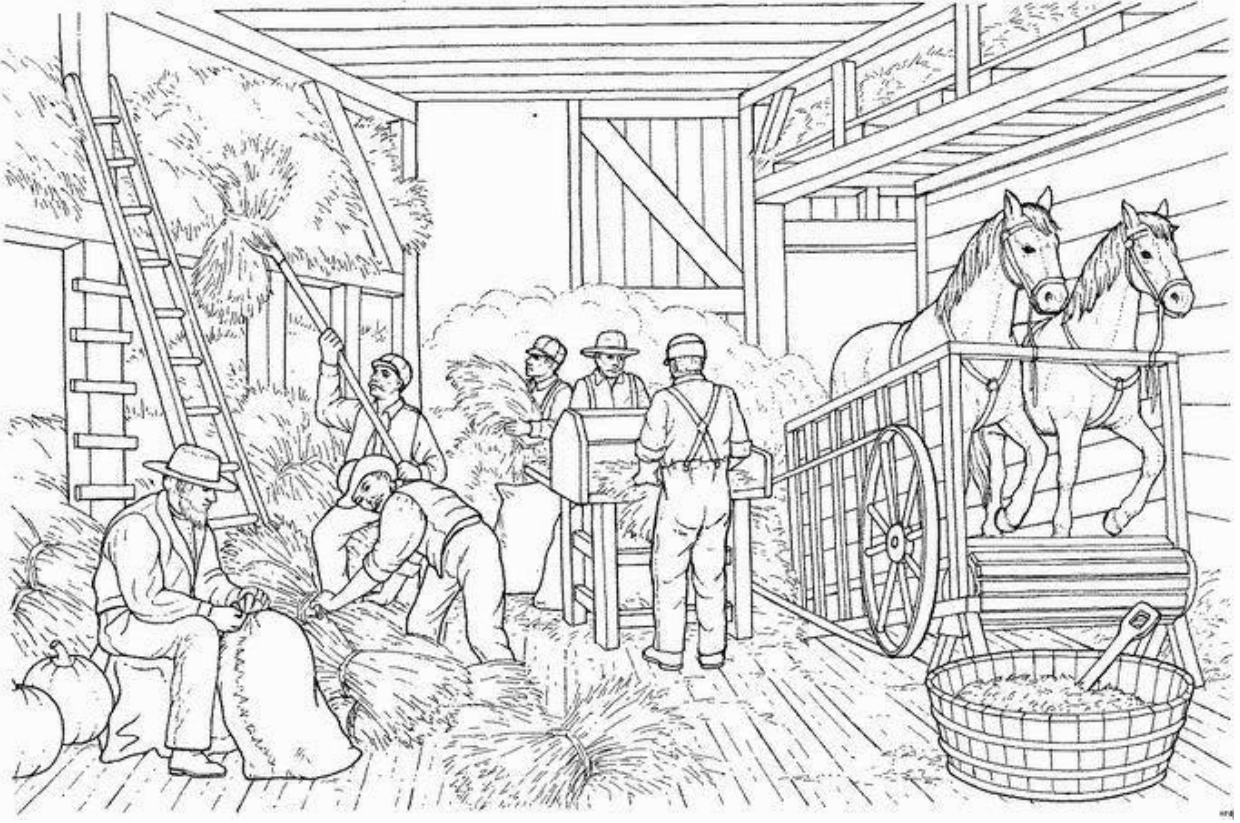









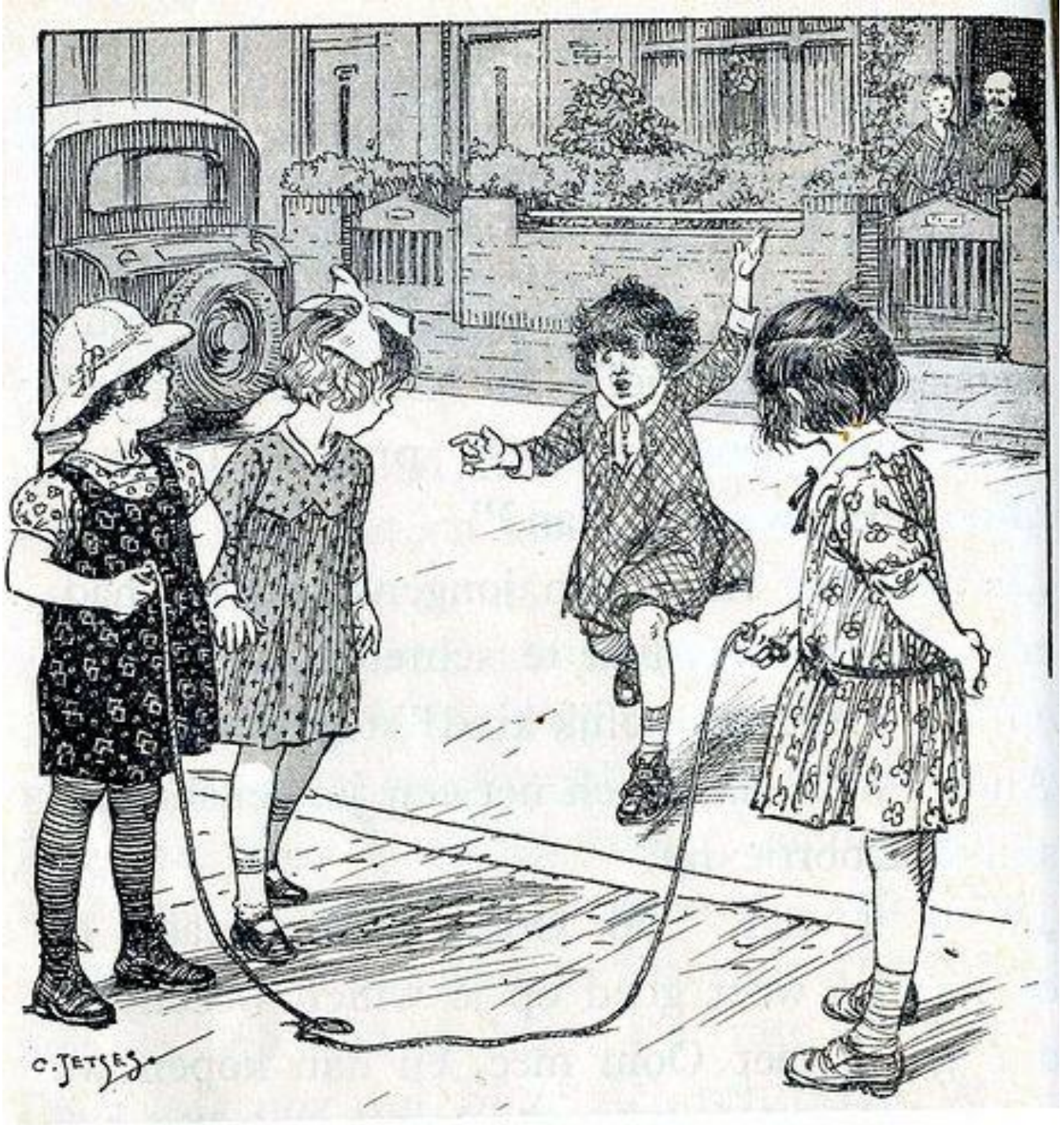





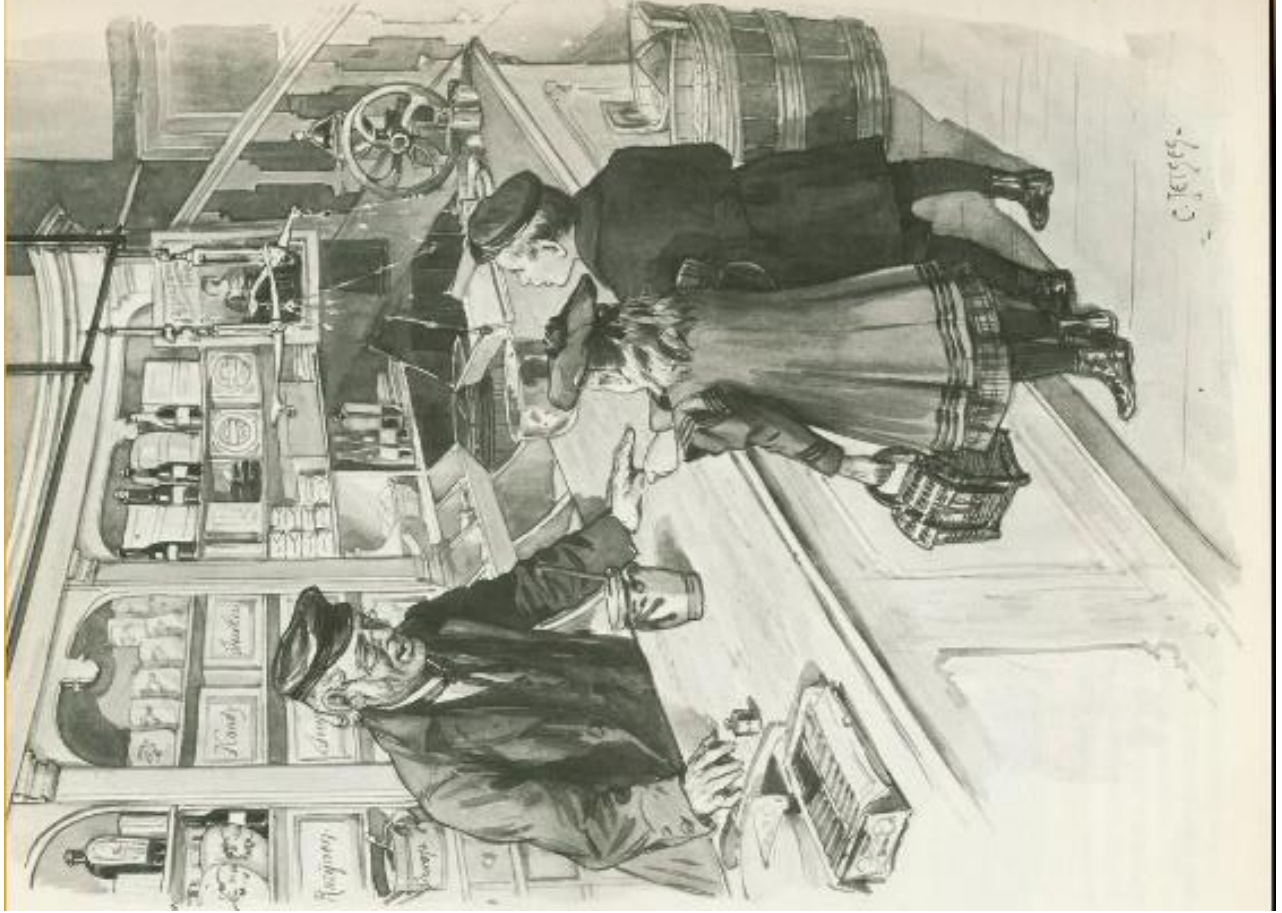



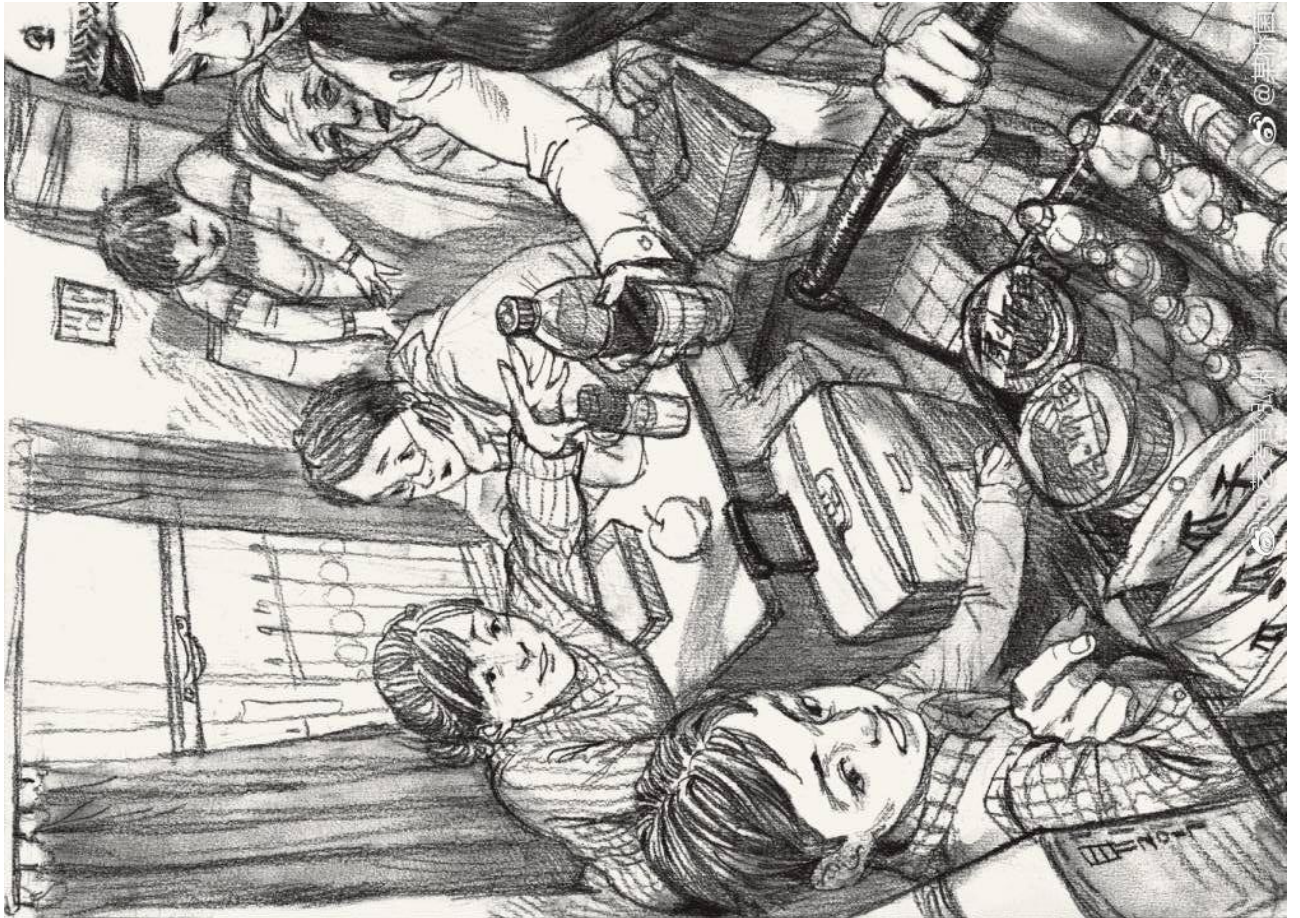



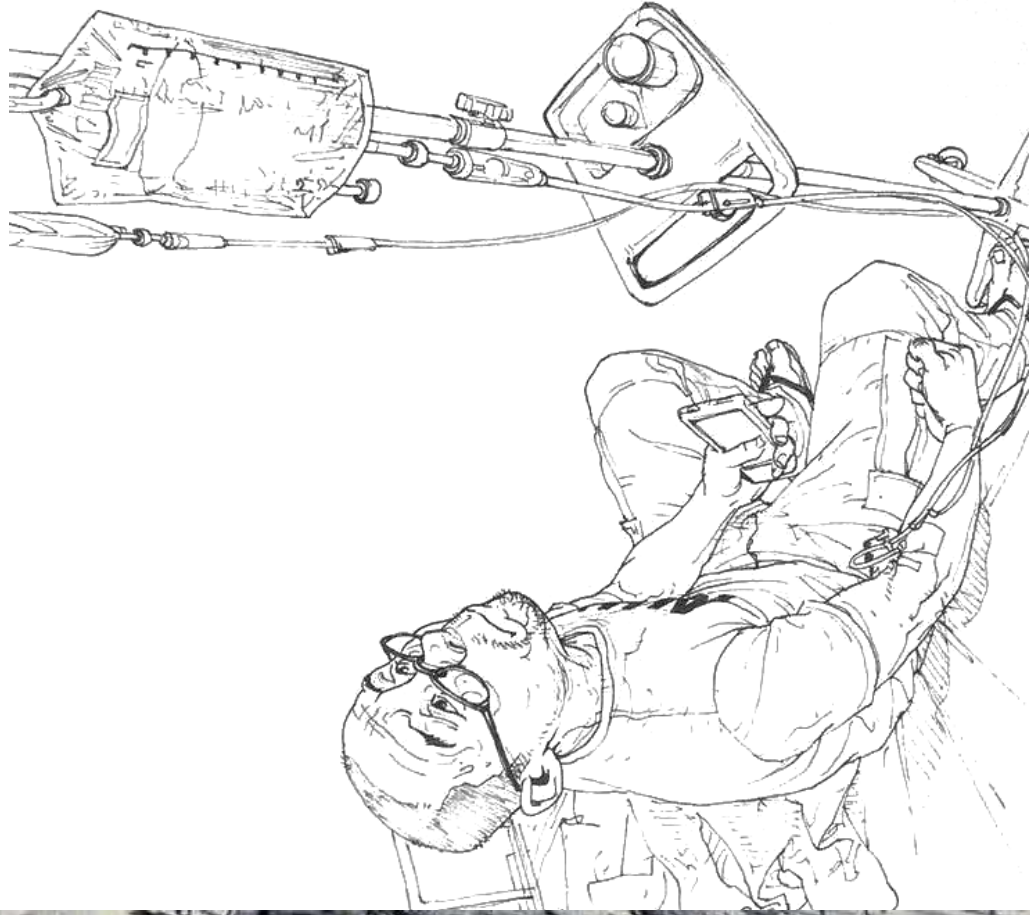



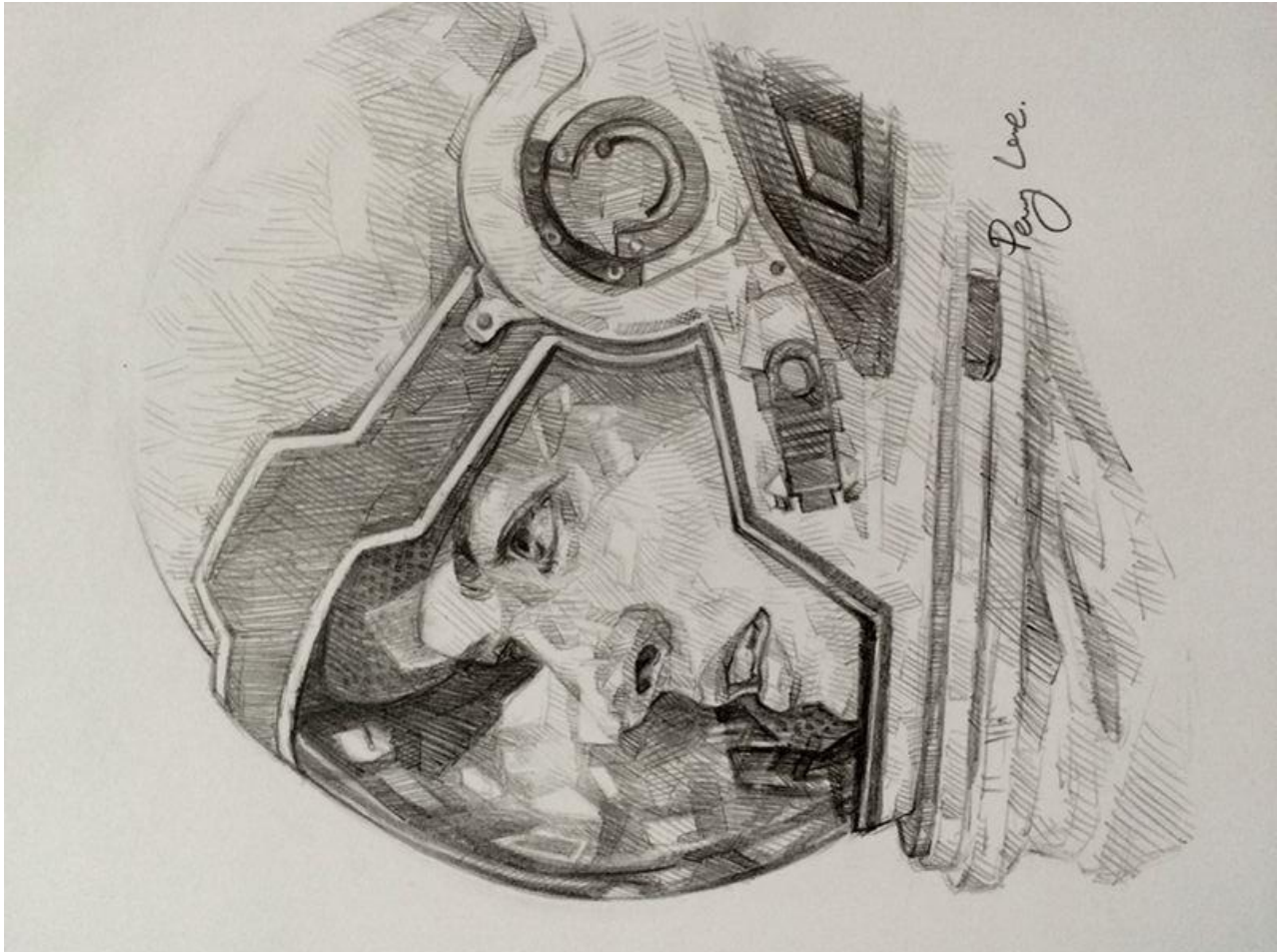



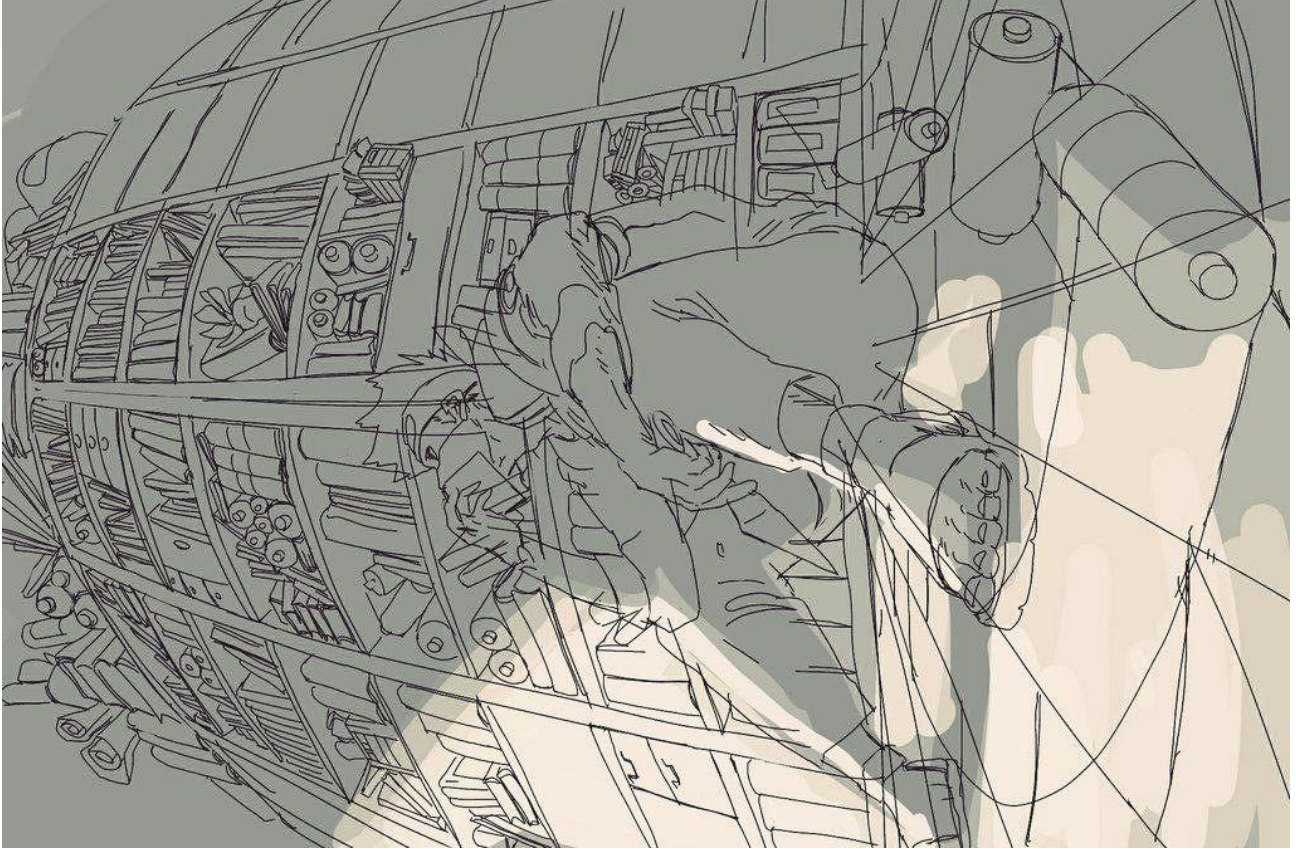
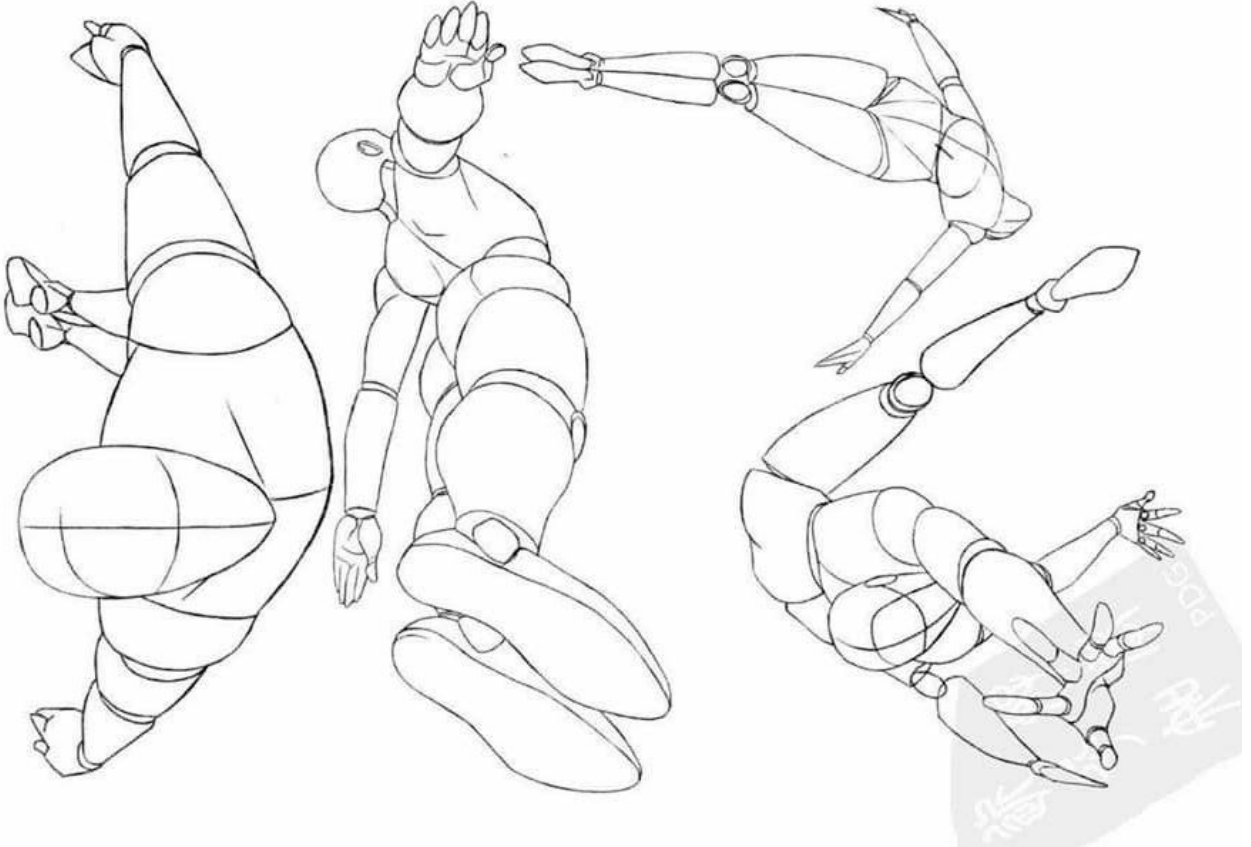

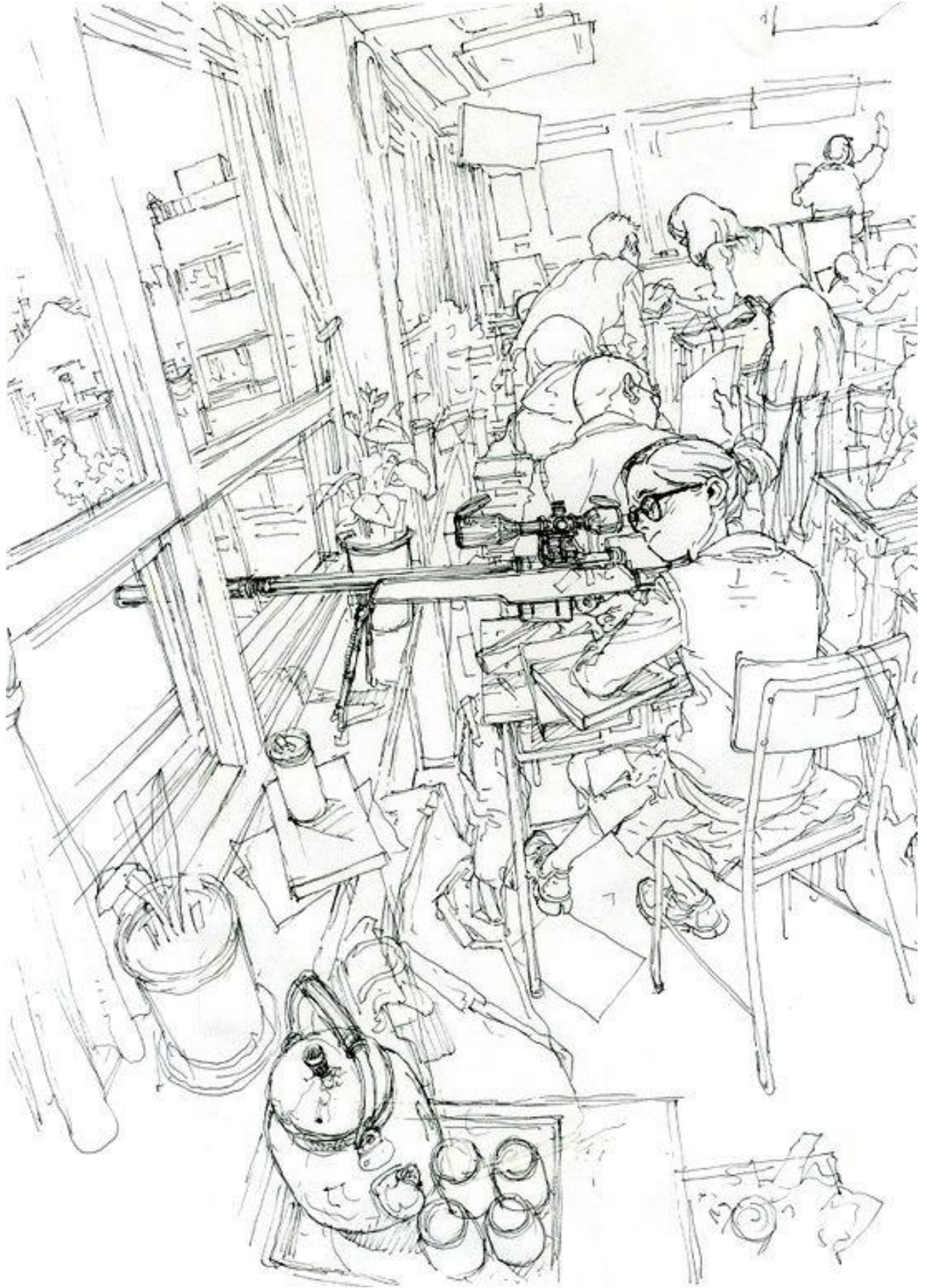

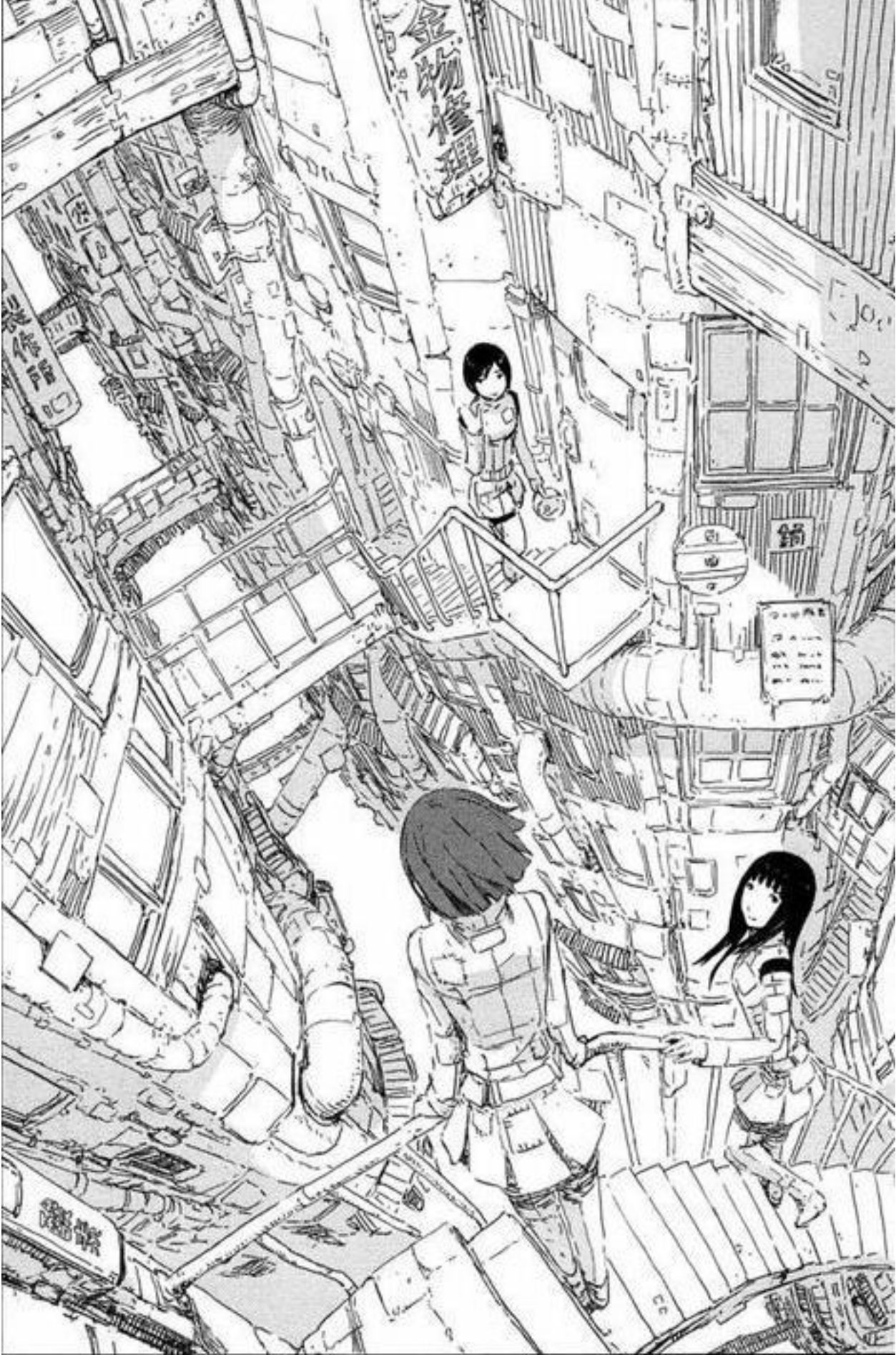

İMGESEL ALIŞTIRMALARI



